



CANCER
DIAGNOSTICS, INC

Results for Life

ORDERS@CANCERDIAGNOSTICS.COM



TOLL FREE: 1-877-846-5393 • FAX: 1-877-817 1716 • WWW.CANCERDIAGNOSTICS.COM

CANCER DIAGNOSTICS INC.
4300 EMPEROR BLVD-400 • DURHAM, NORTH CAROLINA 27703 • USA
CORPORATE HEADQUARTERS

© Cancer Diagnostics, Inc. All rights reserved. Printed in the USA.



ANATOMIC PATHOLOGY



Products for Anatomic Pathology

#14



Results for Life



CANCER
DIAGNOSTICS, INC.

Products for Anatomic Pathology

CONTACT INFORMATION:

Cancer Diagnostics, Inc.
4300 Emperor Blvd. - 400
Durham, NC 27703, USA

WORLDWIDE DISTRIBUTION:

Outside of the U.S.? Contact us for the distributor in your area. CDI is currently shipping to over 40 countries.

OPERATING HOURS:

Monday through Friday 8:00 a.m. to 5:30 p.m (EST)

Orders placed by 2:00 Eastern time will ship on the day received. All orders are shipped from one of five distribution centers. Next-day air delivery is available upon request. (Please note: CDI does not ship hazardous material by air.) There is no minimum order.

TECHNICAL INFORMATION

To request a safety data sheet (SDS) or obtain Technical information for our products.

Cancerdiagnostics.com
TS@cancerdiagnostics.com
1-877.846.5393 (x703)

1-877.846.5393 • cancerdiagnostics.com • orders@cancerdiagnostics.com



Products for Anatomic Pathology







Results for Life

HISTORY

Founded in 1998, CDI developed the first commercially available 7-dye color kit for marking tissue margins, CDI's® Tissue Marking Dyes; and today offers one of the industry's largest portfolio of anatomic pathology products to over 3,500 laboratories worldwide with shipping locations throughout the United States.

Our mission is to provide extraordinary value for anatomic pathology laboratories and patients through a wide variety of reliable, cost effective solutions delivered with exceptional service and integrity.



Durham, NC  | Los Angeles, CA  | Seattle, WA  | Little Rock, AR  | Philadelphia, PA 
HQ  Regional Warehouses 



”

Our passion is improving the customer experience with better products and service. Reliable products, easy ordering, on-time deliveries, value and guaranteed satisfaction.

QUALITY

Welcome to Cancer Diagnostics, Inc. (CDI)

We have been privileged to work with thousands of organizations since 1998. I'd like to thank you for the work that you do in Anatomic Pathology and the vital role you play in providing better patient care.

We love to listen and learn from our customers and work to provide choices that give the best options for optimal work flow routines and diagnostic results.

We are passionate about creating, developing and providing products for Anatomic Pathology.

From our first product 20 years ago, CDI's Tissue Marking Dyes® to our current 3000+ product line, we're honored to be your current or potential supply partner.



Patrick O'Neill
Founder, CEO



”

“We're deliberate with our quality and passionate about manufacturing. Ensuring our processes are effective and consistent for both current and new products with the highest quality is our focus.”

Jonathan D. Kent, Ph.D.
Director of Manufacturing and Product Development



Cancer Diagnostics, Inc. is compliant to ISO 13485 standards



Founded
in 1998

Nationwide
Sales Team

3000+
Products
3,500
Customers

Multiple
U.S.
Shipping
Facilities

GUARANTEED



DEDICATED SALES TEAM

CDI has a nationwide outside sales team. Each customer has a dedicated Territory Sales Manager; a single point of contact that ensures a cohesive and consistent level of service.

DEDICATED CUSTOMER SERVICE

Our customer service team focuses on helping you get your product in the most efficient way possible and responding quickly to any issues that may arise.



Building Relationships



TECHNICAL SUPPORT

Technical questions can be directed by calling **1-877.846.5393 (x703)** or emailing **TS@cancerdiagnostics.com**

WEBSITE

In addition to online ordering; order history, price quotes, tracking information, invoices, and other important account information are all viewable in one secure location in real time through customer portal via **cancerdiagnostics.com**.

All SDS are searchable and downloadable.

Best-in-class e-commerce technologies.



Seamless Integration

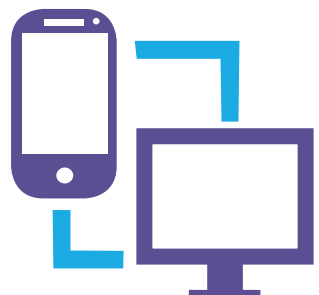

CONTACT INFORMATION AND HOURS

OPERATING HOURS:

Monday through Friday 8:00 a.m. to 5:30 p.m (EST)

Orders placed by 2:00 Eastern time will ship on the day received. All orders are shipped from one of five distribution centers. Next-day air delivery is available upon request. (Please note: CDI does not ship hazardous material by air.) There is no minimum order.

CONTACT INFORMATION:

Cancer Diagnostics, Inc.
4300 Emperor Blvd. - 400
Durham, NC 27703, USA

WORLDWIDE DISTRIBUTION:

Outside of the U.S.? Contact us for the distributor in your area. CDI is currently shipping to over 40 countries.



Easy Communication



ORDERING INFORMATION

PHONE: 1-877-846-5393

FAX: 1-877-817-1716

EMAIL: orders@cancerdiagnostics.com

WEBSITE: www.cancerdiagnostics.com

EDI: GHX (Electronic Trading Exchange) U.S. healthcare organizations that are part of the GHX network can transact with Cancer Diagnostics through the GHX electronic trading exchange Please include the Following information whenever possible:

- Catalog number
- Brief description of the product
- Quantity
- Product price
- Purchase order number
- Phone number
- Name of person placing the order
- Name of facility

Prices are subject to change without notice. Visa, Mastercard, AMEX, and Discover are accepted.

Terms available

***Don't see a product in our catalog? CDI may offer what you're looking for as a non-stock item or custom offering.**

Ordering Simplified



SHIPPING

Orders are shipped FOB Origin, pre-pay and add via common carrier (UPS or FedEx). If requested, we can use your account number or the carrier of your choice and also ship on your third-party freight accounts. Charges vary with the destination, weight and content, and are available upon request at order entry and are indicated on the invoice.

FREIGHT CLAIMS

CDI ensures that all shipments leave the warehouse in good condition. All shipments leave with a packing list indicating shipment contents and quantities. Should you receive a damaged or incomplete shipment, do not accept the shipment until the delivering carrier has noted "DAMAGE" or "INCOMPLETE" on both copies of the freight bill. Immediately contact CDI Customer Service to arrange for replacement product and get assistance in processing a freight claim with the delivering carrier.

Shipping Made Easy

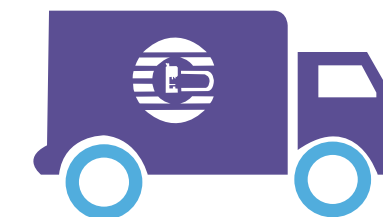

RETURNED GOODS POLICY

All products are covered by the following Total Quality Assurance policy which states: If you are not completely satisfied with the quality of our products, you may return them to us for a refund or replacement. CDI's liability is limited to a product refund or replacement. Please obtain a Return Goods Authorization (RGA) number from Customer Service prior to the return of a product.

Returns, which are not caused by unsatisfactory product performance, must be made within 30 days of delivery and will be subject to a 25% restocking/processing fee.

STANDING ORDER ARRANGEMENT

A standing order is the amount and variety of products you would like to have delivered automatically on any date you choose. Standing orders are easy to initiate and can be placed on hold, changed or cancelled at any time. Any product, and any quantity can be placed on standing order to ensure a consistent and predictable supply for your lab.

100% Satisfaction

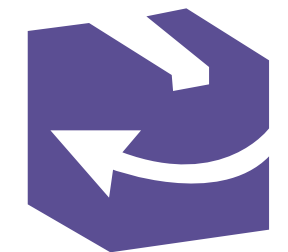

CONTENTS

This symbol refers to MOHS (and Frozen Section) related products throughout the catalog



1

GROSSING, SPECIMEN PROCESSING



65

FIXATIVES, DECALCIFERS, ALDEHYDE CONTROL



77

PRE-FILLED JARS



89

DEHYDRANTS AND CLEARING AGENTS



99

CASSETTES



121

EMBEDDING, SECTIONING MICROTOMY



157

MICROSCOPE SLIDES, COVERGLASS AND MOUNTING MEDIUM



177

STORAGE, TRANSPORT AND DISPOSAL



195

PROTECTION AND CLEANING



219

STAINS



253

SPECIAL STAINS CONTROL SLIDES



277

LABELS, MARKERS AND PENCILS



287

IMMUNOHISTOCHEMISTRY

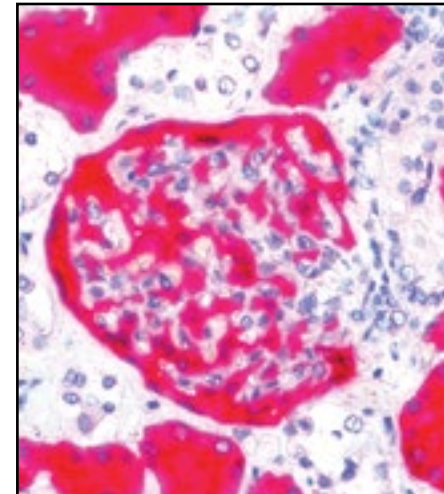

329

CYTOLOGY



347

EQUIPMENT



365

INDEX

Description	Page	Description
3-Stamp Dip (Quick) Kit	236	Biopsy paper, tri-fold™, folding biopsy paper
4 slide jar, pre-filled with 95% ethyl	340	Biopsy Punches, dermatology disposable, bevel®
Acetone	90	Blade, dermatology, bevel®
Acid Alcohol FS	234	Dermal Curette
Air monitor/Vapor Badges™	212	Blade, dermatology, Mitex®
Alcohol	93-96	Blade, Mitex® Punched
Aldehyde neutralizer, Formalin® Green liquid	95-96	Blade, double edge blade
Aldehyde neutralizer, N-15™ powder	213-214	Blade, single edge blade
Aldehyde spill control granules, Polyform-F	215	Blotter™ scalpel exchange device
Ammonium hydroxide	239	Block softener, Soft-Cut™
Antibodies	286-305	Blung, H&E
		Bovine's fixative
		Brushes, paraffin and frozen section

GROSSING SPECIMEN PROCESSING



CONSUMABLES FOR EFFICIENT BIOPSY PROCESSING

CDI's Tissue Marking Dyes® • Blades • Handles
Instruments & Accessories • Grossing Pads • Biopsy Security



CDI's Tissue Marking Dyes®

- Define margins without bleeding, changing color or fading
- Optimal viscosity for easier application

CDI's Tissue Marking Dyes®

Our complete range of Tissue Marking Dyes provide greater application choice.



Multi-use squeezers	MD1000 Series	A
Applicator series (FOAM TIP)	0726 Series	B
Flip-top mini bottle (.5 oz 14.7mL)	0723 Series	C
Dropper Tip, squeeze bottle (.5 oz 14.7mL)	0724 Series	D
Dropper tip, squeeze bottle (2 oz 59.1mL)	0725 Series	E
Bottle (2 oz 59.1mL Flip-Top)	0727 Series	F
Bottle (8 oz 236.5mL Flip-Top)	0728 Series	G
Disposable dye kit	MK Series	H
SterileMargin	SMD Series	I

CDI's Ink Aid™
 CDI's Tissue Marking Dyes are formulated to be used without a mordant, however Ink Aid™ may aid in adherence particularly to fatty tissue. Acetic Acid solution designed to be used with CDI's Tissue Dye formula.
IA4004 4oz CS/8
IA4000 8oz CS/5

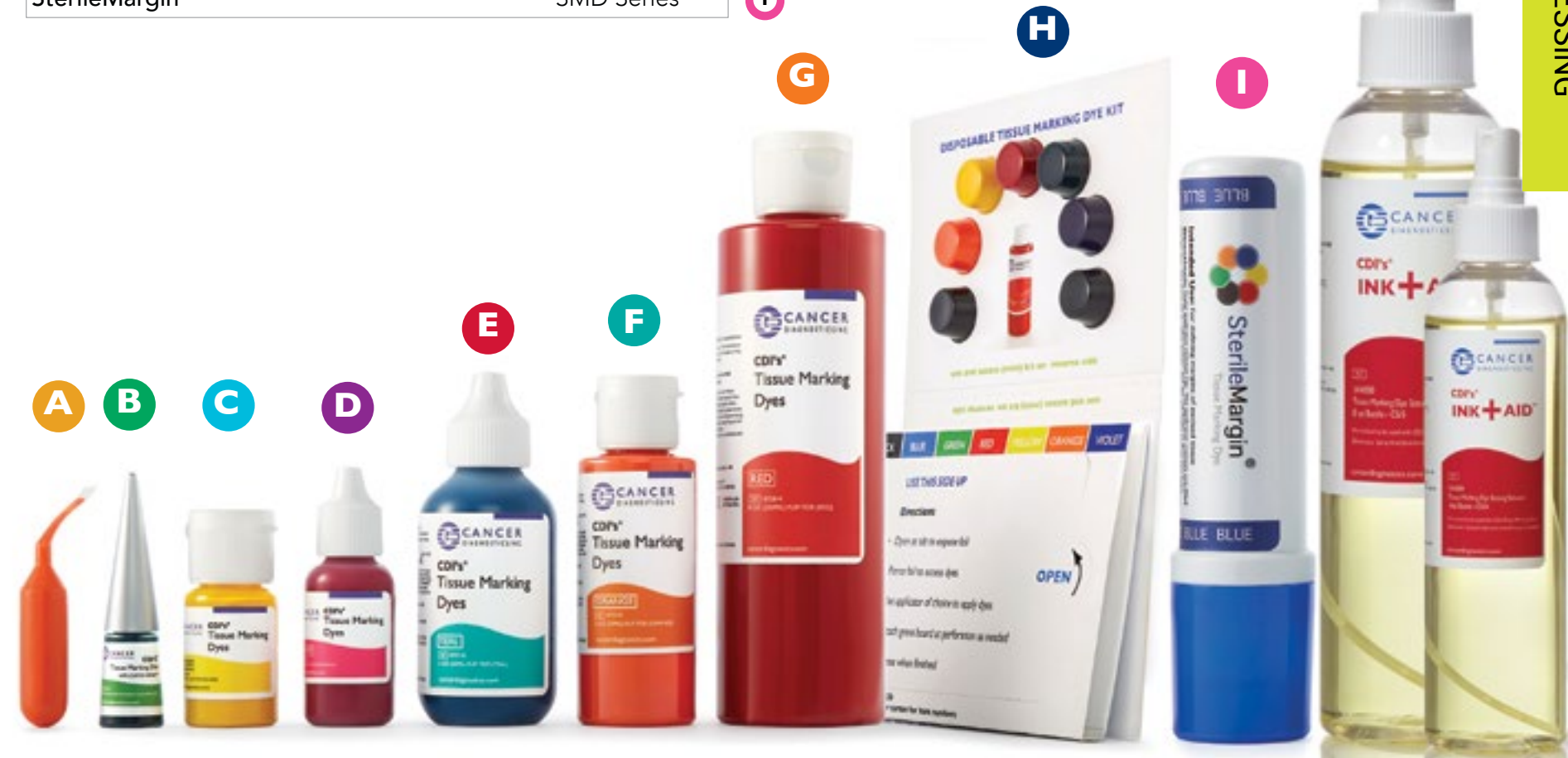

The Original 7 Dye Color Kit

The Original 7 Dye Color Kit (2 oz) for defining tissue margins. Consistency, durability, and brightness under the microscope provide diagnosing assurance. A variety of packaging options provide greater application options and efficiency. Wood, Plastic, Acrylic trays kits available.

- ● ● ● ● 5 Dye Kit: Black, Blue, Green, Red, Yellow
- ● ● ● ● ● 6 Dye Kit: Black, Blue, Green, Red, Yellow, Orange
- ● ● ● ● ● ● 7 Dye Kit: Black, Blue, Green, Red, Yellow, Orange, Violet

5

6

GROSSING SPECIMEN PROCESSING

THE ORIGINAL



Wood Tray

Plastic Tray

Item	Description	Qty
01000	5 Dye Kit (2 oz) with Wood Tray and 50 applicator sticks	EA.
02000	6 Dye Kit (2 oz) with Wood Tray and 50 applicator sticks	EA.
03000	7 Dye Kit (2 oz) with Wood Tray and 50 applicator sticks	EA.
00003	Wood Tray Only	EA.

Item	Description	Qty
01000P	5 Dye Kit (2 oz) with Plastic Tray and 50 applicator sticks	EA.
02000P	6 Dye Kit (2 oz) with Plastic Tray and 50 applicator sticks	EA.
03000P	7 Dye Kit (2 oz) with Plastic Tray and 50 applicator sticks	EA.
00003	Plastic Tray Only	EA.



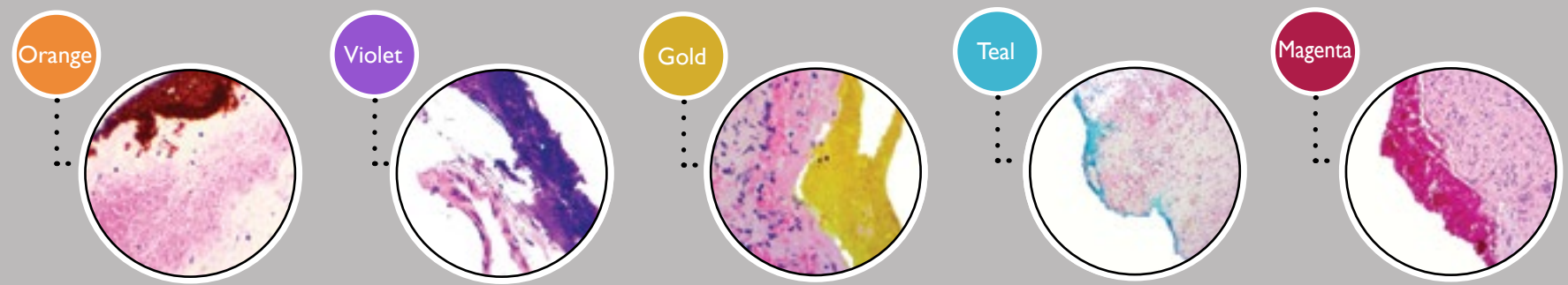
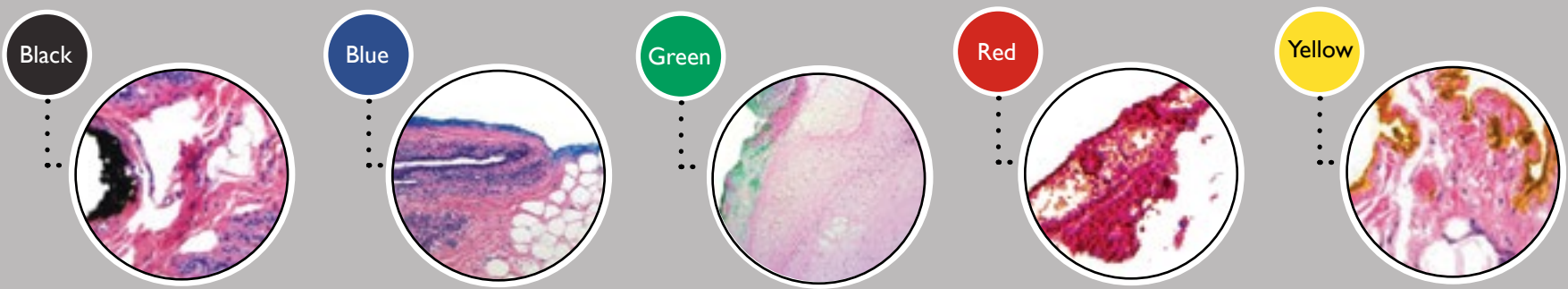

Pointed Cotton Tip

Swab Cotton Tip

7 Dye Kit



Pointed Cotton Tip

Swab Cotton Tip

10 Dye Kit



Acrylic Tray

Item	Description	Qty
03000A	7 Dye Kit (2 oz) with Acrylic Tray and 100 applicator sticks (50 pointed tip, 50 swab tip)	EA.
00003A	Acrylic Tray Only	EA.



Acrylic Tray

Item	Description	Qty
03010A	10 Dye Kit (2 oz) with Acrylic Tray and 100 applicator sticks (50 pointed tip, 50 swab tip)	EA.
00103A	Acrylic Tray Only	EA.



CDI's 7 Dye Tissue Marking Dye Kits[®] (.5 oz) Bottles

CDI's Tissue Marking Dyes[®] Dropper Tip, Squeeze Bottle



Item	Description	Qty
06000	7 Dye Kit (.5 oz) Bottles with Plastic Tray and 50 applicator sticks	EA.
00006	Plastic Tray	EA.



2 OZ Bottles

Item	Description	Qty
• 0725-1	Black	EA.
• 0725-2	Blue	EA.
• 0725-3	Green	EA.
• 0725-4	Red	EA.
• 0725-5	Yellow	EA.
• 0725-6	Orange	EA.
• 0725-7	Violet	EA.
• 0725-8	Gold	EA.
• 0725-9	Teal	EA.
• 0725-10	Magenta	EA.
51117	Set of 7 colors (No Tray)	Set of (7)
51110	Set of 10 colors (No Tray)	Set of (10)

.5 OZ Bottles

Item	Description	Qty
• 0724-1	Black	EA.
• 0724-2	Blue	EA.
• 0724-3	Green	EA.
• 0724-4	Red	EA.
• 0724-5	Yellow	EA.
• 0724-6	Orange	EA.
• 0724-7	Violet	EA.
• 0724-8	Gold	EA.
• 0724-9	Teal	EA.
• 0724-10	Magenta	EA.
06001	7 Dye Kit (.5 oz) with Plastic Tray and 50 applicator sticks	EA.

Soft easy-squeeze bottle with dropper tip
Facilitates easy dye application



CDI's Tissue Marking Dyes,[®] Flip-Top Individual Bottles

Tissue Marking Dyes for marking margins & multiple biopsies. Dyes have been developed to define margins without bleeding, changing color or fading. Comes with flip top dispenser cap. Available in kits as well (see pages 5-9).

8 OZ Bottles

Item	Description	Qty
• 0728-1	Black	EA.
• 0728-2	Blue	EA.
• 0728-3	Green	EA.
• 0728-4	Red	EA.
• 0728-5	Yellow	EA.
• 0728-6	Orange	EA.
• 0728-7	Violet	EA.
• 0728-8	Gold	EA.
• 0728-9	Teal	EA.
• 0728-10	Magenta	EA.
81116	Set of (6) 8oz Bottles	Set of (6)
81117	Set of (7) 8oz Bottles	Set of (7)
81110	Set of (10) 8oz Bottles	Set of (10)

2 OZ Bottles

Item	Description	Qty
• 0727-1	Black	EA.
• 0727-2	Blue	EA.
• 0727-3	Green	EA.
• 0727-4	Red	EA.
• 0727-5	Yellow	EA.
• 0727-6	Orange	EA.
• 0727-7	Violet	EA.
• 0727-8	Gold	EA.
• 0727-9	Teal	EA.
• 0727-10	Magenta	EA.
21115	Set of (5) 2oz Bottles	Set of (5)
21116	Set of (6) 2oz Bottles	Set of (6)
21117	Set of (7) 2oz Bottles	Set of (7)
21110	Set of (10) 2oz Bottles	Set of (10)
00003	Wood Tray Only	EA.
P0003	Plastic Tray Only	EA.

.5 OZ Flip-Top Mini Bottles

Item	Description	Qty
• 0723-1	Black	EA.
• 0723-2	Blue	EA.
• 0723-3	Green	EA.
• 0723-4	Red	EA.
• 0723-5	Yellow	EA.
• 0723-6	Orange	EA.
• 0723-7	Violet	EA.
• 0723-8	Gold	EA.
• 0723-9	Teal	EA.
• 0723-10	Magenta	EA.



DEFINE MARGINS WITHOUT BLEEDING OR FADING



Multi-Use Squeezers

4 ml pre-filled dispenser "Squeezers" with caps for recapping unused portion. Available in 6 and 7 color kit form, and one-color dispenser boxes of 15. Air-tight packaging keeps dyes from thickening.



Pack of 15

Features

- Optimal dye consistency
- Bright Dyes hold permanently through processing and staining
- Easy Application
- Packaging limits exposure to air

Item	Description	Qty
• MD1001	Black	PK/15
• MD1002	Blue	PK/15
• MD1003	Green	PK/15
• MD1004	Red	PK/15
• MD1005	Yellow	PK/15
• MD1006	Orange	PK/15
• MD1007	Violet	PK/15
MD2000	6 Color Kit (3 of each color w/holding tray)	PK/18
MD3000	7 Color Kit (3 of each color w/holding tray)	PK/21

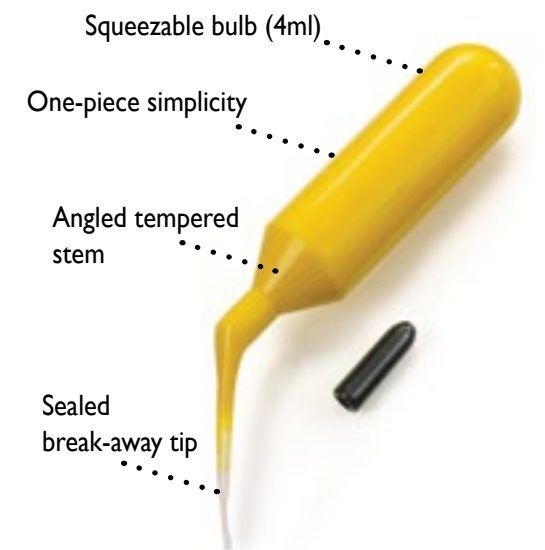

TIP
Dye can be squeezed directly onto larger tissues, and 'blotted' but it is recommended to be squeezed into receptacle and used with applicator stick for more precise application.



CDI's Tissue Marking Dyes,[®] Applicator Series[™]

Fine Tip Applicator designed for small biopsies where precise application is required. Available .10 fl. Oz (3 mL), in 10 colors.

Item	Description	Qty	Item	Description	Qty
• 0726-1	Black	EA.	• 0726-8	Gold	EA.
• 0726-2	Blue	EA.	• 0726-9	Teal	EA.
• 0726-3	Green	EA.	• 0726-10	Magenta	EA.
• 0726-4	Red	EA.	04000	Set of 7 colors with plastic tray	EA.
• 0726-5	Yellow	EA.	04300	Set of 3 colors with plastic tray	EA.
• 0726-6	Orange	EA.			
• 0726-7	Violet	EA.			

(Actual Sizes Below)

Color substitution requests can be specified at the time of order



04000 Set of 7 colors and tray

Black, Blue, Green, Red, Yellow, Orange and Violet

04300 Set of 3 colors and tray

Gold, Teal and Magenta
(Or Specify Custom Colors)

CDI's Tissue Marking Dye® Trays

2 oz bottles



Acrylic Two Tier Tray - 2 oz Tissue Marking Dye (7 colors)

Item	Description	Qty
00003A	Acrylic Two Tier Tray	EA.

2 oz bottles



Acrylic Two Tier Tray - 2 oz Tissue Marking Dye (10 colors)

Item	Description	Qty
00103A	Acrylic Two Tier Tray	EA.

.10 oz Applicators



Plastic Tray - Applicator Series Tissue Marking Dye (7 and 3 colors)

Item	Description	Qty
04000T	Plastic Tray (7)	EA.
04300T	Plastic Tray (3)	EA.



.5 oz bottles



Plastic Tray - .5 oz Flip Top Tissue Marking Dyes (7 colors)

Item	Description	Qty
00006	Plastic Tray	EA.

2 oz bottles



Plastic Tray - 2 oz Tissue Marking Dyes (7 colors)

Item	Description	Qty
P0003	Plastic Tray	EA.

2 oz bottles



Wood Tray - 2 oz Tissue Marking Dyes (7 colors)

Item	Description	Qty
00003	Wood Tray	EA.



SterileMargin®

SterileMargin® is a sterile tissue marking dye. It can be used anywhere sterile dye is needed for marking excised tissue. It allows the surgeon to define margins immediately following surgery. SterileMargin® is a sterile kit that is packaged per color.

Kit includes: Broad applicator; precise applicator; priming card (for large applicator), margin key/ reference labels.



MarginMap® Orientation Charms

The charms are easily sutured to their corresponding margin to identify orientation.

Item	Description	Qty
304R	Margin Map® 5mm charms	CS/24
308R	Margin Map® 10mm charms	CS/24



Item	Description	Qty
• SMD1	Black Applicator	EA.
• SMD2	Blue Applicator	EA.
• SMD3	Green Applicator	EA.
• SMD4	Red Applicator	EA.
• SMD5	Yellow Applicator	EA.
• SMD6	Orange Applicator	EA.



Disposable Dye Kits



- Features**
- Foil Sealed Disposable Tissue Marking Dye Kit.
 - 7 colors. Pierce Foil with applicator stick and apply dyes as needed. Detach Bio Board (mini) to use as work surface.
 - Dispose when finished.
 - Designed for the MOHS Lab but also used at point of surgery and grossing room.
 - Reduce inventory on dye bottles and have fresh dye available for margin marking on demand.

Item	Description	Qty
MK0030	Disposable Dye Kits	BX/25
MK0120	Disposable Dye Kits	CS/100



Pierce foil to access dyes



Apply dyes as needed, use cotton tipped or stick side



Wood Applicator Sticks

Item	Description	Qty
CT1111	Cotton Tipped one end	CS/1000
CT1112	Cotton Tipped one end	PK/100
CTP1111	Cotton Tipped Pointed one end	CS/1000
CTP1112	Cotton Tipped Pointed one end	PK/100
BI112	Barrel shaped stick/no point/no cotton	PK/100
BI112-CS	Barrel shaped stick/no point/no cotton	CS/1000
PT112	Pointed Stick one end	PK/100

Foam Tip Applicators, 5" & 6"

Item	Description	Qty
FTA200	6" (152.4mm), 7.1mm wide head*	PK/50
FTA300	5" (127mm), 21mm diameter head*	PK/50



* will fit inside standard dye bottle opening



Winged Applicator Sponge

Unique 3.5" x 3.5" Tissue Dye applicator sponge with die cut winged handles, for efficient and uniform coverage of larger specimens.

Item	Qty
WA3535	PK/25



Blue Sponge Applicator, 6"

Disposable 1.5" x 1.5" sponge applicator on polyethylene handle for marking specimens.

Item	Description	Qty
FTA400	Blue Sponge Applicator	PK/25



Fine Tip Applicator

Fine tip 3.5" applicator for delicate marking of specimens.

Fits CDI's Applicator Series™ bottle for single-use. See pages 15-16

Item	Description	Qty
FTA100	Fine Tip Applicator	PK/100





SBC Blue™
 SBC Blue™, Small Biopsy Colorant Dropper style bottle; Easy application for better visualization of small biopsies.

Item	Description	Qty
SBC001	1 oz Dropper/Squeeze Bottle	EA.

Breast Cores

Insight LLD™ Specimen Board

A device that allows for accurate localization of suspect lesions in breast tissue (on radio-opaque grid). Grossing can also be performed directly on board.

- PATHOLOGIST BENEFITS**
- Allows grossing to be done directly on board
 - Features a non-stick upper panel
 - Absorbent lower panel prevents shifting of specimen during transport
- RADIOLOGIST BENEFITS**
- Allows localization on radio-opaque grid
 - Helps prevent second operation and loss of normal tissue up to three films from a single exposure due its compact size
 - Enables compression mammography using Velcro® fasteners to secure flexible hinged panels
- SURGEON BENEFITS**
- Permits more rapid and accurate excision of specimen which indicates location of additional tissue to be removed if lesion is not found in original specimen

Item	Description	Qty
LLD16600	Board	BX/10

Size
 7 ½" (Wide) x 7.7/8" (Deep)



X-Ray Image

Using Specboard™?
 Try
 Insight LLD™



bevel® Blades

bevel® scalpel blades are available as either Carbon steel or Stainless steel (sterile) singly packed in peel open foil pouches with a VCI protective inner liner.

The highest quality strengthened raw material steel combined with proprietary grinding and finishing techniques provides consistent sharpness and durability that results in superior cutting. Handle fitment #4

Item	Description	Qty
BB0022	bevel ® Carbon Steel Scalpel Blade, Sterile #22	CS/100
BBS022	bevel ® Stainless Steel Scalpel Blade, Sterile #22	CS/100
BB0060	bevel ® Carbon Steel Scalpel Blade, Sterile #60	CS/100
BBS060	bevel ® Stainless Steel Scalpel Blade, Sterile #60	CS/100



Scalpel Blades, Swann Morton®

Individually wrapped in boxes of 100.

Item	Description	Qty
IB0022	#22 Regular (pointed) Tip	CS/100
IB0022-B	#22 Blunt Tip	CS/100
IB0060	#60 Regular (pointed) Tip	CS/100
IB0060-B	#60 Blunt Tip	CS/100



England



England



Cincinnati Surgical Blades

Individually wrapped in boxes of 100.

Item	Description	Qty
0222-CS	#22 Blade	CS/100
0260-CS	#60 Blade	CS/100
IB0070	#70 Blade	CS/100



Japan



Scalpel Blades, Feather® Brand

Individually wrapped in boxes of 100.

Item	Description	Qty
IB0010-F	#10 Feather® Brand	CS/100
IB0011-F	#11 Feather® Brand	CS/100
IB0015-F	#15 Feather® Brand	CS/100
IB0022-F	#22 Feather® Brand	CS/100

USA



Carbon Steel Scalpel Blades and Handles

Carbon steel Bard-Parker® Rib-Back™ blades. Non-Sterile and individually wrapped.

Bard-Parker® blade handles: contoured poly handle and metal handle. Made in USA

Item	Desc.	Qty
BP22	#22 Blade	CS/150 (25 strips of 6/CS)
BP60	#60 Blade	CS/150 (25 strips of 6/CS)
BP4	#4 Handle	EA.
BP6	#6 Handle	EA.
BP8	#8 Handle	EA.
BP4-CS	#4 Handle	CS/5
BP6-CS	#6 Handle	CS/5
BP8-CS	#8 Handle	CS/5

**BP4 and BP6 fit #22 blade
BP8 fits #60 blade**



SAFHandle™ Safety Scalpel

Reduce your worry around sharp objects and safety with the SafHandle™ Safety scalpel handle. The handle is specifically designed to easily attach, remove and dispose of a blade without the need of force. This decreases the risk of cutting yourself. The innovative design ensures that the blade can withstand the pressure of cutting hard tissue without popping off during use.

Item	Description	Qty
SAFH-4EA	#4 Safety handle	EA.
SAFH-4	#4 Safety handle	PK/6

Reusable Safety Scalpel

Matches the feel of conventional scalpels. No change in technique. 'No-touch' blade removal.

Fitment: SAFhandle™ reusable metal handles conform to ISO 7740:1985/EN 27740:1992 fitment standard are compatible with all standard scalpel blades with the exception of blades with reinforced- back.

Materials: Surgical grade stainless steel made in Germany conforming to EN 10088-3:2005.

Sterilization: Non Sterile.

SAFHandle™



A Safety scalpel handle



B Easily Open



C Insert Scalpel Blade and Close

Blades and Handles

Double Edge Pathology Blade and Handle

Use blade with the Pathco handle or similar for double edge grossing. Individually wrapped. Double edge blade handle locks into place with simple twist of the handle.

Item	Description	Qty
DEB100-C	Blade (Individually wrapped)	BX/100
DEB00H	Double Edge Blade Handle	EA.



Double Edge Disposable Blade and Handle

Handle and Blade. Dispose when dull.

Item	Description	Qty
DEB-BX10	Disposable double edge blade and handle	BX/10



Single Edge Blade (Long)

Stainless steel with aluminum backing. 2.258" x 0.525" x 0.009"

Item	Description	Qty
SEB250	Single Edge Blade	BX/250



GEM® by Personna Single Edge Blade Safety Dispenser

Aluminum back safety dispenser. Also available in bulk.

Item	Description	Qty
SD-0325	Safety Dispenser	EA.
SD-0325-BULK	Safety Dispenser	CS/50



Personna Regular Duty Single Edge Blade (Short)

Stainless steel with aluminum back. Packaged non-dispenser.

Item	Description	Qty
SEB100	Single Edge Blade	PK/100

Color Handles Solid and Comfortable

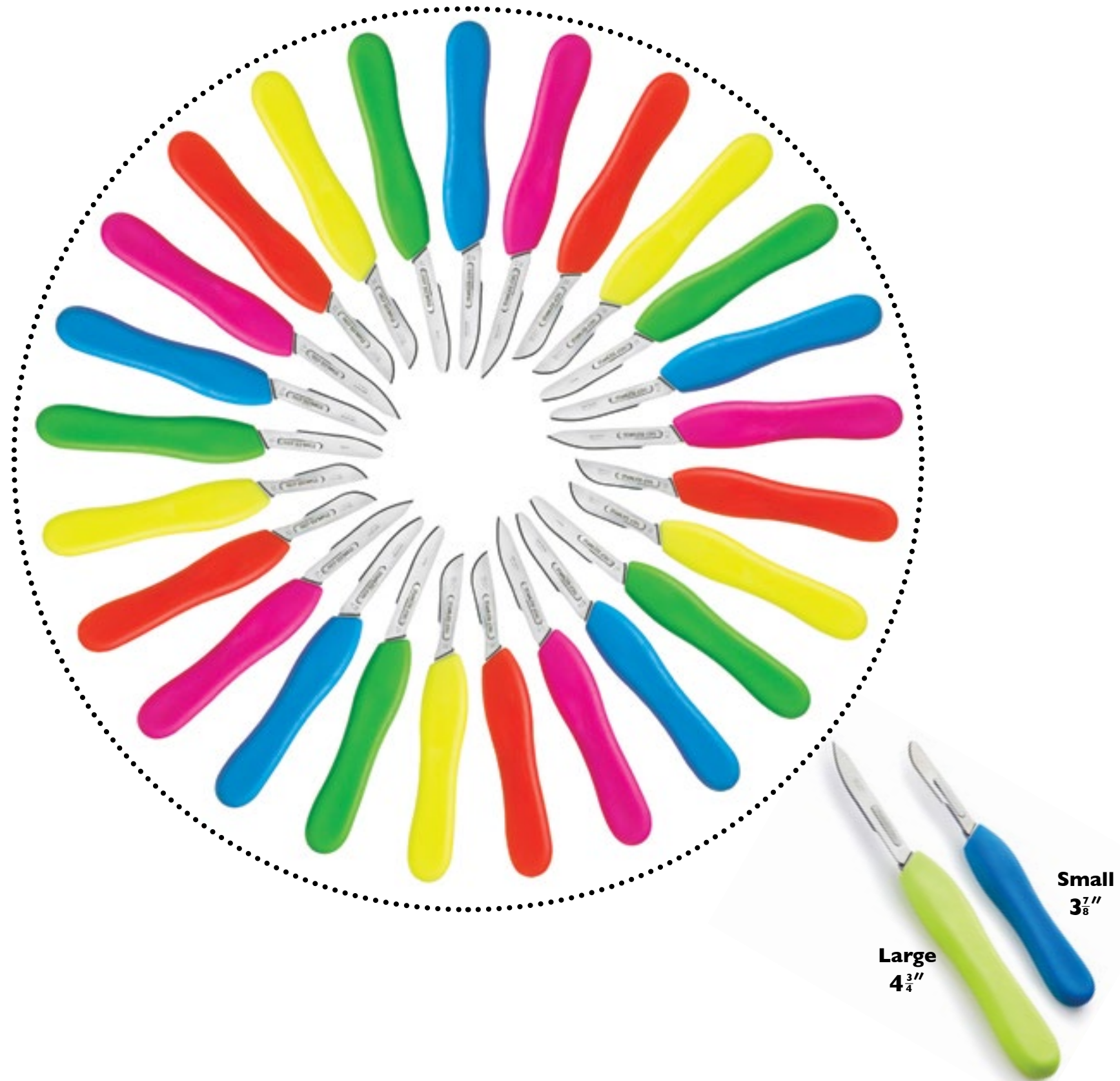

Plastic/ Ergonomic Scalpel Handle, Universal Stainless Tip* for #22, #60, and #70 scalpels. Handle available in two sizes, small and large

This unique handle will fit all three sizes (#22, #60, & #70) of scalpel blades common to Anatomic Pathology. Ergonomic handle has comfortable feel and different colors allow for color coding in the gross room, or simply user preference.

Standard colors are Blue, Orange, Pink, Yellow and Green. Handles are sold individually or available in Multi-Color Pack. (one of each color)

Item Small Handle	Item Large Handle	Description	Qty
SHY001	SHY000	Yellow	EA.
SHP001	SHP000	Pink	EA.
SHO001	SHO000	Orange	EA.
SHG001	SHG000	Green	EA.
SHB001	SHB000	Blue	EA.
SHM444	SHM555	Multi-Color (Orange, Green, Pink, Blue & Yellow)	PK/5

*Add "-22" to item number for specific blade fitment to size #22. Handles are manufactured to ISO 7740:1985 #4 standard for #20-24 blades for this version.

Metal Blade Handles

Sold individually.

Item	Description	Qty
A SLH6070-CS	Flat Stainless Steel Handle #4 for #60 & #70 Blades	EA.
B SH6070-CS	Ergonomic Stainless Steel Handle Size 8-0 for #60 & #70 Blades	EA.
C SH0022-CS	Stainless steel Ergonomic Blade Handle for blades 20-26	EA.
D SH6070-SM	Metal Blade Handle Fits Blades #60 & #70 Swann Morton	EA.
E SH022-SM	Swann Morton Handle #6 For Blades 20-26	EA.





#22 #60 #70 (blunt)

Stealth™ Safety Scalpels

Integrated rigid plastic handle with protective sheath. Slide sheath down to use, slide up when not in use. Dispose when dull.

Item	Description	Qty
SL0022	Scalpel #22	CS/100
SL0060	Scalpel #60	CS/100
SL0070	Scalpel #70	CS/100

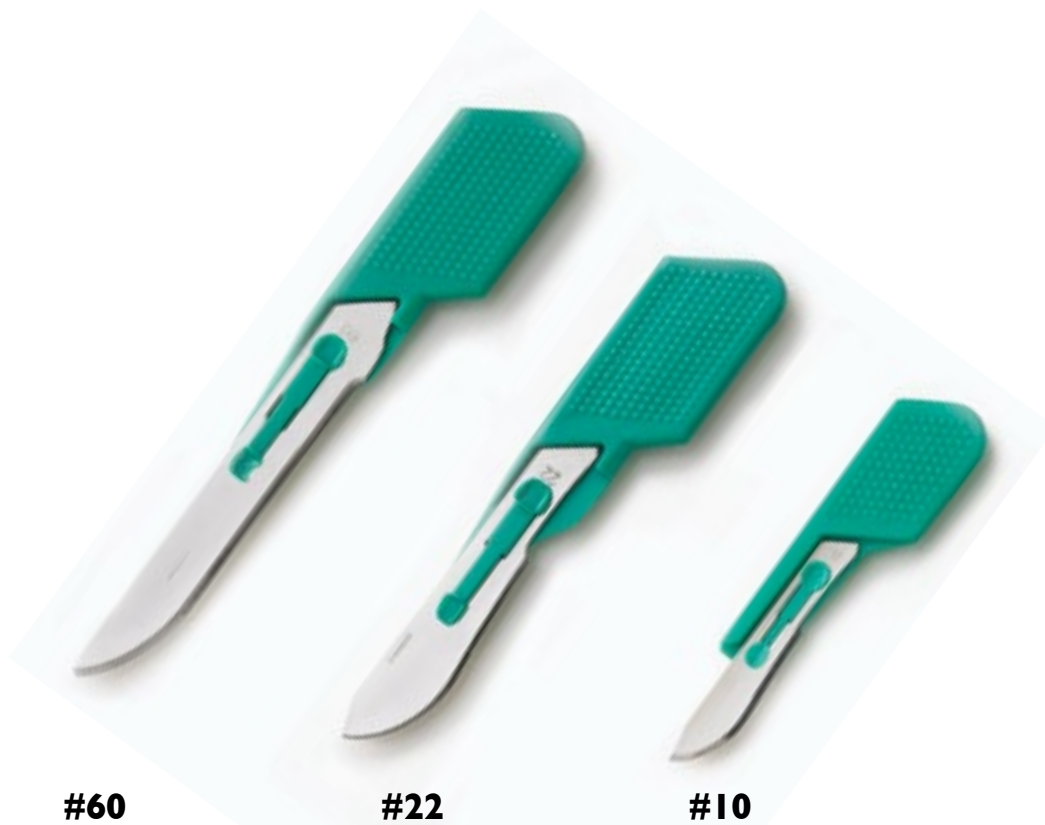

#60 #22 #10

Finger Scalpels™

Scalpel blade attached to small slip resistant handle. Ultimate in dexterity and convenience.

Sizes: #10, #22, and #60. Available sterile and non-sterile.

Non- Sterile

Item	Description	Qty
FS2222	#10	CS/100
FS0022	#22	CS/100
FS0060	#60	CS/100

Sterile

Item	Description	Qty
FS2222-S	#10	CS/50
FS0022-S	#22	CS/50
FS0060-S	#60	CS/50



Scalpels Retractable

Gamma sterilized and packaged in individual pouches. Sheffield stainless steel blade retracts with one simple motion and can be permanently locked inside the handle for safe disposal.

Item	Description	Qty
SR0010	Scalpel #10	BX/10
SR0011	Scalpel #11	BX/10
SR0015	Scalpel #15	BX/10



Plastic scalpel handles

Gamma sterilized and individually foil packaged. Finely honed Sheffield stainless blade for exacting performance.

Item	Description	Qty
PSH0010	Scalpel #10	BX/10
PSH0011	Scalpel #11	BX/10
PSH0015	Scalpel #15	BX/10
PSH0022	Scalpel #22	BX/10

Bladex



SAFELY EXCHANGE USED BLADES IN ONLY SECONDS

Bladex Scalpel Exchanging Device

The Bladex Scalpel Exchanging System allows the user to exchange scalpel blades (#22 or #60) without touching the blades. Simply place Bladex handle into unit and turn to remove blade. Push handle into unit and turn again to attach blade from scalpel blade cartridge. Used scalpels drop into contained sharps container, and disposable device is discarded when full.

Item	Description
HNDL3-2260	Bladex Metal Scalpel Handle
BLX60	#60 Cartridge for Bladex Device (50 blades)
BLX22	#22 Cartridge for Bladex Device (75 blades)
BLDX3-60SK	Bladex Scalpel Changing System (One Unit with enclosed sharps container, Scalpel Handle and one #60 Cartridge) Shown Right
BLDX3-22SK	Bladex Changing System (One Unit with enclosed sharps container, Scalpel Handle and one #22 Cartridge) Shown Right
BLDX2260-DS	Bladex Scalpel Changing System (One Unit with enclosed sharps container). User will need handle and scalpel cartridges #22 or #60.



Sharps Container

A secure and effective method of disposal for your contaminated sharps. View the fill level easily through the translucent base. Puncture resistant container is autoclave-and-incinerator safe. Stackable.

Item	Description	Vol
SC-1.0QT	Disposable Sharps Container	1.0qt
SC-8QT	Disposable Sharps Container (Dome Top-Pictured)	8qt (2 gallon)
SC-2GAL	Disposable Sharps Container (Flat Top)	8qt (2 gallon)



The Quicksmart® Blade Remover

Single-handed removal and immediate containment of contaminated scalpel blades.

Item	Description	Qty
48QS	Blade remover	EA.

Dispenser Version

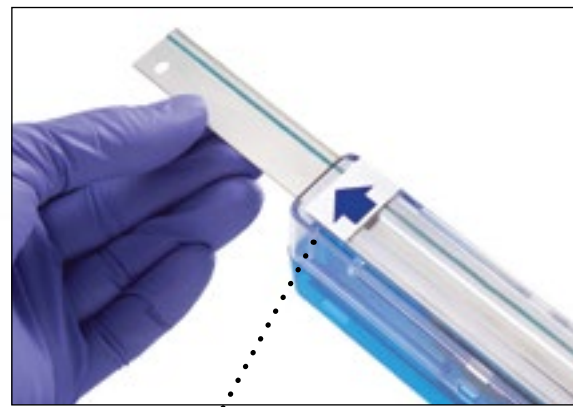

Convenient dispensing for easier handling

Ergonomic Design



bevel® Trimming Knives, bevel® and Feather® Trimming Blade Handles

Stainless Steel Blades 260 mm and 130 mm. These blades are inserted into the Trimming Blade Handle for precise, sharp, trimming and grossing.

Item	Description	Qty
TKH00S	Feather® Trimming Blade Handle Short	EA.
TKH00L	Feather® Trimming Blade Handle Long	EA.
TBH00S	bevel® Trimming Blade Handle Short	EA.
TBH00L	bevel® Trimming Blade Handle Long	EA.
BTK0130	bevel® Trimming Knives (Short) Dispenser	PK/50
BTK0260	bevel® Trimming Knives (Long) Dispenser	PK/50
BTK0130X	bevel® Trimming Knives (Short) non-dispenser (wrapped)	PK/50
BTK0260X	bevel® Trimming Knives (Long) non-dispenser (wrapped)	PK/50

- A TKH00S
- B TKH00L
- C TBH00L
- D TBH00S
- E BTK0130X
- F BTK0260X
- G BTK0130
- H BTK0260



Non-Dispenser Version



Original Packaging Shown

Blade Attacher

Item	Description	Qty
KH0130	Blade Holder 130mm Blades	EA.
KH0260	Blade Holder 260mm Blades	EA.



Blade Attacher

Place blade into holder sharp side down for safe, easy attaching

Macro Prep Knives

Disposable long lasting Sheffield stainless steel blades. Integrated handle.

Item	Description	Qty
K1004	4" Knife	PK/10
K1006	6" Knife	PK/10
K1008	8" Knife	PK/10
K1010	10" Knife	PK/10
K1012	12" Knife	PK/10
K1014	Assorted Sizes	PK/10 (2 of each size)



All-in-one disposable blade and handle



Blade Remover

Convenient method for removal of #22 scalpel blades. Insert blade and handle into the slot, press and pull. Blade falls safely into a compartment that stores up to 100 blades. Sold individually.

Item	Description	Qty
SBR001	#22 scalpel blade remover	EA.

Bevel® Microtome Blade Handles

Bevel® Micro, Microtome handle, reusable. Designed for CDI's High or Low bevel series microtome blades for grossing specimens.

Item	Description	Qty
LHPJ00H	Bevel® Microtome Blade Handle	EA.



Fusion Micro: Fusion Single Use Handles

Turn your low profile microtome blades into a grossing knife. Simply place blade in slot and secure with attached "nib". Pack of 50.

RECOMMENDED:

Blade can be attached effortlessly and safely (without being exposed to sharp side) by using molded "Easy attaching template" ITEM# FUS888 Great for cutting eyes, and grossing to desired thicknesses.

Item	Description	Qty
FUS000	Fusion (MICRO) Handles	PK/50
FUS888	Easy Attacher (Safely attaches blade)	EA.
FUS999	Combo Pack (50 handles/50 blades)	PK/50
LPJ3580	Microtome Blades	BX/50

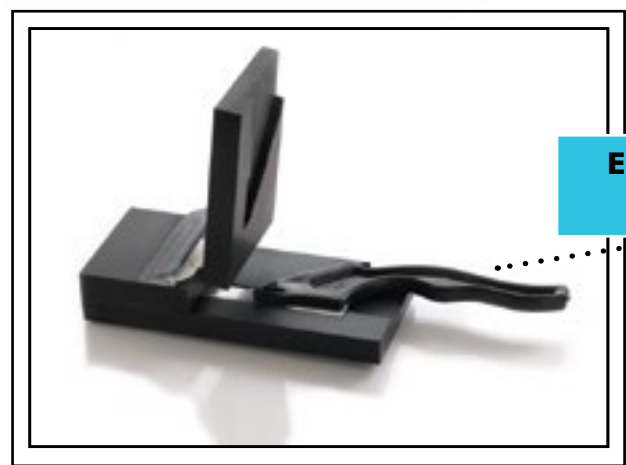

Easy Attacher Step 1



Easy Attacher Step 2

Fusion Ultra Knife

For trimming and sectioning tissue samples during surgical grossing and autopsy procedures. Specially designed handles and "razor thin" blades provide an extremely sharp knife for a wide variety of sectioning requirements. All-in-one stainless steel blade and plastic handle design with integrated blade guard that removes easily prior to use.

- Pull off Protective Sheath
- Dispose when dull
- 6 in. blade (15.24 cm) stainless steel

Item	Description	Qty
ULT702	Fusion Ultra Knife	BX/5

Excellent for Cutting Sections to Desired Thickness Horizontally



Super Scalpel PM Blade

REDESIGNED NEW STYLE Super Scalpel with integrated black plastic handle. No need to manually change blade - dispose whole knife when dull.

Designed for Autopsies and large specimens. Ergonomic handle with "Thumb-Notch" for leverage and comfort.

Item	Description	Qty
SS0120	Super Scalpel Blade PM40 (integrated handle and blade)	PK/20
PM40	PM40 Blade Only	BX/10
PM40-HNDL	PM40 Stainless Handle	EA.



Dissection Knife 7 inch blade

Extra sharp, hollow ground high carbon stainless steel blade cast permanently to an all aluminum handle.

Item	Description	Qty
GK0007	Dissection Knife	PK/5





bevel® Dermal Curettes

Disposable bevel® Dermal Curettes are used for scraping skin lesions and growths. A variety of tip sizes are available to accommodate varying lesion sizes 2.0,3.0,4.0,5.0,7.0 mm

- Seamless stainless steel sharp cutting edge
- Easy dynamic gripping handle
- Disposable, Sterile and ready to use
- Wide range of sizes

Item	Description	Qty
DC1020	2.0 mm	BX/10
DC1030	3.0 mm	BX/10
DC1040	4.0 mm	BX/10
DC1050	5.0 mm	BX/10
DC1070	7.0 mm	BX/10
DC5020	2.0 mm	CS/500 (Bulk)
DC5030	3.0 mm	CS/500 (Bulk)
DC5040	4.0 mm	CS/500 (Bulk)
DC5050	5.0 mm	CS/500 (Bulk)
DC5070	7.0 mm	CS/500 (Bulk)

bevel® Biopsy Punch

Disposable bevel® Biopsy Punches are used to cut and remove circular pieces of tissue (skin) for further examination. The sharp blade and ribbed handle ensure safe, clean and easy sample extraction.

- Seamless stainless steel sharp cutting edge
- Ribbed handle for sure grip & control
- Size embossed on each punch for easy identification
- Disposable, Sterile and ready to use
- Wide range of size



Quantity	1.0 mm	1.5 mm	2.0 mm	2.5 mm	3.0 mm	3.5 mm	4.0 mm	5.0 mm	6.0 mm	7.0 mm	8.0 mm
BX/10	BP1010	BP1015	BP1020	BP1025	BP1030	BP1035	BP1040	BP1050	BP1060	BP1070	BP1080
CS/500 Bulk	BP5010	BP5015	BP5020	BP5025	BP5030	BP5035	BP5040	BP5050	BP5060	BP5070	BP5080

Miltex® BioBlade

- Sterile
- Used for skin/tissue saucerization and shave biopsy
- Flexible design allows the blade to be positioned at various angles
- Individually packaged

Item	Description	Qty
33-100	BioBlade	BX/50



Miltex® Punches

- Sterile
- Short handle is useful to biopsy hard-to-reach areas

Item	Description	Qty
33-33-SH	3.5 mm	BX/50
33-34-SH	4.0 mm	BX/50
33-35-SH	5.0 mm	BX/50
33-36-SH	6.0 mm	BX/50

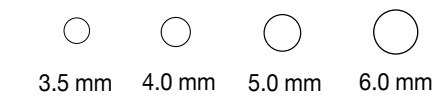



Wide Tip for Biopsy Transfer

Find Micro Pipette on page 251

Plastic Disposable Pipettes

A Disposable graduated low density polyethylene transfer pipette

Item	Vol.	Qty
PT1000	3 mL (7 mL Bulb) Non-Sterile	CS/500
PT1000-ST	3 mL (7 mL Bulb) Sterile	CS/500

B Grossing pipette, disposable large aperture plastic transfer pipette

For easy removal of small specimens when transferring from fixative containers to cassettes. Protects and maintains integrity of delicate specimens where forcep removal may compromise tissue.

Item	Vol.	Qty
PT1000-CUT	3 mL (9 mL Bulb)	CS/500

CellSafe, Biopsy Cassette Insert

The CellSafe Biopsy Capsule offers high specimen security. It is an easy-to-use alternative to the more traditional and time-consuming handling techniques such as tissue wrap and foam pads. The extra fine X-Ray transparent mesh also offers zero tissue damage and low reagent carry over.

Measurements: Overall: 28 mm x 25 mm x 5 mm high.

Item	Description	Qty
CW7777	White	PK/100
CB7777	Blue	PK/100

Firmer mesh is more robust providing added security.

New catch feature gives a positive 'click' sound and feel when closed, giving the user notification that the capsule is truly shut.

Easy Twist

Mesh Biopsy Bags, AutoSette™ Series

- ▶ New material makes it effortless to twist open bag between thumb and forefinger.
- ▶ A folded bottom and gentle seams make for easy opening during embedding greatly reducing the "springboard effect" associated with other bags.
- ▶ The material allows for complete infiltration and optimal flow while providing the highest in specimen security.

small: 30mm X 50mm which includes a 7mm flap
medium: 45mm X 73mm which includes a 7mm flap
large: 75mm X 95mm which includes a 7mm flap

Item	Description	Qty
BIO3045W	White, 30 x 50 mm	PK/100
BIO3045WM	White, 30 x 50 mm	Bulk/1000
BIO3045Y	Yellow, 30 x 45 mm	PK/100
BIO3045YM	Yellow, 30 x 45 mm	Bulk/1000
BIO3045YW	White; Yellow, 30 x 45 mm	Bulk/1000 (500/EA)
BIO4573W	White, 45 x 73 mm	PK/100
BIO4573WM	White, 45 x 73 mm	Bulk/1000
BIO7595W	White, 75 x 95 mm	PK/100
BIO7595WM	White, 75 x 95 mm	Bulk/1000

Easy Open

Convenient Packaging

**Like Histo Gel?
Try Matrix SPG**



HistoGel™

For embedding cytology specimens, cell blocks and small histology specimens.

Item	Description	Vol	Qty
HG1012	HistoGel Vial	10mL	CS/12
HG10144	HistoGel Vial	10mL	CS/144

**Vortex
Cassette
Shown**



- **Easy to use**
- **Heat to liquefy (Microwave or Waterbath)**
- **Dispense and Encapsulate**

Matrix SPG™

Matrix SPG™ has a unique property of liquefying and solidifying, to aid in the capture, retention and protection of delicate tissues or cytology collections. Matrix SPG™ remains solid/semi-solid until heated above 65-70°C. Matrix SPG™ remains liquid until chilled below 35-40°C. This allows Matrix SPG™ to be heated above the liquefying temperature, cooled to a specimen safe 50-55°C, applied to the specimen and still remain solid for modern processors and wax filtration.

Item	Description	Vol	Qty
SPG012	Squeeze Tube	10mL	PK/12

Bio-Paper™ Biopsy Wraps

Bio-Paper™ Biopsy Wraps are sections of specialty filter paper cut to a convenient ready-to-use size.

They are available colored blue to help facilitate location of small biopsy specimens following processing and are available in dispenser packs for your convenience. Bio-Paper™ Biopsy Wraps are also available white and in a variety of sizes.



Blue		
Item	Description	Qty
BB0023	Blue 2" x 3" (51 mm x 76 mm)	BX/500
BB0024	Blue 2.76" x 4" (70 mm x 100 mm)	BX/500

White		
Item	Description	Qty
BB0202W	White Square, 2" x 2" (51 mm x 51 mm)	BX/500
BB0024-W	White 2.76" x 4" (70 mm x 100 mm)	BX/500

Biopsy Pads

Special thin non-stick foam (1" x 1.125") allows for optimal fluid transfer with virtually no carryover. Pressure on biopsy is greatly reduced decreasing occurrence of artifact. Available in Blue, Black, Yellow and White.

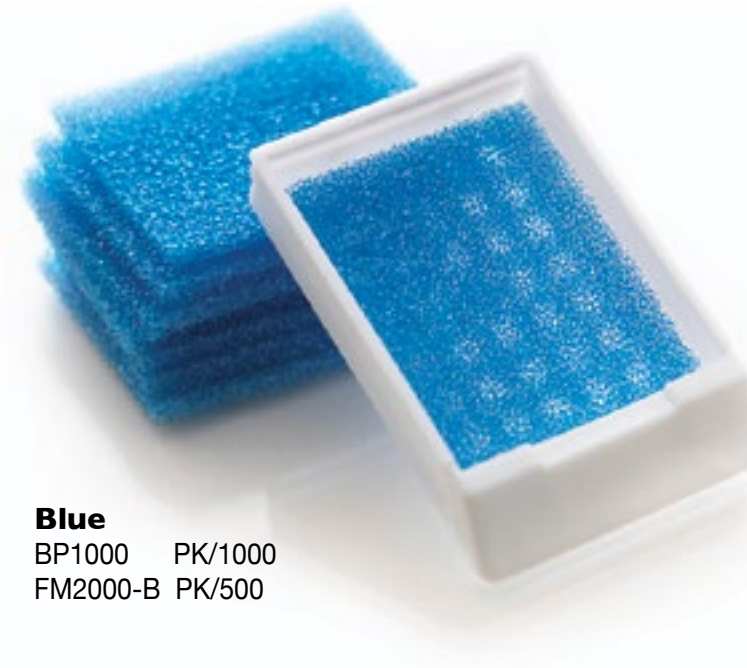

Blue
BP1000 PK/1000
FM2000-B PK/500



White
BP1000W PK/1000
FM2000-W PK/500



Yellow
BP1000Y PK/1000
FM2000-Y PK/500

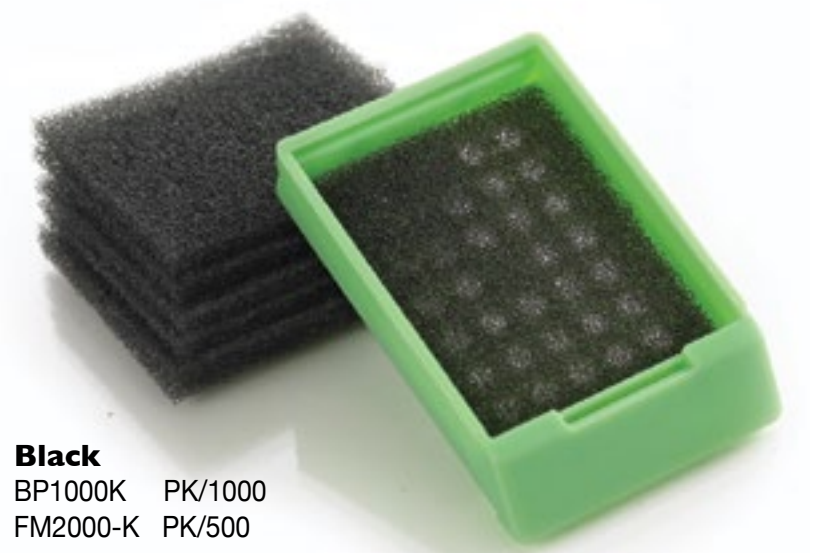

Black
BP1000K PK/1000
FM2000-K PK/500

Folding Biopsy Papers (Tri-Fold and Vortex)

- ▶ Perforated folding filter paper for containing biopsies during processing.
- ▶ Special tri-fold design folds once and then one more time to secure biopsy completely.
- ▶ Papers fit edge to edge in cassette ensuring proper biopsy security.
- ▶ Easy security at time of grossing, efficient “unwrapping” during embedding.
- ▶ Papers available in WHITE or BLUE version for optimal biopsy color contrast.
- ▶ Oval papers for Vortex Biopsy and Vortex Micro.
- ▶ Available in CS/500 or CS/2500 (5 boxes of 500)

Item	Description	Qty
X23285	Vortex™ Micro (hinged cassette) Paper	CS/500
X25300	Vortex™ Biopsy (one piece cassette) Paper	CS/500
DX26280	BLUE Cassette Paper (Tri-fold Secure)	CS/500
DX26280-5	BLUE Cassette Paper (Tri-fold Secure)	CS/2500
DX26290	WHITE Cassette Paper (Tri-fold Secure)	CS/500
DX26290-5	WHITE Cassette Paper (Tri-fold Secure)	CS/2500



Paper Bio-Bags

Paper Biopsy Bags manufactured by CDI provide security and an artifact-free environment for processing. Easy Load, Easy Open.

Item	Description	Qty
BBG100	7 cm x 7 cm	CS/600
BBG200	7.5 cm x 5 cm	CS/500
BBG044	4 cm x 4 cm	CS/600





Designed for embedding or delicate grossing.
4 STYLES:
 Curved serrated or smooth tip.
 Straight serrated or smooth tip.

5" Embedding Orientation Forceps



EYE DRESSING FORCEP

Tip	Straight Smooth	Straight Serrated	Curved Smooth	Curved Serrated
Individual	99-2273	99-2272	99-2271	99-2270
PK/5	99-2273-5	99-2272-5	99-2271-5	99-2270-5

IRIS FORCEP (WITH 1X2 TOOTH)

Tip	Straight	Half Curved	Fully Curved
Individual	99-66642	99-76642	99-86642
PK/5	99-66642-5	99-76642-5	99-86642-5



Lightweight Ergonomic Design Optimal Embedding or Grossing



Ergonomic High Quality Stainless Steel Forceps



Tip	Needle Tip	Serrated (1.5mm)	Smooth (1.5mm)	Smooth (3mm)	Tooth	Angled
5 1/2"		99-2205	99-2210			99-2200 (Serrated) 99-2202 (Smooth)
7"	99-2605	99-2260		99-2240	99-2250	99-2230 (Smooth)

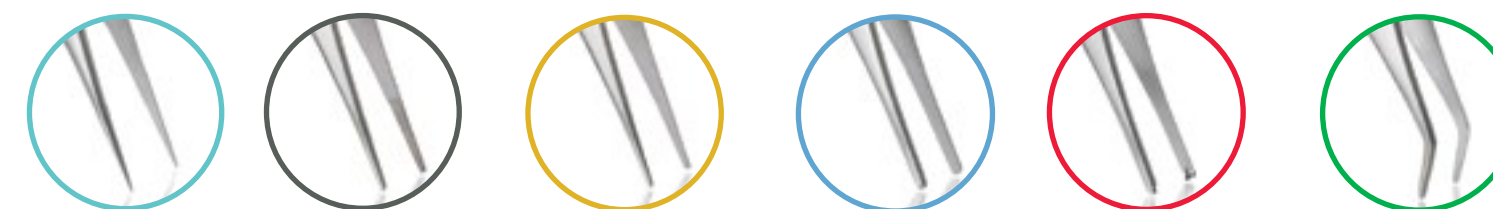

- Larger lightweight handles and effortless squeeze-tension make these forceps optimal for embedding or grossing.
- Two sizes 5 1/2" and 7" with multiple tip options.
- Perforated paddle handles for secure, slip-free grip.
- Lightweight to help reduce hand fatigue especially during extended procedures.

Forceps

Paddle Forceps

Paddle Tip forceps help facilitate easier cutting of uniform thickness specimens. Grooved handles and serrated pads. 4 sizes.

Item	Description	Pad Size	Qty
99-2280	6 ¼ inches long	2.1 cm long x 2.1 cm wide	EA.
99-2282	6 ¼ inches long	4 cm long x 3 cm wide	EA.
99-2284	6 ¼ inches long	3.5 cm long x 3 cm wide	EA.
99-2286	6 ¼ inches long	3 cm long x 3.5 cm wide	EA.
99-2287	One of each size		PK/4

99-2280 99-2284 99-2286 99-2282



- ▶ Premium German steel
- ▶ Stem Length: 13.25 cm (6 1/4")
- ▶ Serrated pads
- ▶ Available with four different paddle sizes



DRESSING FORCEPS Serrated Tips

Item	Size
99-554024	4 1/2"
99-455024	5 1/2"
99-750124	5 1/2" (extra fine)
99-265024	6"
99-885024	8"
99-406024	10"
99-026024	12"

↑
sold individually

TISSUE FORCEPS 1x2 Teeth

Item	Size
99-354124	4 1/2"
99-255124	5 1/2"
99-065124	6"
99-685124	8"
99-206124	10"
99-826124	12"

↑
sold individually

TISSUE FORCEPS 2x3 Teeth

Item	Size
99-63381	5"
99-73381	5 1/2"
99-83381	6"

↑
sold individually

TISSUE FORCEPS 3x4 Teeth

Item	Size
99-04381	5 1/2"
99-14381	6"

↑
sold individually

TISSUE FORCEPS 4x5 Teeth

Item	Size
99-44381	6"

↑
sold individually



Swiss Jeweler Style Forceps

Swiss jeweler style forceps, #3, 4 3/4" straight, narrow fine points

Item	Size
99-2288	4 3/4"

↑
sold individually

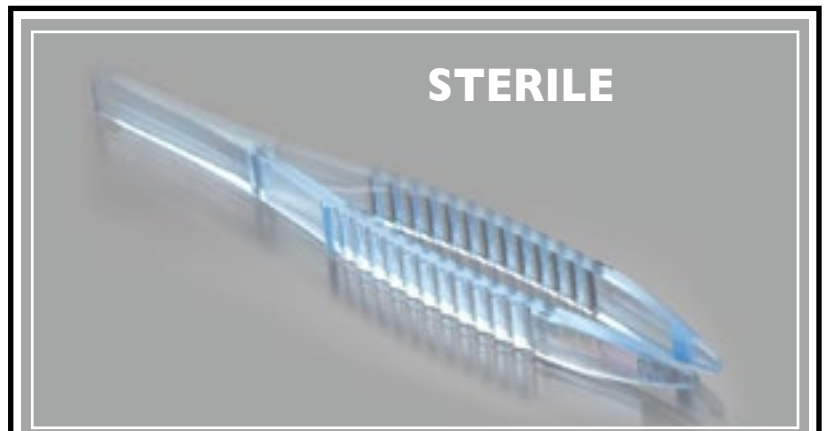

Disposable Polystyrene Sterile Blue Forceps

5 inch (12.7cm); Serrated (shown above)

Item	Size	Qty
99-DF5	5"	CS/100

Sterile Forcep *

Stainless steel 4-1/2" sterile forceps. Serrated tips. (25 forceps in individually wrapped sterile packets)

Item	Size	Qty
99-SS45	4.5"	PK/25

Sterile Instrument Pack *

Each pack includes 1 Stainless Steel forcep, #11 blade scalpel, 1 pointed scissor.

Item	Qty
99-SP309	PK/12

Sterile Instrument Pack with Cutting Board *

(One each: Forceps, Scissors, Scalpel, Cutting Board) Ideally suited for tissue to be submitted for further lab study where sterility may be needed. Each Sterile Instrument Pack contains (1) sterile disposable dissection board, (1) fine-tipped forcep, (1) rigid plastic scalpel holder with a #11 blade and (1) stainless steel pointed scissor. Scissors and forceps can be re-sterilized by autoclaving.

Item	Qty
99-SP609	PK/10

*Item not shown

German Steel Scissors

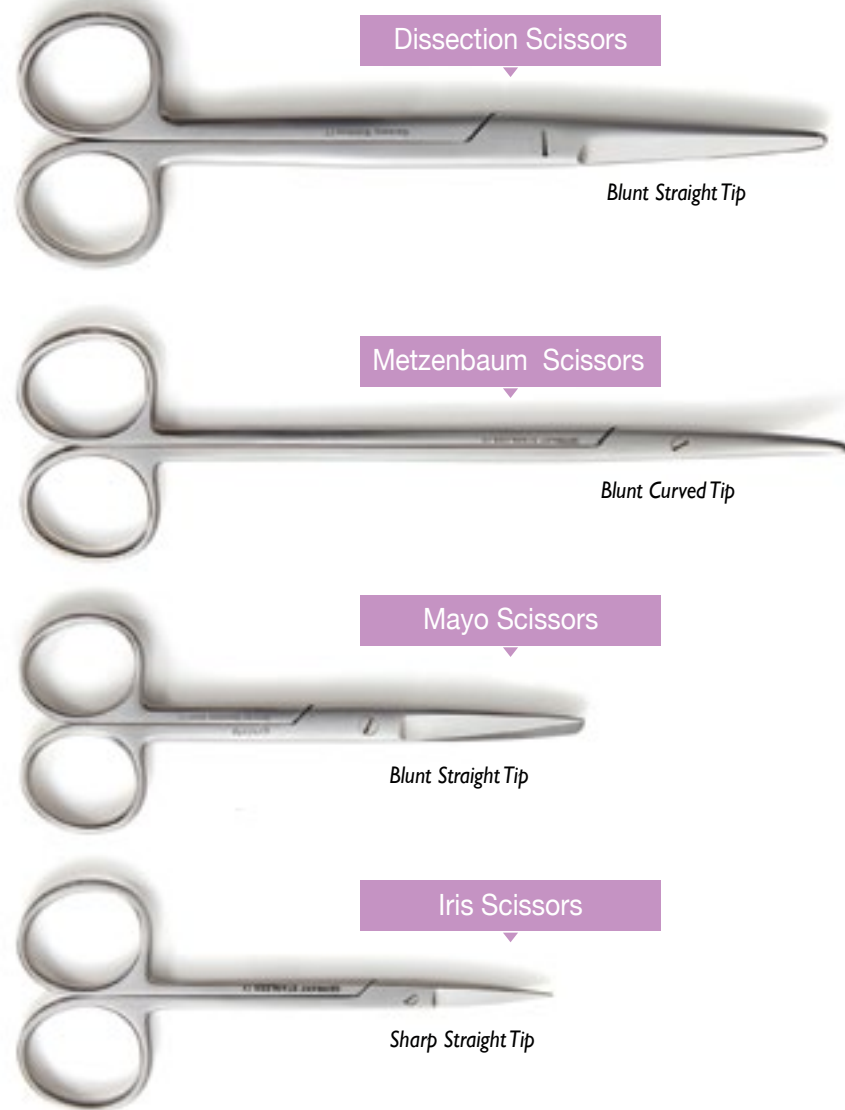

Dissection Scissors

Item	Description	Size
99-5010	Blunt-Blunt, Straight Tip	4.5 inches
99-5011	Blunt-Blunt, Curved Tip	4.5 inches
99-5012	Sharp-Blunt, Straight Tip	4.5 inches
99-5013	Sharp-Blunt, Curved Tip	4.5 inches
99-5014	Sharp-Sharp, Straight Tip	4.5 inches
99-5015	Sharp-Sharp, Curved Tip	4.5 inches
99-5016	Blunt-Blunt, Straight Tip	5.5 inches
99-5017	Blunt-Blunt, Curved Tip	5.5 inches
99-5018	Sharp-Blunt, Straight Tip	5.5 inches
99-5019	Sharp-Blunt, Curved Tip	5.5 inches
99-5020	Sharp-Sharp, Straight Tip	5.5 inches
99-5021	Sharp-Sharp, Curved Tip	5.5 inches
99-5022	Blunt-Blunt, Straight Tip	6.5 inches
99-5023	Blunt-Blunt, Curved Tip	6.5 inches
99-5024	Sharp-Blunt, Straight Tip	6.5 inches
99-5025	Sharp-Blunt, Curved Tip	6.5 inches
99-5026	Sharp-Sharp, Straight Tip	6.5 inches
99-5030	Blunt-Blunt, Straight Tip	11 inches
99-5031	Blunt-Blunt, Curved Tip	11 inches

Metzenbaum Scissors

Item	Description	Size
99-5002	Blunt-Blunt, Straight Tip	4.5 inches
99-5003	Blunt-Blunt, Curved Tip	4.5 inches
99-5004	Blunt-Blunt, Straight Tip	5.5 inches
99-5005	Blunt-Blunt, Curved Tip	5.5 inches
99-5006	Blunt-Blunt, Straight Tip	7 inches
99-5007	Blunt-Blunt, Curved Tip	7 inches

Mayo Scissors

Item	Description	Size
99-5000	Blunt-Blunt, Straight Tip	6.75 inches
99-5001	Blunt-Blunt, Curved Tip	6.75 inches
99-5028	Blunt-Blunt, Straight Tip	9 inches
99-5029	Blunt-Blunt, Curved Tip	9 inches

Iris Scissor

Item	Description	Size
99-5008	Sharp-Sharp, Straight Tip	4.5 inches
99-5009	Sharp-Sharp, Curved Tip	4.5 inches

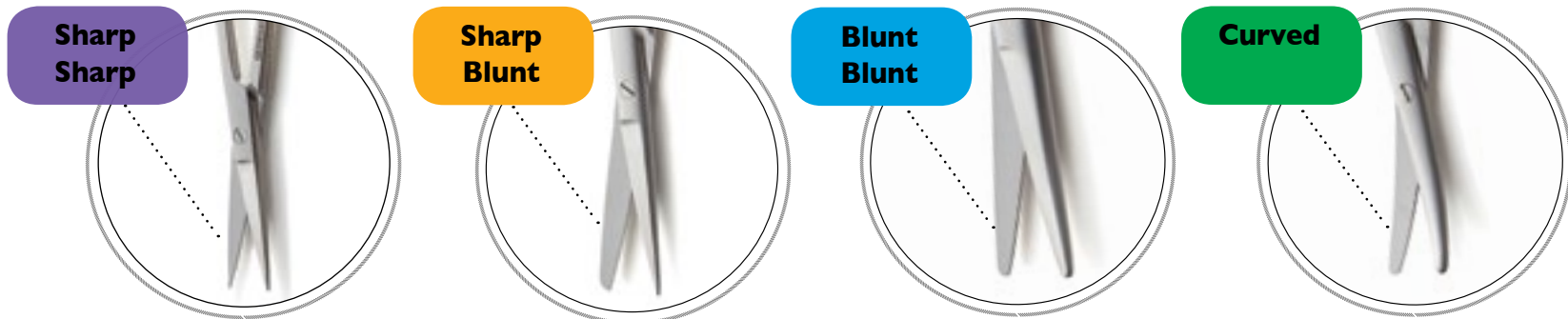

Replaceable Tip Scissors, Feather®

Replaceable tip scissors. 5,6, and 7 inch stainless steel dissection scissors. Replace tips when dull. Easy, efficient, and cost effective.

Item	Description	Qty
RT0005	5 in. Scissor Tips	SET of 6
RT0006	6 in. Scissor Tips	SET of 6
RT0007	7 in. Scissor Tips	SET of 6
RTC015	5 in. Combo	One handle with Set of 6 Tips
RTC016	6 in. Combo	One handle with Set of 6 Tips
RTC017	7 in. Combo	One handle with Set of 6 Tips
RTS555	5 in. Scissor Handle	with one set of tips
RTS666	6 in. Scissor Handle	with one set of tips
RTS777	7 in. Scissor Handle	with one set of tips



Restore 4™, Enzymatic Instrument Cleaner

Restore 4™ is an enzymatic detergent instrument cleaner. 4 enzymes, Lipase (for fat), Amylase (for starch), Carbohydrase (for high starches), and Protease (for blood) efficiently and systematically break down proteinaceous bioburden. The detergent combination provides a light foaming action to aid in cleaning and is 100% biodegradable. Available in a concentrate and working solution.

Item	Description	Qty
RE1000	Concentrate-Gal (3.8L)	EA.
RE3800	Working Solution-Gal (3.8L)	EA.





CDI's Bio-Ruler (Super flexible Plastic with lift-tab)

Specifications:

- ▶ Four versions depending on user preference: left-handed, right-handed, upside down, right-side up
- ▶ 010 thickness plastic, reusable, smudge-proof, chemical and liquid resistant
- ▶ Super flexible cut out lift-tab for easy pick up from wet surfaces
- ▶ Double-sided: Available in inches/metric or metric/metric
- ▶ White- 20 cm lengths

Item	Description	Qty
PRL1111	Inches/Metric SIDE A (Same Direction) Metric/Metric SIDE B (Opposite Direction)	PK/50
PRL1112	Metric/Metric SIDE A (Opposite Direction) Metric/Metric SIDE B (Same Direction)	PK/50

"Pad of Paper" Disposable Paper Rulers

"Pad of Paper" Disposable paper rulers, great for photography with CASE, SPECIMEN, and DATE area for marking.

Item	Description	Qty
RL1000PL	Disposable Paper Rulers	PK/500

T-Pin, Specimen Pins

Smooth T-bar head and sharp point for pinning specimens
2" (50.8mm) length, 1/2" head (13mm)

Item	Description	Qty
TP1002	Nickel-plated steel	BX/100

Cork Board

Extra smooth grain cork for grossing, pinning specimens, or other general laboratory tasks. 8" x 12", 1/2" thick. PK/12

Item	Description	Qty
CC0812	Cork Board	PK/12



Disposable Underpads "Blue Chucks"

- ▶ Highly absorbent, soft fluff fill
- ▶ Waterproof, non-skid blue backing
- ▶ Sealed on all four sides to prevent leakage
- ▶ Underpads with polymer offer extra absorbency and protection
- ▶ Disposable Underpads are not biodegradable

Item	Description	Qty
CDI1340	17x24 Tissue Fill (2 ply)	CS/300
CDI1341	17x24 (22g)	CS/300
CDI1342	23x24 (31g)	CS/200
CDI1343	23x36 (45g)	CS/150
CDI1346	23x36 (60g)	CS/150
CDI1347	30x30 (105g) with polymer	CS/100
CDI1348	30x36 (90g) with polymer	CS/100

Disposable Underpads

Teasing Needles

High-quality needles are made of durable stainless steel. Available with wood or plastic handles.

Light, comfortable, one-piece teasing needles
Attached 45mm straight or angled needle
Overall length: 5.75" (146mm)



Item	Description	Size	Qty
Wooden Handle:			
CDI331050-6	Straight Point	14 cm	PK/6
CDI331051-6	Angled Point	14 cm	PK/6
Plastic Handle:			
CDI331050PL-6	Straight Point	14 cm	PK/6
CDI331051PL-6	Angled Point	14 cm	PK/6



Cutting Board and Board Base

Cutting Board

Offers a large surface on one side and two smaller ones on the other side. On one side: large cutting area including dimensional scales in inches and centimeters. Other side: offers 2 cutting boards half the size. All corners have rubber feet giving more stability to the working surface. Made of heavy-duty stain resistant thick polyethylene

Two Sizes:

575 mm x 400 mm x 12.5 mm (23" x 16" x 1/2" H)
330.2 mm x 279.4 mm x 12.5 mm (13" x 11" x 1/2" H)-Cutting Board Jr.

Board Base (for use with M620 Cutting Board)

Heavy base used to elevate the cutting board to the right height. 481 mm x 656 mm x 91mm (19 1/4" x 26 1/4" x 3 5/8" H)

Item	Description	Qty
M620	Cutting Board	EA.
M618	Cutting Board Jr.	EA.
M625	Board Base for M620	EA.

Cutting Board

- ▶ Light Blue cutting board
- ▶ Non-slip feet
- ▶ 23" x 16" x 1/2" thick

Item	Description	Qty
CB2316	Cutting Board	EA.



Cutting Board

Raised dissecting board -high density polyethylne -White

- ▶ Non-slip feet
- ▶ 20" x 15" x .75" thick, (4) 3"7cm Legs

Item	Description	Qty
RDB1000	Cutting Board	EA.

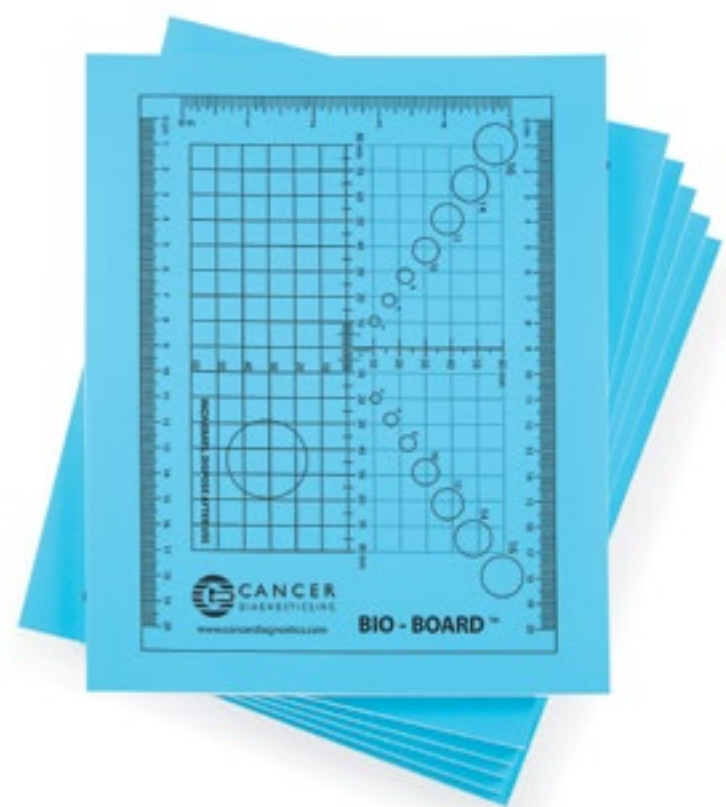

Bio Board™

Economical cut resistant disposable foam core board with light blue color provides great color contrast. Use for routine grossing, frozen sections and photography.

Board size: 8" x 10"

Item	Description	Qty
BB0811-60	Bio Board	BX/60

- ▶ Preprinted measurements
- ▶ Incinerate or dispose after use



VaporPad™ Original

Formalin Neutralizer Pads that encapsulate and neutralize harmful vapors to greatly reduce exposure to Formaldehyde. Light blue contained work surface offers contrast for all biopsies. Cut resistant, durable and disposable.

Item	Description	Qty
VP0810	8" x 10"	PK/25
BLK0810	8" x 10"	BULK/400
VP01114	11" x 14"	PK/25
BLK1114	11" x 14"	BULK/400
VP01620	16" x 20"	PK/25
VP06014	Roll 60' x 14"	EA.



VaporPad™ Ultra BLUE

VaporPad™ Ultra BLUE version offers blue poly-coated surface for optimal color contrast and cutting performance.

Item	Description	Qty
UPB0811	8" x 11"	PK/25
UPB1115-PK	11" x 15"	PK/25
UPB1115	11" x 15"	CS/100
UPB1520-PK	15" x 20"	PK/25
UPB1520	15" x 20"	CS/100

VaporPad™ Ultra (without blue covering)

VaporPad™ Ultra, Formalin Neutralizer Pads provide an effective way for lab personnel to guard against formaldehyde vapors and exposure by allowing formalin penetration into a highly absorbent core.

Item	Description	Qty
UP0811	8" x 11"	PK/25
UP1115	11" x 15"	PK/25



FAN PAD G.L.™

Designed to facilitate the reduction of formaldehyde vapors by absorbing and neutralizing formaldehyde, glutaraldehyde and other aldehydes. FAN PAD GL™ provides excellent vapor control during gross examination, dissecting, transporting, or transferring formalin fixed tissue. FAN Pads are also used for vapor control in storage of formalin, formalin fixed tissue containers and for small formalin spills. Once the formalin solution is absorbed, the FAN PAD GL™ will convert formaldehyde and other aldehydes to a non-hazardous polymer, eliminating the source of harmful vapors making the work area a lot safer.



FAN PAD-GL™ "Mini"

- ▶ 330 Absorbent Sheets/case
- ▶ Each Sheet Size: 11" x 10"
- ▶ Each sheet absorbs & neutralizes up to 20ml of 10% formalin
- ▶ Blue is an excellent background during tissue grossing

Item	Qty
CDIFAN55	330 Sheets/CS

FAN PAD-GL™ "Small"

- ▶ 48 Super Absorbent Pads/case
- ▶ Working Surface 6" x 14"
- ▶ Absorbs & neutralizes up to 200ml of 10% formalin

Item	Qty
CDIFAN614	48 Pads/CS

FAN PAD-GL™ "Large"

- ▶ 30 Super Absorbent Pads/case
- ▶ Working surface 9" x 21"
- ▶ Absorbs & neutralizes up to 400ml of 10% formalin

Item	Qty
CDIFAN825	30 Pads/CS

FIXATIVES AND DECALCIFIERS

OPTIMIZATION FOR CELLULAR INTEGRITY

Reagents • Fixatives • Transport Solutions • Decalcifiers



10% Neutral Buffered Formalin

All Fix™, 10% Zinc Formalin and 10% Alcoholic Formalin



20% Neutral Buffered Formalin Concentrate (4:1)
20% Neutral Buffered Formalin is intended as a general purpose fixative for all tissues to be examined by light microscopy. It is useful for surgical tissues and necropsy specimens. (NOT PICTURED)

Item	Volume	Qty
FX1000-20	5 Gallon Cube	EA.

Neutral Buffered Formalin Concentrate (4:1)
Combine 1 part concentrate to 4 parts water to make ready to use Neutral Buffered Solution.

Item	Volume	Qty
FX1014	Gal. (3.8L)	CS/4
FX1015	5 Gallon Cube	EA.
FX1016	55 Gallon Drum	EA.

10% Neutral Buffered Formalin
Formulated for consistency and buffered to a neutral pH 7.0. A general purpose fixative for all tissues types.

Item	Volume	Qty
FX1000	5 Gallon Cube	EA.
FX1001	2.5 Gallon Cube	EA.
FX1002	Gal. (3.8L)	EA.
FX1003	Gal. (3.8L)	CS/4
FX1013	55 Gallon Drum	EA.

10% Neutral Buffered Formalin, with Eosin Tint
Intended for use as general histological fixative. The addition of the eosin to the formulation allows the user to more easily visualize small fragments of tissue during the transfer of the tissue from the fixative to the tissue cassette.

Item	Volume	Qty
FX1000-T	5 Gallon Cube	EA.
FX1001-T	2.5 Gallon Cube	EA.
FX1002-T	Gal. (3.8L)	EA.
FX1003-T	Gal. (3.8L)	CS/4
FX1013-T	55 Gallon Drum	EA.



All Fix™ Formalin Substitute
A general purpose fixative formulated as a substitute for 10% Neutral Buffered Formalin that contains no Formaldehyde/Formalin. All Fix™ is buffered to produce optimum staining with hematoxylin and eosin and produces histologic results similar to or better than those following fixation with 10% neutral buffered formalin.

Item	Volume	Qty
FX1073	Gal. (3.8L)	EA.
FX1074	Gal. (3.8L)	CS/4
FX1075	5 Gallon Cube	EA.

10% Zinc Formalin
An excellent routine fixative that preserves the immunoreactivity of tissue antigens better than 10% NBF.

Item	Volume	Qty
FX1017	5 Gallon Cube	EA.
FX1018	2.5 Gallon Cube	EA.
FX1019	Gal. (3.8L)	CS/4

10% Alcoholic Formalin
Alcoholic formalin blend is an ideal year-round fixative but is especially suitable for laboratories in colder climates. The addition of 10% alcohol makes the solution more resistant to freezing temperatures.

Item	Volume	Qty
CX1027	5 Gallon Cube	EA.
FX1027	Gal. (3.8L)	CS/4
FXG027	Gal. (3.8L)	EA.

Pureview® Fixative



Pureview® NBF

Pureview® NBF produces no precipitates in the presence of alcohol to let you skip the routine warm water processing flush. Pureview® NBF is specifically formulated to inhibit formation of salts within tissue processor lines of all processors and can replace regular 10% NBF without any adjustments to procedures or protocols.

Compatible with CDI's N-15 formalin neutralizer and all industry neutralizers.

Item	Volume	Qty
FX1048	Gal (3.8L)	CS/4
CX1048	5 Gallon Cube	EA.

Using VIP Fixative?
Try Pureview® NBF



Millonig's PBF

Millonig's PBF (pH 7.4) is a non-coagulative additive fixative. Millonig's PBF penetrates quickly. An enhanced buffering formulation optimizes light microscopy and immunohistochemistry specimens. Can be used in place of traditional 10% NBF.

Item	Volume	Qty
FX1038	Gal. (3.8L)	EA.
FX1039	5 Gallon Cube	EA.
FX1040	Gal. (3.8L)	CS/4

37% Formaldehyde

Contains methanol as a stabilizer.

Item	Volume	Qty
FX0096	5 Gallon Cube	EA.
FX0098	Gal. (3.8L)	CS/4
FX0099	Gal. (3.8L)	EA.

3% Non Buffered Gluteraldehyde

For electron microscopy primary fixation.

Item	Volume	Qty
GX038	Gal (3.8L)	EA.

(NOT PICTURED)



Methacarn Fixative

Used on tissues to be paraffin-embedded and immuno-chemically stained. This fixative preserves tissue antigenicity better than Neutral Buffered Formalin and preserves certain epitopes exceptionally well for immunoperoxidase and other immunochemical staining.

Item	Volume	Qty
FX1043	Liter (1000 mL)	EA.
FXG043	Gal. (3.8L)	EA.

Trump's Fixative

Trump's Fixative is formulated for tissues to be examined by electron microscopy.

Item	Volume	Qty
FX1044	Liter (1000 mL)	EA.
FXG044	Gal. (3.8L)	EA.

Davidson's Fixative

A rapid fixative which gives good nuclear detail with minimal formalin pigment. Fixation of small specimens is rapid. Davidson's may be used for overnight fixation of fatty lymph nodes and is useful for preparing tumors, bone marrow specimens, gynecologic, and fatty breast biopsies.

Item	Volume	Qty
FX1041	Gal. (3.8L)	EA.

Modified Carnoy's Fixative

Used for fixation of tissues to preserve RNA for methyl green pyronine stain. Some procedures also use Modified Carnoy's as a fixative for tissues to be stained and studied with selected immunochemical stains.

Item	Volume	Qty
FX1047	Gal. (3.8L)	EA.



Michel's Wash Solution
Michel's Wash Solution is used to rinse Michel Transport Medium from the tissue after transport and prior to freezing. Specimens received in transport medium should be washed in three changes of washing solution (10 minutes for each wash).

Item	Volume	Qty
FX4112	Gal. (3.8L)	CS/4
FX4113	Liter (1000 mL)	EA.
FX4114	500 mL	EA.

Michel's Solution - Transport Medium
Michel Transport Medium provides a stable medium for transport and temporary holding of fresh (unfixed) tissues, such as skin, rectal, renal, and oral mucosa biopsies, which will undergo subsequent frozen sectioning and immunofluorescence studies. Michel Transport Medium is not suitable for transporting cells for flow cytometry or for tissues used for fluorescent in-situ hybridization (FISH). This product does not have any fixative properties.

Item	Volume	Qty
FX1046	Gal. (3.8L)	EA.
FX1046-500	500 mL	EA.
FX1046-20	20mL Prefilled	BX/32
FX1046-256	20mL Prefilled	BX/256



B-5 Substitute Fixative, B5-Sub™
Formulated to replace B-5 Fixative and produce results that mimic fixation properties of B-5 without the hazards associated with Mercury.

Item	Volume	Qty
FX1058	500 mL	EA.
FX1061	Gal. (3.8L)	EA.
FX1062	Gal. (3.8L)	CS/4

Bouin's
Intended as a special fixative or a mordant for tissues to be examined by light microscopy, and is useful for necropsy and surgical tissue specimens.

Trichrome stains are enhanced by Bouin's and tissue sections show improved staining following mordant treatment with Bouin's.

Item	Volume	Qty
FX1035	Gal. (3.8L)	EA.
FX1036	5 Gallon Cube	EA.



Reveal® Lymph Node Revealer and Fixative

Reveal® is used on fresh tissue sections during or immediately following gross pathology. A versatile lymph node revealing solution, capable of effectively fixing a variety of tissues (kidney, colon, breast, fatty sections, lymph nodes and other similar tissue types). Use 10 times volume of specimen.

Item	Volume	Qty
FX1063	Liter (1000mL)	EA.
FX1064	Gal. (3.8L)	EA.
FX1065	1 Gallon Cube	EA.
FX1066	2.5 Gallon Cube	EA.
FX1067	5 Gallon Cube	EA.

Fast•Fix™

A rapid fixative formulated to be **used at the grossing station** to improve fixation and specimen processing. It penetrates and fixes fatty tissue rapidly and is compatible with all other fixatives.

Item	Volume	Qty
FX1053	Gal. (3.8L)	EA.
FX1054	Gal. (3.8L)	CS/4
FX1055	2.5 Gallon Cube	EA.
FX1056	5 Gallon Cube	EA.
FX1057	Liter (1000mL)	EA.



Like Pen-Fix™? Try Lipo-Fix™

Particularly well suited for fatty tissues. Penetration rate three times faster than 10% NBF.

Lipo-Fix™ Alcoholic, (Rapid Fixative)

Formulated to fix and dehydrate simultaneously. Excellent for bowel and breast specimens. In gross room, place larger specimens arriving in routine fixative into Lipo-Fix™ to enhance processing. Additionally, Lipo-Fix™ can be used on second or third stations of the processor as a secondary fixative.

Item	Volume	Qty
FX9200	Gal. (3.8L)	EA.
FX9201	Gal. (3.8L)	CS/4

Hollandes Fixative

A widely used fixative for biopsy specimens of the gastrointestinal tract.

Item	Volume	Qty
FX1042	Gal. (3.8L)	EA.



CalFor®

Calfor® is formulated to fix and decalcify simultaneously. Fresh tissue can be placed directly into Calfor; Needle biopsies may be completely fixed and decalcified in one hour or less. Small bone specimens and calcified arteries may be completely fixed and decalcified in 2-4 hours. An excellent decalcifier for large dense specimens for fixation and to begin decalcification. Calfor is a proven formulation for ISH and IHC.

Item	Volume	Qty
CFQ025	1 Gallon Cube	EA.
CFQ038	Gal. (3.8L)	EA.
CFQ100	Liter (1000mL)	EA.
CFQ400	Liter (1000mL)	CS/4
CFQ438	Gal. (3.8L)	CS/4

DehCL+™

DehCL+™ is formulated to work faster than DehCL™ (Original Formulation) and can be used on all types of calcified specimens including bone marrow samples. Fixed needle biopsies will decalcify in less than one hour. Sections will cut with ease and all H&E and special stains exhibit excellent stain detail.

Item	Volume	Qty
DP025	1 Gallon Cube	EA.
DP038	Gal. (3.8L)	EA.
DP100	Liter (1000mL)	EA.
DP400	Liter (1000mL)	CS/4
DP438	Gal. (3.8L)	CS/4

EDTA™ (Acid Free)

A decalcifying solution formulated to decalcify bone and retain antigenicity for immunochemical studies. EDTA™ decalcifier is acid free to maintain nucleic acid integrity.

Item	Volume	Qty
EDT025	1 Gallon Cube	EA.
EDT038	Gal. (3.8L)	EA.
EDT100	Liter (1000mL)	EA.
EDT400	Liter (1000mL)	CS/4
EDT438	Gal. (3.8L)	CS/4

Decal Endpoint Test Kit

Item	Volume	Qty
DTK250	250mL	EA.

CalFor*™

Calfor*™ is a fast yet exceptionally gentle bone decalcifier that has been formulated from semiconductor grade formic acid, highly purified reagent grade water and EDTA. Calfor* is formulated as a general purpose decalcifier for all routine specimens, and because it will safely decalcify bone without destroying antigen sites, it works especially well to decalcify tissue for immunohistochemistry.

Item	Volume	Qty
CF025	1 Gallon Cube	EA.
CF038	Gal. (3.8L)	EA.
CF100	Liter (1000mL)	EA.
CF400	Liter (1000mL)	CS/4
CF438	Gal. (3.8L)	CS/4

Niter-Cal™

Niter-Cal™ is a mild solution that works rapidly while exhibiting excellent results. Made from semiconductor grade acid and highly purified reagent grade water, Niter-Cal™ is an excellent decalcifier on all bone specimens from bone marrow to cortical bone where time is a critical element. While it is a very mild solution, it works rapidly with beautiful results.

Item	Volume	Qty
NC025	1 Gallon Cube	EA.
NC038	Gal. (3.8L)	EA.
NC100	Liter (1000mL)	EA.
NC400	Liter (1000mL)	CS/4
NC438	Gal. (3.8L)	CS/4

XL-Cal® Decalcifier and XL-Cal® Immuno Decalcifier

A hydrochloric acid solution formulated for rapid decalcification. Immerse fixed tissue (trimmed between 0.2cm to 0.5cm) in a volume 20 times the volume of the specimen and change the solution after the first 2 hours of decalcification. Sectioning properties are excellent.

Item	Volume	Qty
XLQ400	Liter (1000mL)	CS/4 *
XLQ025	1 Gallon Cube	EA. *
XLG438	Gal. (3.8L)	CS/4 *
XLG946	Gal. (3.8L)	EA. *
XLH101	1 Gallon Cube	EA. **

* XL-Cal Decalcifier
** XL-Cal Immuno Decalcifier

DehCL™

DehCL™ is a mild decalcifier formulated from semiconductor grade hydrochloric acid, EDTA, and highly purified reagent grade water. DehCL™ can be used to safely decalcify all types of calcified specimens and is gentle enough that most specimens can be left in DehCL™ overnight without worry of over-decalcification.

Item	Volume	Qty
DC025	1 Gallon Cube	EA.
DC038	Gal. (3.8L)	EA.
DC100	Liter (1000mL)	EA.
DC400	Liter (1000mL)	CS/4
DC438	Gal. (3.8L)	CS/4

IMMUNO-4™

Immuno-4™ is a very mild formic acid decalcifier. It is formulated from semiconductor grade formic acid and highly purified reagent grade water. Immuno-4 should be used when you are decalcifying bone for immunohistochemistry. Immuno-4 preserves the antigenicity of both decalcified needle biopsies of bone marrow and large specimens for immunochemical studies.

Item	Volume	Qty
M4025	1 Gallon Cube	EA.
M4038	Gal. (3.8L)	EA.
M4100	Liter (1000mL)	EA.
M4400	Liter (1000mL)	CS/4
M4438	Gal. (3.8L)	CS/4



PRE-FILLED



IMPACT RESISTANT CLEAR POLYPROPYLENE
PREFILLED FORMALIN JARS

Pre-Filled Jars • Prostate Kits • Specimen Container Cups

Specimen Containers

Pre-Filled Formalin Jars, 10% NBF; Pre-Filled Pak, Brown/Kraft Box

Item	Description	Klick-Top Jar	Quantity
FX1004	7 mL bottle w/5 mL fill		CS/500 (easy dispense cardboard tray)
FX1005	7 mL bottle w/5 mL fill		CS/100 (easy dispense cardboard tray)
FX1006	20 mL	✓	CS/256 (BX/32, 8 BX/CS)
FX1006-HPY	20mL Tote Pre-Filled Pak (opposite Page)	✓	CS/4 (128 Jars)
FX1007	40 mL	✓	CS/256 (BX/32, 8 BX/CS)
FX1008	60 mL	✓	CS/256 (BX/32, 8 BX/CS)
FX1009	90 mL	✓	CS/192 (BX/24, 8 BX/CS)
FX1010	120 mL	✓	CS/96 (BX/16, 6 BX/CS)
FX1011	240 mL bottle w/150 mL fill		CS/50 (8 oz. x 50/CS)
FX1116	500 mL bottle w/300 mL fill		CS/32 (16 oz. x 32/CS)
FX1132	940 mL bottle w/500 mL fill		CS/18 (32 oz. x 18/CS)



KLICKTOP (Turn to Click)



Empty Specimen Jars (Screw Top) with lids. Jars are 95kPa compliant with leak resistant O-ring seal. Available labeled, empty or unlabeled, empty. Packs or Bulk

Item	Description	Label	No Label	Quantity
FX1004-EBB	7 mL		✓	CS/1000
FX1006-EC	20 mL		✓	CS/100
FX1006-EBB	20 mL		✓	CS/1000
FX1007-EBB	40 mL		✓	CS/600
FX1008-EBB	60 mL		✓	CS/500
FX1009-EBB	90 mL		✓	CS/400
FX1010-EBB	120 mL		✓	CS/300
FX1011-EL	240 mL	✓		CS/100
FX1011-EC	240 mL		✓	CS/100
FX1511-EL	500 mL	✓		CS/25
FX1511-EC	500 mL		✓	CS/25
FX1012-EL	940 mL	✓		CS/20
FX1012-EC	940 mL		✓	CS/20

JARS IN THIS SECTION EMPTY



Tote Pre-Filled Pak -10% NBF (Happy Meal Packaging)



Pre-Filled Containers

NBF with 10% Alcohol

Item	Vol.	Qty
FX1026	7mL	CS/196 (7mL bottle w/5mL fill)
FX1028	20mL	CS/256 (BX/32, 8 BX/CS)



All-Fix™

Item	Vol.	Qty
FX1069	20mL	CS/256 (BX/32, 8 BX/CS)



B-5 Substitute Fixative, B5-Sub™

Item	Vol.	Qty
FX1059	20mL	CS/256 (BX/32, 8 BX/CS)



Buffered Zinc Formalin

Item	Vol.	Qty
FX1020	20mL	CS/256 (BX/32, 8 BX/CS)
FX102040	40mL	CS/256 (BX/32, 8 BX/CS)



Michel's Solution

Item	Vol.	Qty
FX1046-20	20mL	BX/32
FX1046-256	20mL	CS/256 (BX/32, 8 BX/CS)



Carson Millonig's (pH 7.4) Phosphate Buffered Formalin

Item	Vol.	Qty
FX1037-20	20mL	CS/256 (BX/32, 8 BX/CS)



Bouin's Fixative

Item	Vol.	Qty
FX1035-20	20mL	CS/256 (BX/32, 8 BX/CS)



Pre-Freeze™ (Fresh Tissue Transport Medium For Frozen Sectioning)

Item	Vol.	Qty
FX1085	20mL	Bag/12



Hollandes Fixative

Item	Vol.	Qty
FX1042-20	20mL	CS/256 (BX/32, 8 BX/CS)



NBF with 10% Alcohol

Alcoholic formalin blend is an ideal year-round fixative but is especially suitable for laboratories in colder climates. The addition of 10% alcohol makes the solution more resistant to freezing temperatures.

Buffered Zinc Formalin

An excellent routine fixative that preserves the immunoreactivity of tissue antigens better than 10% NBF.

Bouin's Fixative

Intended as a special fixative or a mordant for tissues to be examined by light microscopy, and is useful for necropsy and surgical tissue specimens.

Trichrome stains are enhanced by Bouin's and tissue sections show improved staining following mordant treatment with Bouin's.

All-Fix™

A general purpose fixative formulated as a substitute for 10% Neutral Buffered Formalin that contains no Formaldehyde/Formalin. All Fix™ is buffered to produce optimum staining with hematoxylin and eosin and produces histologic results similar to or better than those following fixation with 10% neutral buffered formalin.

Michel's Solution

Michel Transport Medium provides a stable medium for transport and temporary holding of fresh (unfixed) tissues, such as skin, renal, and oral mucosa biopsies, which will undergo subsequent frozen sectioning and immunofluorescence studies. Michel Transport Medium is not suitable for transporting cells for flow cytometry or for tissues used for fluorescent in-situ hybridization (FISH). This product does not have any fixative properties.

Pre-Freeze™

A solution formulated for preservation of fresh tissue that is to be submitted for Frozen Sectioning. Perfect for transporting tissue to lab for preserving cellular structure.

B-5 Substitute Fixative

Formulated to replace B-5 Fixative and produce results that mimic fixation properties of B-5 without the hazards associated with Mercury.

Carson Millonig's

Millonig's PBF (pH 7.4) is a non-coagulative additive fixative. Millonig's PBF penetrates quickly. An enhanced buffering formulation optimizes light microscopy and immunohistochemistry specimens. Can be used in place of traditional 10% NBF.

Hollandes Fixative

A widely used fixative for biopsy specimens of the gastrointestinal tract.



**Ask about our custom kit capabilities.
All jars available with your label design.**

Prostate Biopsy Kits

Prostate-Pak™, Prostate Biopsy Kits

These kits feature 20mL vials prefilled with 10mL of 10% neutral buffered formalin. Vials are 95kPa compliant with a leak-resistant seal. All specimen locations are clearly marked within the kits, and include stickers for each lid for further identification.

Available with 6, 8, 10, 12, 14, or 16 Jars.

Item	Qty	Item	Qty
PP1006	6 Jars	PP1012	12 Jars
PP1008	8 Jars	PP1014	14 Jars
PP1010	10 Jars	PP1016	16 Jars



CoreDish™ Multiple Biopsy Containers

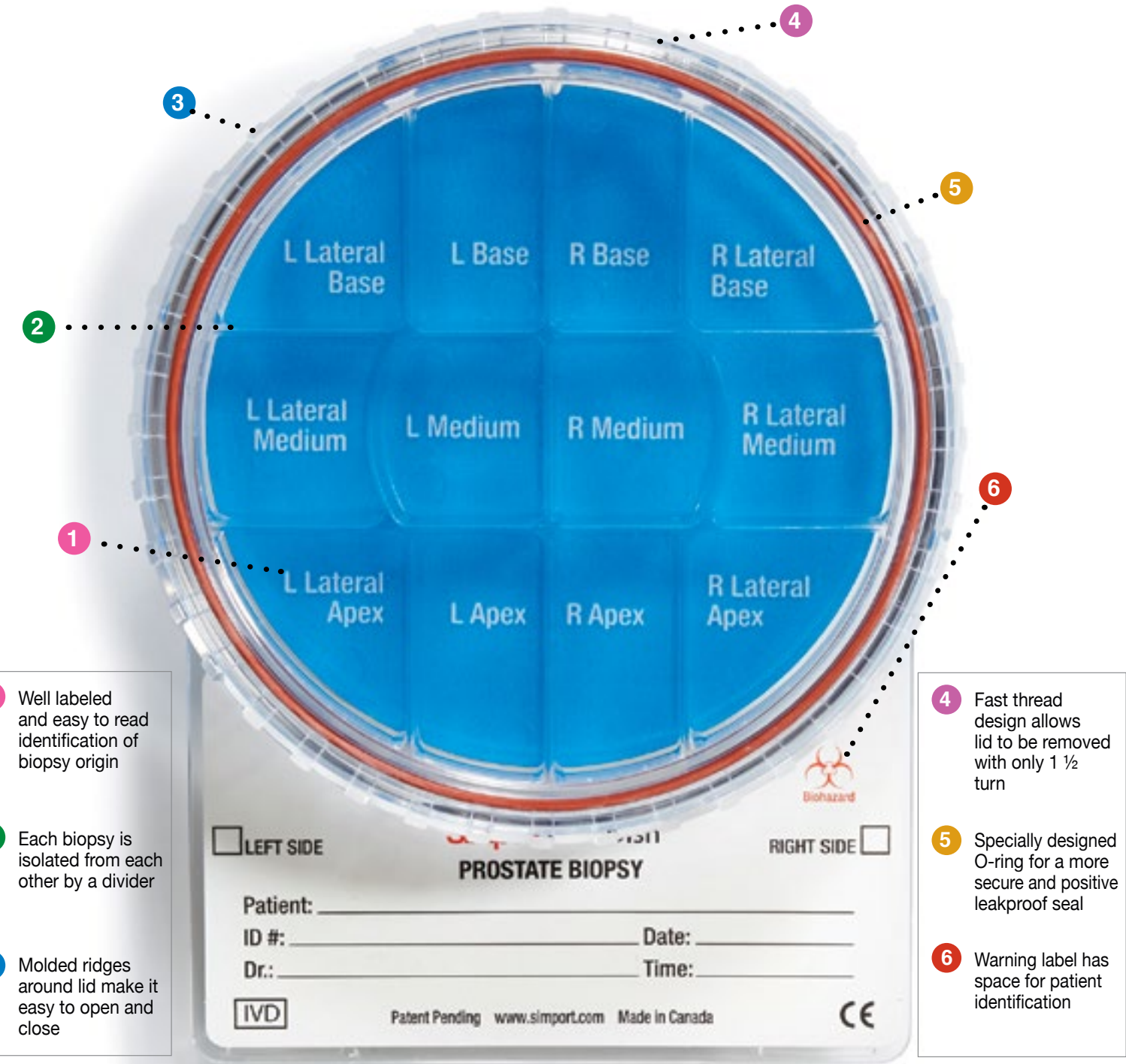

- 1 Well labeled and easy to read identification of biopsy origin
- 2 Each biopsy is isolated from each other by a divider
- 3 Molded ridges around lid make it easy to open and close

- 4 Fast thread design allows lid to be removed with only 1 ½ turn
- 5 Specially designed O-ring for a more secure and positive leakproof seal
- 6 Warning label has space for patient identification

M970-D12P

PROSTATE BIOPSY CONTAINER Half Prefilled with 10% Formalin

For prostate biopsies. Twelve compartments. An area for patient information is provided. Twelve labeled compartments: L Base, R Base, L Lateral Base, R Lateral Base, L Lateral Medial, L Medial, R Medial, R Lateral Medial, L Lateral Apex, L Apex, R Apex, R Lateral Apex. Leakproof O-ring, allows for safe and easy transport of the specimens from collection to analysis.

Cat. #	For	Compartments	Prefilled	Qty/Pk	Qty/Cs
M970-D12P	Prostate	12	YES	1	10

Specimen Containers 4 oz

4 oz container with screw-on cap available sterile (either with tab type/tamper evident or individually bagged) or bulk non-sterile.

Item	Description	Qty
STC001	4 oz sterile, individually bagged	CS/100
STC002	4 oz sterile, tab type, tamper evident	CS/100
STC003	4 oz bulk non-sterile	CS/500

85

PRE-FILLED JARS



86

PRE-FILLED JARS



Specimen Storage Containers

Specimen Storage Containers

Translucent HDPE, easy press and seal lids. Perfect for storage and inter-hospital transport.

Item	Description	Qty	Item	Description	Qty
PC8100	8 oz (short)	CS/100	PC0032	32 oz	CS/100
PC8250	8 oz (short), Bulk	CS/250	PC0064	64 oz	CS/50
PC8100-T	8 oz (tall)	CS/100	PC0085	85 oz	CS/50
PC8250-T	8 oz (tall), Bulk	CS/250	PC0160	160 oz. (with handle)	CS/25
PC0016	16 oz (short)	CS/100	PC0174	174 oz	CS/25
PC0016-T	16 oz (tall)	CS/100			



Life Latch® New Generation Screw Top Containers with Lid

Features: Screw top, moisture-resistant, vacuum-tight seal, FDA approved plastic heat transfer.

Item	Description	Qty	Item	Description	Qty
GPC1006	Container 0.6 Gal.	CS/30	GPC350	Container 3.5 Gal.	CS/8
GPC125	Container 1.25 Gal.	CS/20	GPC500	Container 5 Gal.	CS/5
GPC250	Container 2.5 Gal.	CS/10	GPC650	Container 6.5 Gal.	CS/5

Dimensions

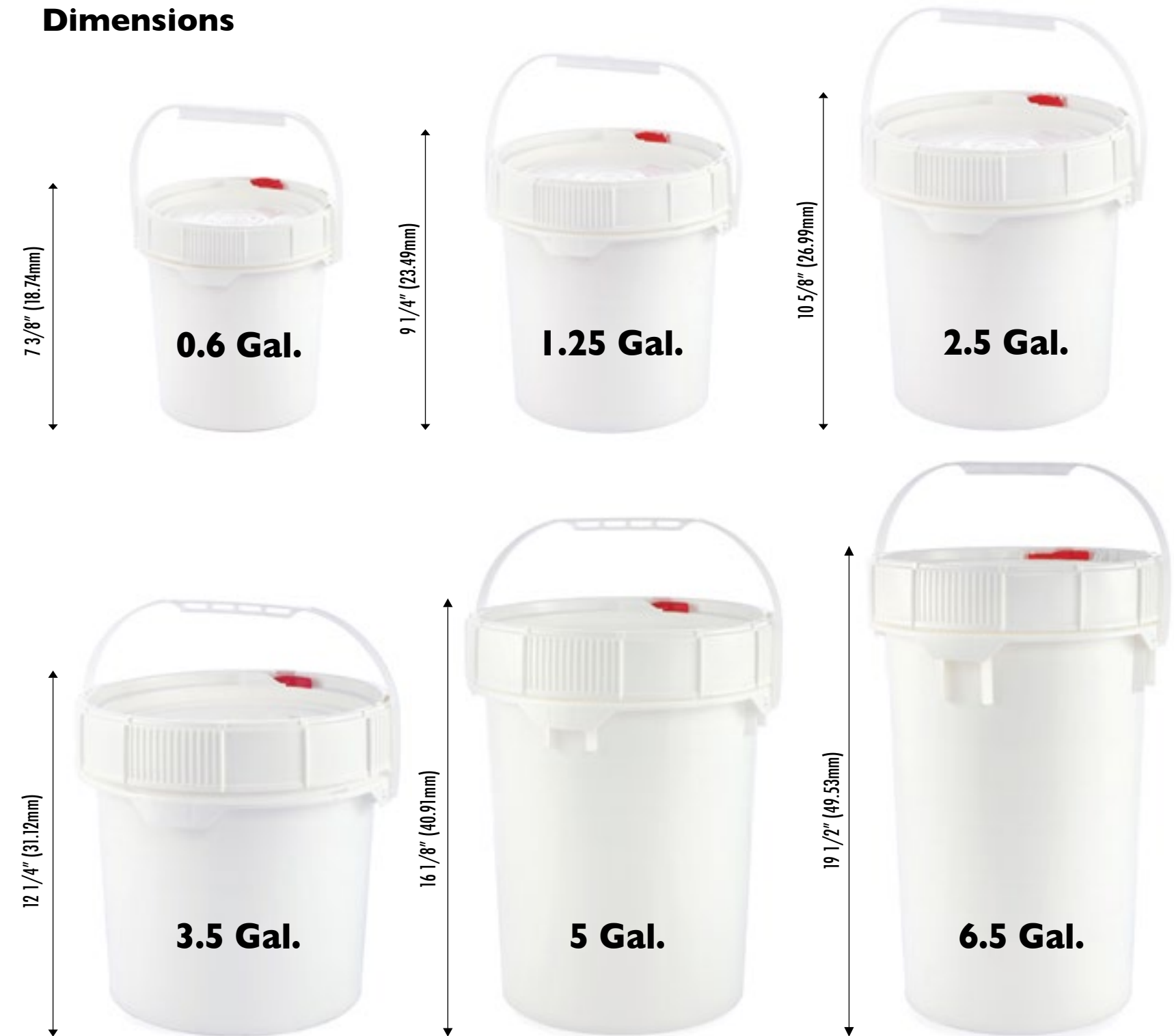

DEHYDRANTS AND CLEARING AGENTS



HIGH PURITY LABORATORY REAGENTS

Reagents • Dehydrants
Xylene and Xylene Substitutes



Acetone

Acetone is used as a cleaning solvent, mounting medium remover, mordant and other multiple laboratory uses.

Item	Volume	Qty
FX2101	Gal. (3.8L)	EA.
CX2101	5 Gal. (19L)	Metal Pail



Compatible
Mounting Mediums
See Pages 175-176

Xylene

Pure filtered and highly refined to deliver consistent performance. Its high solvency ensures rapid and complete de-waxing and clearing. Available in non-breakable solvent-resistant 1 gallon (3.8 L) containers/case of 4 x 1 gallons.

Item	Volume	Qty
XY1004	Gal. (3.8L)	CS/4

Zero Xylene™, Xylene Substitute

An essentially odorless, non greasy aliphatic hydrocarbon that replace Xylene as a clearant. Zero Xylene™ is a gentle, yet effective clearant that will not over-harden specimens and is safe to use in both open and closed tissue processors.

Item	Volume	Qty
XSG1004	Gal. (3.8L)	EA.
XS1004	Gal. (3.8L)	CS/4

Clear-Away Citrus™, Clearing Agent

Clear Away Citrus™ is formulated to replace Xylene and Toluene in Histology and Cytology laboratory procedures. Clear Away Citrus™ is a d-limonene based clearing agent that is biodegradable and miscible with alcohols, paraffins and mounting mediums.

Item	Volume	Qty
FX2180	Gal. (3.8L)	EA.
FX2181	Gal. (3.8L)	CS/4

CitriSolv®, Clearing Agent

CitriSolv® is a d-Limonene-based solvent and clearing agent that can be used as a safe alternative to xylene. (CitriSolv® brand)

Item	Volume	Qty
FX2280CITR	Gal. (3.8L)	CS/4 (32 LBS CS)



Alcohols

100% Reagent Alcohol, 200 Proof

Excellent dehydrant for all Histology and Cytology applications. (200 Proof)

95% Reagent Alcohol, 190 Proof

Excellent dehydrant for all Histology and Cytology applications. (190 Proof)

70% Reagent Alcohol, 140 Proof

Excellent dehydrant for all Histology and Cytology applications. (140 Proof)

80% Reagent Alcohol, 160 Proof

Excellent dehydrant for all Histology and Cytology applications. (160 Proof)

Item	Volume	Qty	Item	Volume	Qty	Item	Volume	Qty	Item	Volume	Qty
AL0100	Gal. (3.8L)	CS/4	AL0095	Gal. (3.8L)	CS/4	AL0070	Gal. (3.8L)	CS/4	AL0080	Gal. (3.8L)	CS/4
AL5100	5 Gallon Cube	EA.	AL5095	5 Gallon Cube	EA.						
AL0055	Drum	EA.									

Alcohols

100% Isopropyl Alcohol

Highest purity and quality standards.

Methyl Alcohol, ACS Reagent

99% absolute. (Methanol), For general tissue processing as a substitute for ethanol or as a cytology fixative.

Item	Volume	Qty	Item	Volume	Qty
FX2100	Gal. (3.8L)	CS/4	MG1004	Gal. (3.8L)	CS/4
FX5210	5 Gallon Cube	EA.			





Pureview® Series Alcohol

Designed to prevent over-dehydration in tissue samples. This formulation is ideal for both large and small specimens.

Pureview® Alcohol 70

Item	Description	Vol.	Qty
PV7000	Pureview® Alcohol 70%	Gal. (3.8L)	CS/4

Pureview® Alcohol 80

Item	Description	Vol.	Qty
PV8000	Pureview® Alcohol 80%	Gal. (3.8L)	CS/4

Pureview® Alcohol 95

Item	Description	Vol.	Qty
PV9500	Pureview® Alcohol 95%	Gal. (3.8L)	CS/4

Pureview® Alcohol 100

Item	Description	Vol.	Qty
PV1000	Pureview® Alcohol 100%	Gal. (3.8L)	CS/4

Using
Richard-Allan Flex™ Alcohols?
Try Pureview® Series



Reduce Errors and Easily Match Reagents to Containers

Color Code Tissue Processor Labels

CDI tissue processor labels are color-coded to match CDI reagent labels. Affix labels to staining reservoirs and/or processor receptacles for easier color-coding of Reagents. Labels provided upon request at time of order.

Item	Description	Qty	Item	Description	Qty
LBL-RL1	Reagent Label 100% Alcohol	EA.	LBL-RL6	Reagent Label Xylene	EA.
LBL-RL2	Reagent Label 95% Alcohol	EA.	LBL-RL7	Reagent Label Deionized Water	EA.
LBL-RL3	Reagent Label 80% Alcohol	EA.	LBL-RL8	Reagent Label (Isopropanol Alcohol 100%)	EA.
LBL-RL4	Reagent Label 70% Alcohol	EA.	LBL-RL9	Reagent Label Plain	EA.
LBL-RL5	Reagent Label 10% NBF	EA.			



CASSETTES AND ACCESSORIES

HISTOLOGY CASSETTES FOR ROUTINE BIOPSY PROCESSING AND EMBEDDING

Routine Cassettes • Biopsy Cassettes
Specialty Cassettes • Cassette Printer Ribbon



Routine Cassettes

CDI routine cassettes come in 11 standard colors for you to choose from (unless otherwise stated). We offer both front and rear tab, with hinge or molded/frangible hinge.

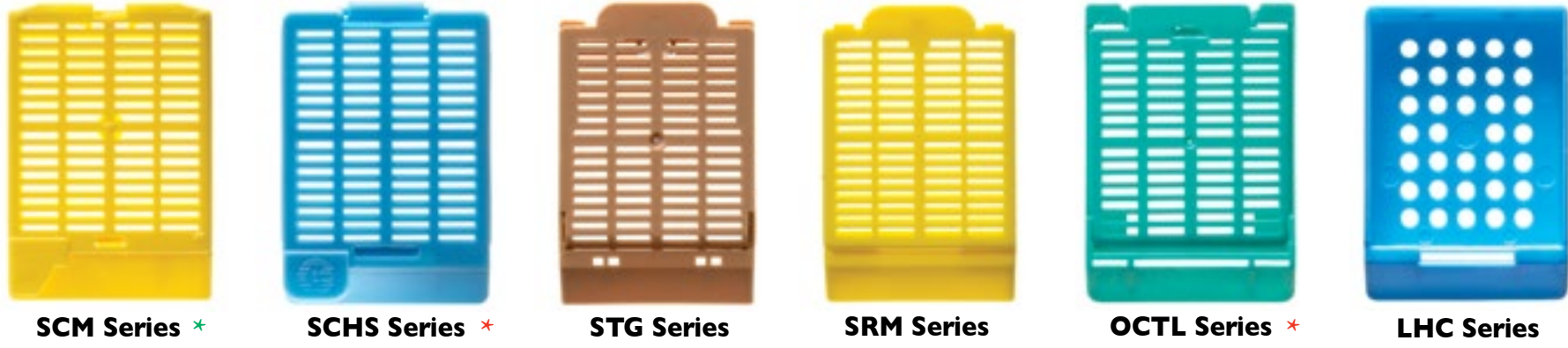

Biopsy Cassettes

CDI biopsy cassettes come in 11 standard colors for you to choose from (unless otherwise stated). We offer both front and rear tab, with hinge or molded/frangible hinge designs. Loose in dispenser boxes, sleeved, or pre-taped for loading onto cassette printers.

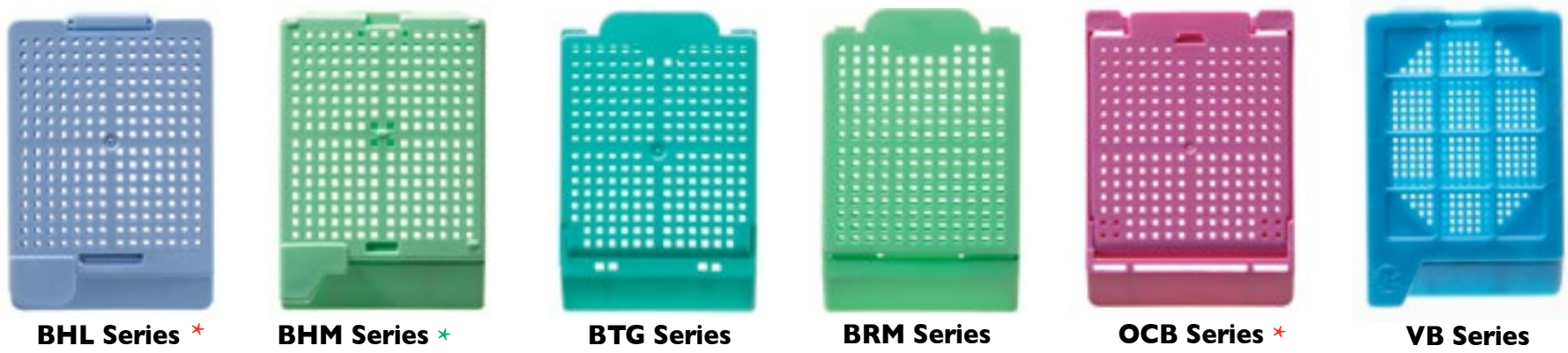

Specialty Cassettes

Keep small biopsy specimens secure. CDI offers specialty cassettes for safe, thorough processing of biopsies. Double deep cassette and large cassettes included in this category.

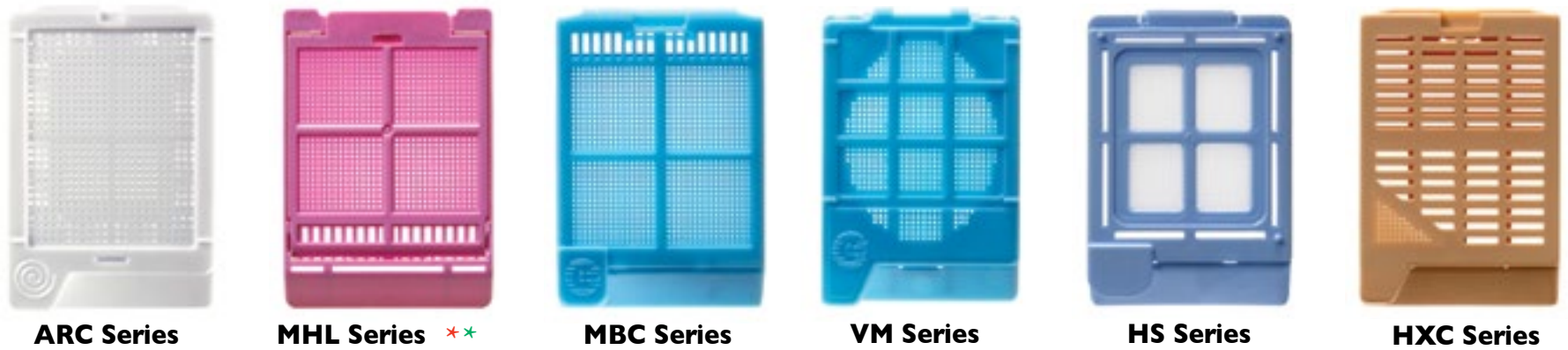

* Available for Laser Printer

* Available for Primera Signature® Printer

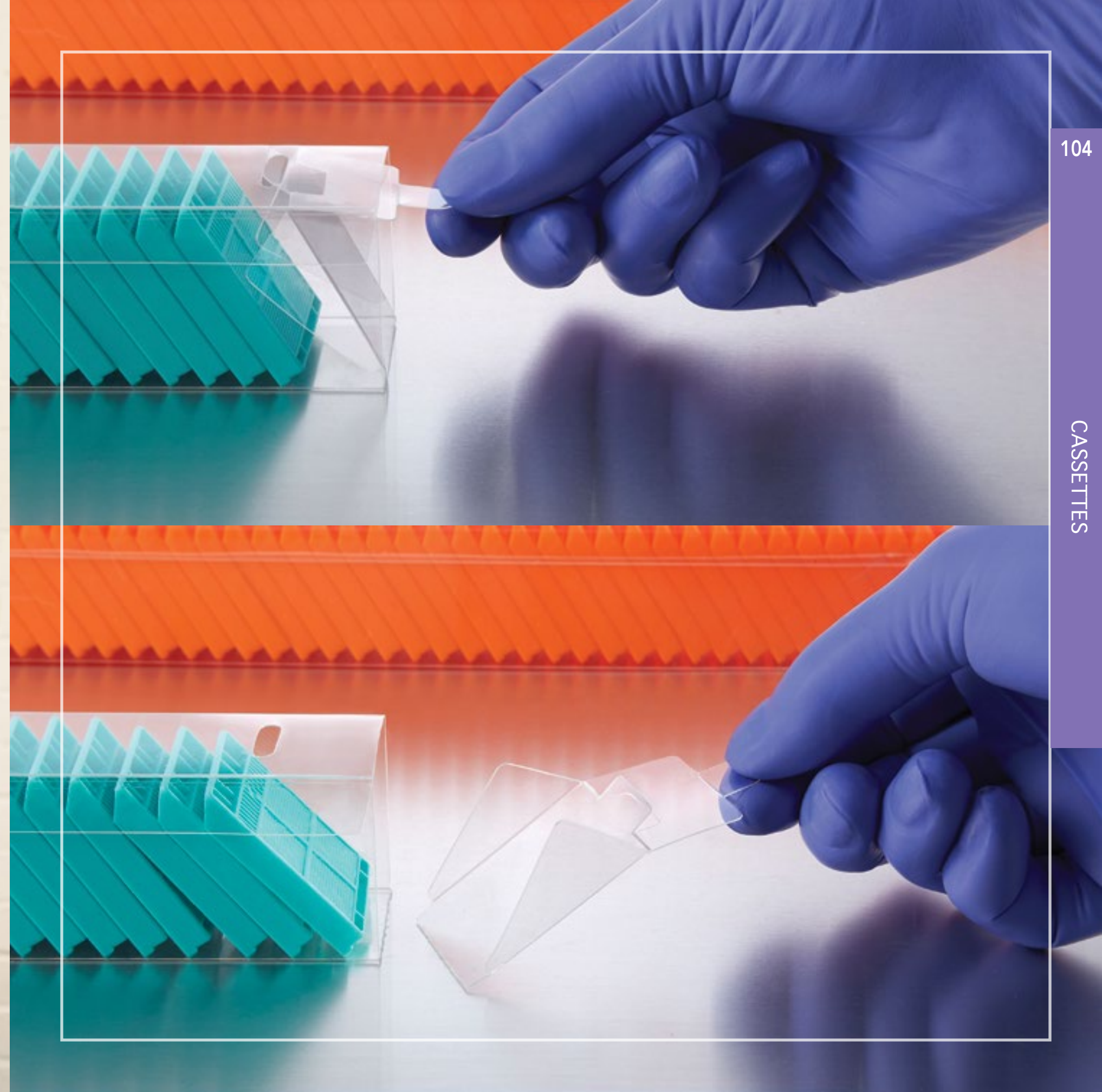

Taped Cassettes



COLOR Coded Packaging

Easily identify cassette colors and continue to work efficiently with CDI's color-coded cassette boxes. Makes storing cassette boxes and locating colors easier with easily identifiable exterior labeling. Taped cassettes optimized for use with Leica and Sakura printers.

Routine Cassettes

One Piece Molded Tissue Slat Cassette

Tissue Slat Cassettes in 14 colors. Optimal writing surface. Excellent adherence for all inks. Optimal polymer technology resistant to all chemicals. Secure and safe.

Color	Loose (CS/1500)	Taped (CS/1000)
White	SCM1000	SCTP1000
Gray	SCM1001	SCTP1001
Blue	SCM1002	SCTP1002
Green	SCM1003	SCTP1003
Pink	SCM1004	SCTP1004
Yellow	SCM1005	SCTP1005
Orange	SCM1006	SCTP1006
Lavender	SCM1007	SCTP1007
Peach	SCM1008	SCTP1008
Aqua	SCM1009	SCTP1009
Tan	SCM1010	SCTP1010
Red (watermelon)	SCM1014	SCTP1014
Gold	SCM1015	SCTP1015
Purple	SCM1017	SCTP1017



35°
Labeling Surface



Hinged Tissue Slat Cassette

Optimal printing and writing surface. Available in Plastic Tube (sleeve), Loose and Taped. Available in 12 colors. Taped cassette bases/lids packed separately.

Color	Loose (CS/1000) (bases & lids packed separately)	Loose (CS/1500) (3 BX/500)	Loose Bulk (CS/2000) Dispenser Boxes (Bases & lids packed separately)	Tubed (CS/750)	Taped (CS/1000) (25 Stacks of 40, taped bases & lids packed separately)
White	SCHS1000	SCHT1000	SCHS1000-BLK	SCSL1000	SHLTP1000
Gray	SCHS1001	SCHT1001	SCHS1001-BLK	SCSL1001	SHLTP1001
Blue	SCHS1002	SCHT1002	SCHS1002-BLK	SCSL1002	SHLTP1002
Green	SCHS1003	SCHT1003	SCHS1003-BLK	SCSL1003	SHLTP1003
Pink	SCHS1004	SCHT1004	SCHS1004-BLK	SCSL1004	SHLTP1004
Yellow	SCHS1005	SCHT1005	SCHS1005-BLK	SCSL1005	SHLTP1005
Orange	SCHS1006	SCHT1006	SCHS1006-BLK	SCSL1006	SHLTP1006
Lavender	SCHS1007	SCHT1007	SCHS1007-BLK	SCSL1007	SHLTP1007
Peach	SCHS1008	SCHT1008	SCHS1008-BLK	SCSL1008	SHLTP1008
Aqua	SCHS1009	SCHT1009	SCHS1009-BLK	SCSL1009	SHLTP1009
Tan	SCHS1010	SCHT1010	SCHS1010-BLK	SCSL1010	SHLTP1010
Red/Melon	SCHS1014	SCHT1014	SCHS1014-BLK	SCSL1014	SHLTP1014

45°
Labeling Surface

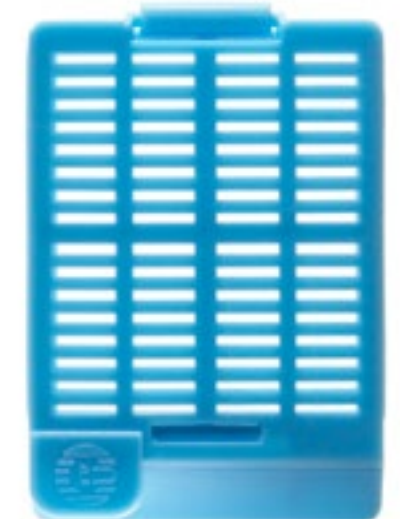

Routine Cassettes

Reverse Hinged Tissue Slat Cassette

Optimal printing surface for all markers and automated instruments.

Color	Loose (CS /1500)	Loose Bulk (CS/2000) Dispenser Boxes (Bases & lids packed separately)	Tubed (CS/750)	Taped (CS /2000)
○ White	STG1000	STG1000-BLK	STGSL1000	STGT1000
○ Gray	STG1001	STG1001-BLK	STGSL1001	STGT1001
● Blue	STG1002	STG1002-BLK	STGSL1002	STGT1002
● Green	STG1003	STG1003-BLK	STGSL1003	STGT1003
● Pink	STG1004	STG1004-BLK	STGSL1004	STGT1004
● Yellow	STG1005	STG1005-BLK	STGSL1005	STGT1005
● Orange	STG1006	STG1006-BLK	STGSL1006	STGT1006
● Lavender	STG1007	STG1007-BLK	STGSL1007	STGT1007
● Peach	STG1008	STG1008-BLK	STGSL1008	STGT1008
● Aqua	STG1009	STG1009-BLK	STGSL1009	STGT1009
● Tan	STG1010	STG1010-BLK	STGSL1010	STGT1010

45°
Labeling
Surface



Reverse, One-Piece, Tissue Slat Cassette

Molded one-piece tissue slat cassette with 30 and 45 degree angle writing surface. The lid is snapped apart and inserted into the base leaving the writing surface "tab-free". Histosette 1 design.

Color	30°	45°
	Loose (CS /1500)	Loose (CS /1500)
○ White	SRM1000-30	SRM1000
○ Gray	SRM1001-30	SRM1001
● Blue	SRM1002-30	SRM1002
● Green	SRM1003-30	SRM1003
● Pink	SRM1004-30	SRM1004
● Yellow	SRM1005-30	SRM1005
● Orange	SRM1006-30	SRM1006
● Lavender	SRM1007-30	SRM1007
● Peach	SRM1008-30	SRM1008
● Aqua	SRM1009-30	SRM1009
● Tan	SRM1010-30	SRM1010

30°
Labeling
Surface

45°
Labeling
Surface

Break Off Hinge



Routine Cassettes

Thinsette™ Reverse Hinged Tissue Slat Cassette

A recessed cover enables these cassettes to be printed with the cover on when used in automated printing instruments.

Color	Loose (CS/1500)	Tubed (CS/750)	Taped (CS/2000)
○ White	OCTL1000	OCCS1000	OSTP1000
○ Gray	OCTL1001	OCCS1001	OSTP1001
● Blue	OCTL1002	OCCS1002	OSTP1002
● Green	OCTL1003	OCCS1003	OSTP1003
● Pink	OCTL1004	OCCS1004	OSTP1004
● Yellow	OCTL1005	OCCS1005	OSTP1005
● Orange	OCTL1006	OCCS1006	OSTP1006
● Lavender	OCTL1007	OCCS1007	OSTP1007
● Peach	OCTL1008	OCCS1008	OSTP1008
● Aqua	OCTL1009	OCCS1009	OSTP1009
● Tan	OCTL1010	OCCS1010	OSTP1010

45°
Labeling
Surface



Round Hole Processing Cassette

11 different stock colors. Custom colors available upon request. Cassettes are used with metal lids.

Color	Loose (CS/1500)	Loose	Tubed (CS/750)	Taped (CS/2000)
		Loose Bulk (CS/2000) Dispenser Boxes		
○ White	LHC1000	LHC1000-BLK	LHC1000-SL	LHC1000-T
○ Gray	LHC1001	LHC1001-BLK	LHC1001-SL	LHC1001-T
● Blue	LHC1002	LHC1002-BLK	LHC1002-SL	LHC1002-T
● Green	LHC1003	LHC1003-BLK	LHC1003-SL	LHC1003-T
● Pink	LHC1004	LHC1004-BLK	LHC1004-SL	LHC1004-T
● Yellow	LHC1005	LHC1005-BLK	LHC1005-SL	LHC1005-T
● Orange	LHC1006	LHC1006-BLK	LHC1006-SL	LHC1006-T
● Lavender	LHC1007	LHC1007-BLK	LHC1007-SL	LHC1007-T
● Peach	LHC1008	LHC1008-BLK	LHC1008-SL	LHC1008-T
● Aqua	LHC1009	LHC1009-BLK	LHC1009-SL	LHC1009-T
● Tan	LHC1010	LHC1010-BLK	LHC1010-SL	LHC1010-T

45°
Labeling
Surface



Item	Description	Qty
LHC9999	Stainless Lid	PK/25

Reusable. For use with LHC Series



Use with metal lids

Biopsy Cassettes

One Piece Molded Biopsy Hole Cassette

Easy optimal writing surface. Excellent adherence for all inks. Optimal polymer technology resistant to all chemicals. Secure and safe. Packaged taped and loose. Taped cassettes optimized for automated cassette printers.

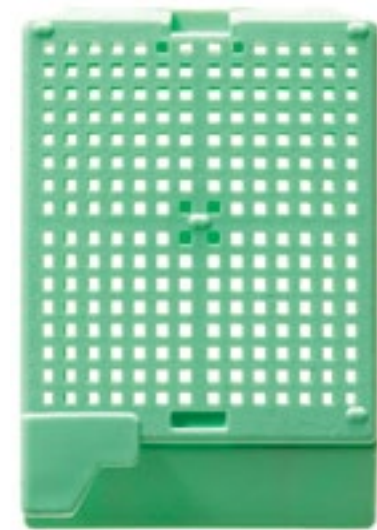

Color	Loose (CS/1500) (3 BX/500)	Taped (CS/1000)
White	BHM1000	BHTP1000
Gray	BHM1001	BHTP1001
Blue	BHM1002	BHTP1002
Green	BHM1003	BHTP1003
Pink	BHM1004	BHTP1004
Yellow	BHM1005	BHTP1005
Orange	BHM1006	BHTP1006
Lavender	BHM1007	BHTP1007
Peach	BHM1008	BHTP1008
Aqua	BHM1009	BHTP1009
Tan	BHM1010	BHTP1010

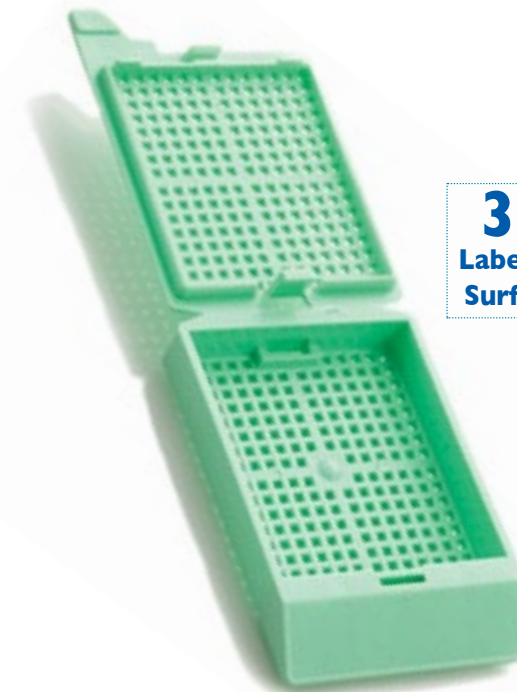

35°
Labeling
Surface

Hinged Biopsy Hole Cassette

Optimal printing and writing surface. Available in plastic tube (sleeve), loose and taped. Available in 11 colors. Taped cassette bases/lids packed separately.

Color	Loose (CS/1000) (bases & lids packed separately)	Loose (CS/1500) (3 BX/500)	Loose Bulk (CS/2000) Dispenser Boxes (Bases & lids packed separately)	Tubed (CS/750)	Taped (CS/1000) (25 Stacks of 40, taped bases & lids packed separately)
White	BCHS1000	BHL1000	BCHS1000-BLK	BHSL1000	BHLTP1000
Gray	BCHS1001	BHL1001	BCHS1001-BLK	BHSL1001	BHLTP1001
Blue	BCHS1002	BHL1002	BCHS1002-BLK	BHSL1002	BHLTP1002
Green	BCHS1003	BHL1003	BCHS1003-BLK	BHSL1003	BHLTP1003
Pink	BCHS1004	BHL1004	BCHS1004-BLK	BHSL1004	BHLTP1004
Yellow	BCHS1005	BHL1005	BCHS1005-BLK	BHSL1005	BHLTP1005
Orange	BCHS1006	BHL1006	BCHS1006-BLK	BHSL1006	BHLTP1006
Lavender	BCHS1007	BHL1007	BCHS1007-BLK	BHSL1007	BHLTP1007
Peach	BCHS1008	BHL1008	BCHS1008-BLK	BHSL1008	BHLTP1008
Aqua	BCHS1009	BHL1009	BCHS1009-BLK	BHSL1009	BHLTP1009
Tan	BCHS1010	BHL1010	BCHS1010-BLK	BHSL1010	BHLTP1010



45°
Labeling
Surface

Biopsy Cassettes

Reverse Hinged Biopsy Hole Cassette

Optimal printing surface for all markers and automated instruments.

Color	Loose (CS/1500)	Loose Bulk (CS/2000) Dispenser Boxes (Bases & lids packed separately)	Tubed (CS/750)	Taped (CS/2000)
White	BTG1000	BTG1000-BLK	BTGSL1000	BTGT1000
Gray	BTG1001	BTG1001-BLK	BTGSL1001	BTGT1001
Blue	BTG1002	BTG1002-BLK	BTGSL1002	BTGT1002
Green	BTG1003	BTG1003-BLK	BTGSL1003	BTGT1003
Pink	BTG1004	BTG1004-BLK	BTGSL1004	BTGT1004
Yellow	BTG1005	BTG1005-BLK	BTGSL1005	BTGT1005
Orange	BTG1006	BTG1006-BLK	BTGSL1006	BTGT1006
Lavender	BTG1007	BTG1007-BLK	BTGSL1007	BTGT1007
Peach	BTG1008	BTG1008-BLK	BTGSL1008	BTGT1008
Aqua	BTG1009	BTG1009-BLK	BTGSL1009	BTGT1009
Tan	BTG1010	BTG1010-BLK	BTGSL1010	BTGT1010

45°
Labeling
Surface

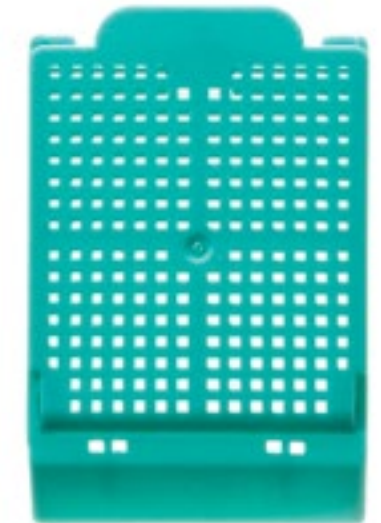

Reverse, One-piece, Biopsy Hole Cassette

Molded one-piece biopsy hole cassette with 30 and 45 degree angle writing surface. The lid is snapped apart and inserted into the base leaving the writing surface "tab-free". Histosette 1 design. Not suitable for automated printers.

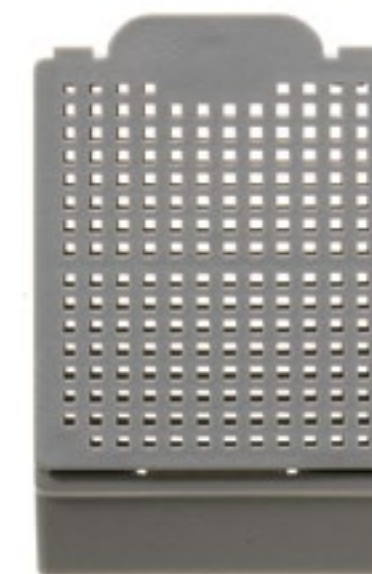

Color	30° Loose (CS/1500)	45° Loose (CS/1500)
White	BRM1000-30	BRM1000
Gray	BRM1001-30	BRM1001
Blue	BRM1002-30	BRM1002
Green	BRM1003-30	BRM1003
Pink	BRM1004-30	BRM1004
Yellow	BRM1005-30	BRM1005
Orange	BRM1006-30	BRM1006
Lavender	BRM1007-30	BRM1007
Peach	BRM1008-30	BRM1008
Aqua	BRM1009-30	BRM1009
Tan	BRM1010-30	BRM1010

Molded Hinge

30°
Labeling
Surface

45°
Labeling
Surface

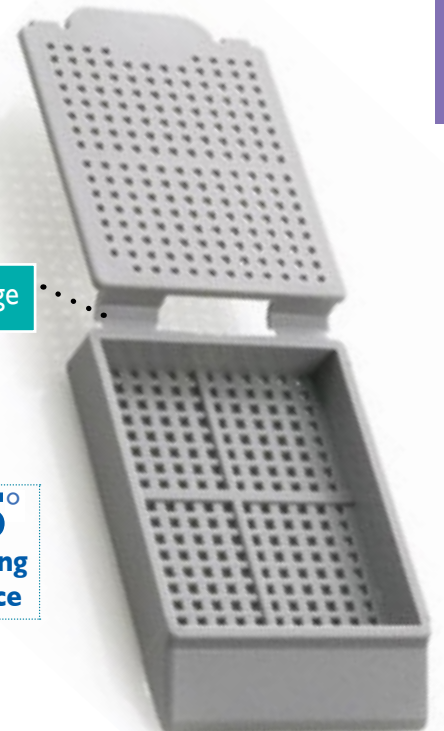

Biopsy Cassettes

Thinsette™ Reverse Hinged Biopsy Hole Cassette

A recessed cover enables these cassettes to be printed with the cover on when used in automated printing instruments. The thin design also provides for greater storage capacity.

Color	Loose (CS/1500)	Tubed (CS/750)	Taped (CS/2000)
○ White	OCB1000	OPCS1000	OCTP1000
○ Gray	OCB1001	OPCS1001	OCTP1001
● Blue	OCB1002	OPCS1002	OCTP1002
● Green	OCB1003	OPCS1003	OCTP1003
● Pink	OCB1004	OPCS1004	OCTP1004
● Yellow	OCB1005	OPCS1005	OCTP1005
● Orange	OCB1006	OPCS1006	OCTP1006
● Lavender	OCB1007	OPCS1007	OCTP1007
● Peach	OCB1008	OPCS1008	OCTP1008
● Aqua	OCB1009	OPCS1009	OCTP1009
● Tan	OCB1010	OPCS1010	OCTP1010



Vortex™ Biopsy Cassette

Small biopsy cassette. One-Piece frangible lid design. Rounded interior has no corners like traditional cassettes. Biopsies are easy to find after processing. Side-vents designed for enhanced infiltration.

Can be used with oval biopsy papers see Page 49

Color	Loose (CS/1000)	Taped (CS/1000)
○ White	VB1000	VBT1000
○ Gray	VB1001	VBT1001
● Blue	VB1002	VBT1002
● Green	VB1003	VBT1003
● Pink	VB1004	VBT1004
● Yellow	VB1005	VBT1005
● Orange	VB1006	VBT1006
● Lavender	VB1007	VBT1007
● Peach	VB1008	VBT1008
● Aqua	VB1009	VBT1009
● Tan	VB1010	VBT1010
● Red (watermelon)	VB1014	VBT1014
● Gold	VB1015	VBT1015
● Purple	VB1017	VBT1017

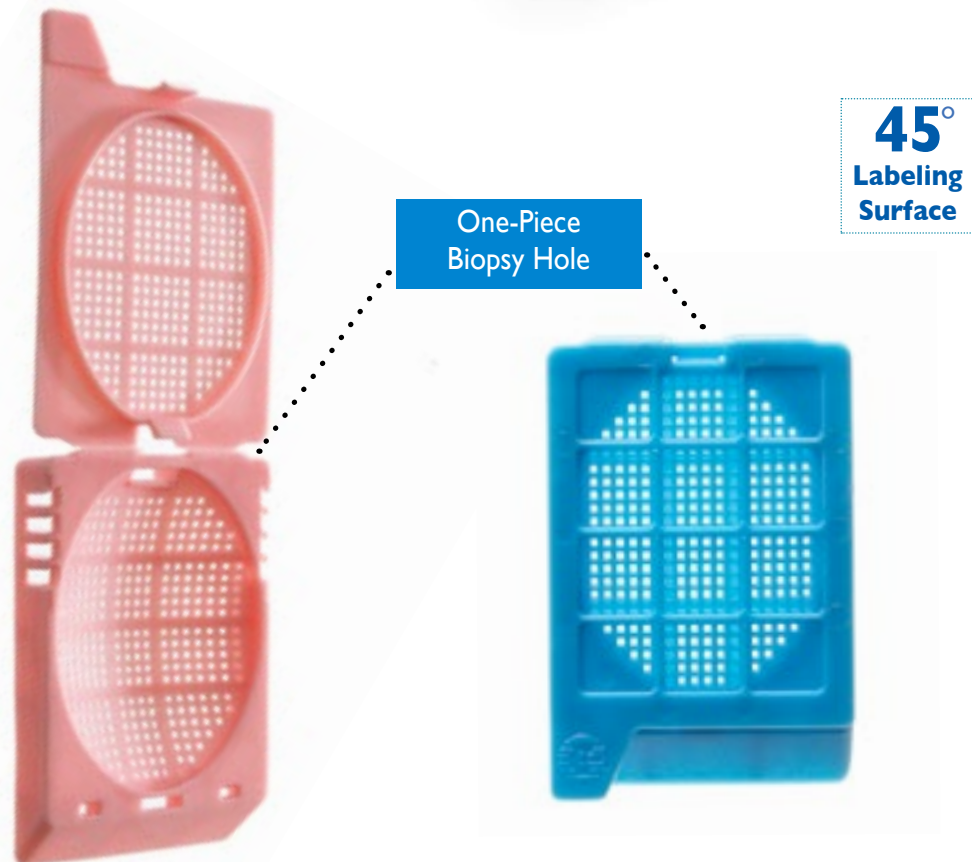

Specialty Cassettes

ARCHIMEDES Series Cassettes

Curved cassette walls produce basket interior with zero corners. Side-wall directional micro-holes provide for better fluid transfer and biopsy processing while decreasing fluid pressure and buoyancy.



Color	Loose (CS/1000)	Taped (CS/1000)
○ White	ARC1000	ARCT1000
● Blue	ARC1002	ARCT1002
● Green	ARC1003	ARCT1003
● Pink	ARC1004	ARCT1004
● Yellow	ARC1005	ARCT1005

45°
Labeling
Surface

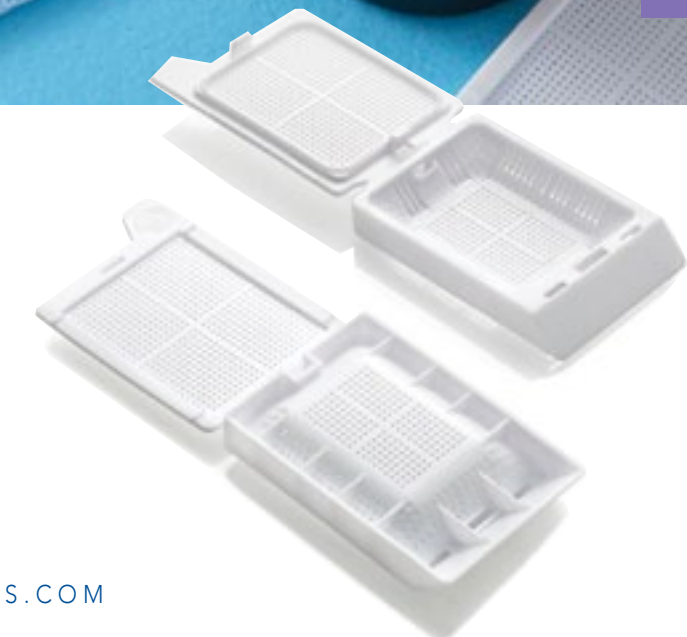

Specialty Cassettes

Biopsy Hinged Micro Cassette

Molded mesh for ultimate biopsy security. Molded for optimal surface tension. Allows for complete processing.



Color	Loose (CS /1000) (Dispenser boxes)	Tubed (CS /750)	Taped (CS /2000) (50 Stacks of 40 cassettes)
○ White	MHL1000	MHS1000	MHT1000
○ Gray	MHL1001	MHS1001	MHT1001
● Blue	MHL1002	MHS1002	MHT1002
● Green	MHL1003	MHS1003	MHT1003
● Pink	MHL1004	MHS1004	MHT1004
● Yellow	MHL1005	MHS1005	MHT1005
● Orange	MHL1006	MHS1006	MHT1006
● Lavender	MHL1007	MHS1007	MHT1007
● Peach	MHL1008	MHS1008	MHT1008
● Aqua	MHL1009	MHS1009	MHT1009
● Tan	MHL1010	MHS1010	MHT1010



45°
Labeling
Surface

Biopsy Micro One-Piece Cassette

One-piece molded (.3mm) hole microbiopsy cassette contains even the tiniest biopsies including bone marrow biopsies. Textured writing surface for today's printers and markers.

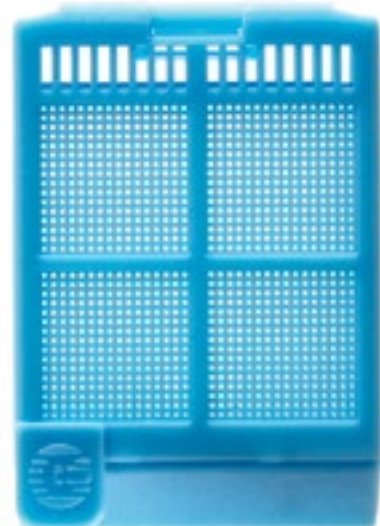

Color	Loose (CS/1000)	Taped (CS/1000)
○ White	MBC1000	MBCT1000
○ Gray	MBC1001	MBCT1001
● Blue	MBC1002	MBCT1002
● Green	MBC1003	MBCT1003
● Pink	MBC1004	MBCT1004
● Yellow	MBC1005	MBCT1005
● Orange	MBC1006	MBCT1006
● Lavender	MBC1007	MBCT1007
● Peach	MBC1008	MBCT1008
● Aqua	MBC1009	MBCT1009
● Tan	MBC1010	MBCT1010
● Red (watermelon)	MBC1014	MBCT1014
● Gold	MBC1015	MBCT1015
● Purple	MBC1017	MBCT1017



45°
Labeling
Surface

Specialty Cassettes

Mesh Screen Cassette

A unique inner chamber lined with 'see-through' mesh for easy identification and specimen security. Designed to replace sponges, bags and paper while keeping biopsy safe for processing. Thermo version available (Use item number without - CDI)

Color	Loose (CS/250)	Tubed (CS/750)
○ White	HS2500-CDI	HSSL2500-CDI
○ Gray	HS2501-CDI	HSSL2501-CDI
● Blue	HS2502-CDI	HSSL2502-CDI
● Green	HS2503-CDI	HSSL2503-CDI
● Pink	HS2504-CDI	HSSL2504-CDI
● Yellow	HS2505-CDI	HSSL2505-CDI
● Orange	HS2506-CDI	HSSL2506-CDI
● Lavender	HS2507-CDI	HSSL2507-CDI
● Aqua	HS2509-CDI	HSSL2509-CDI
● Tan	HS2510-CDI	HSSL2510-CDI
● Red	HS2511-CDI	HSSL2511-CDI



45°
Labeling
Surface



Vortex™ Micro Cassette

Small biopsy cassette. Rounded Micro-Hole interior basket has no corners like traditional cassettes. Biopsies are easy to find after processing. Side-Vents designed for enhanced infiltration.

Color	Loose (CS/1000)
○ White	VM1000
○ Gray	VM1001
● Blue	VM1002
● Green	VM1003
● Pink	VM1004
● Yellow	VM1005
● Orange	VM1006
● Lavender	VM1007
● Peach	VM1008
● Aqua	VM1009
● Tan	VM1010
● Red (watermelon)	VM1014
● Gold	VM1015
● Purple	VM1017

Hinged
Micro-Hole

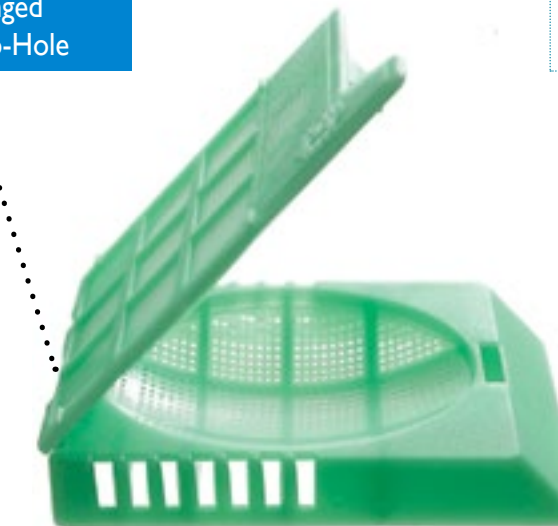

45°
Labeling
Surface



Specialty Cassettes

Corner Mesh (Hybrid Cassette)

Regular one-piece tissue slat molded hinge cassette, with mesh corner for small biopsies. Corner is fully contained for ultimate biopsy security. Use corner when needed, use main body for larger specimens.

Color	Loose (CS/1500)
White	HXC1000
Gray	HXC1001
Blue	HXC1002
Green	HXC1003
Pink	HXC1004
Yellow	HXC1005
Orange	HXC1006
Lavender	HXC1007
Peach	HXC1008
Aqua	HXC1009
Tan	HXC1010
Dk Green	HXC1013
Red	HXC1014

45°
Labeling Surface

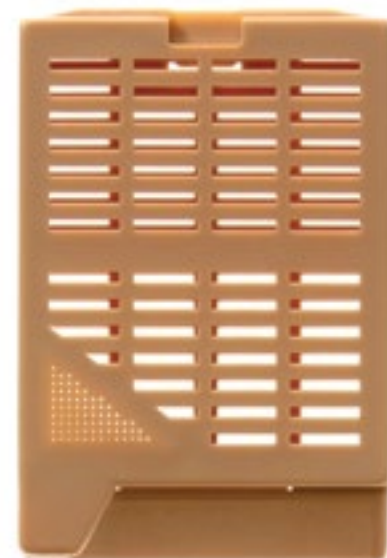

45°
Labeling Surface



Double Deep Cassette

They are twice the depth of the regular cassette, suitable for large specimens.

Color	Loose (CS/750)
White	DDC1000

Disposable Plastic Base Mold (for Double Deep Cassettes)

Item	Description	Qty
M475-10	37mm x 24mm x 10mm	CS/500

Metal Base Mold (for Double Deep Cassettes)

Item	Description	Qty
MBM3724-XL	37mm x 24mm x 10mm	CS/12

Specialty Cassettes

Large Processing Cassette

Large Research Processing Cassette for sectioning large specimens.

Color	Loose (CS/100)
White	LPC1000
Gray	LPC1001
Blue	LPC1002
Green	LPC1003
Pink	LPC1004
Yellow	LPC1005
Orange	LPC1006
Peach	LPC1008
Red	LPC1014



Stainless Steel Base Molds, Reusable Heavy Duty (for Super Large Cassettes)

Item	Description	Qty
LBM3636	36mm x 36mm x 10mm	PK/5
LBM6045	60mm x 45mm x 15mm	PK/5



Disposable Plastic Base Molds (for Super Large Cassettes)

Offset Mold optimized for rotary microtomes

Item	Description	Qty
LBM5550-P	55mm x 50mm	CS/100



Specialty Cassettes

Large Processing Cassette with insert

Designed for use with automated printers. Use standard printed cassette and insert into Large Cassette. Accurate tracking of patient information and no more handwriting. Available in 8 colors - white, gray, blue, green, pink, yellow, orange and red.



Color	Loose (CS/100)
○ White	KLPC1000
● Blue	KLPC1002
● Green	KLPC1003
● Pink	KLPC1004
● Yellow	KLPC1005
● Red	KLPC1014

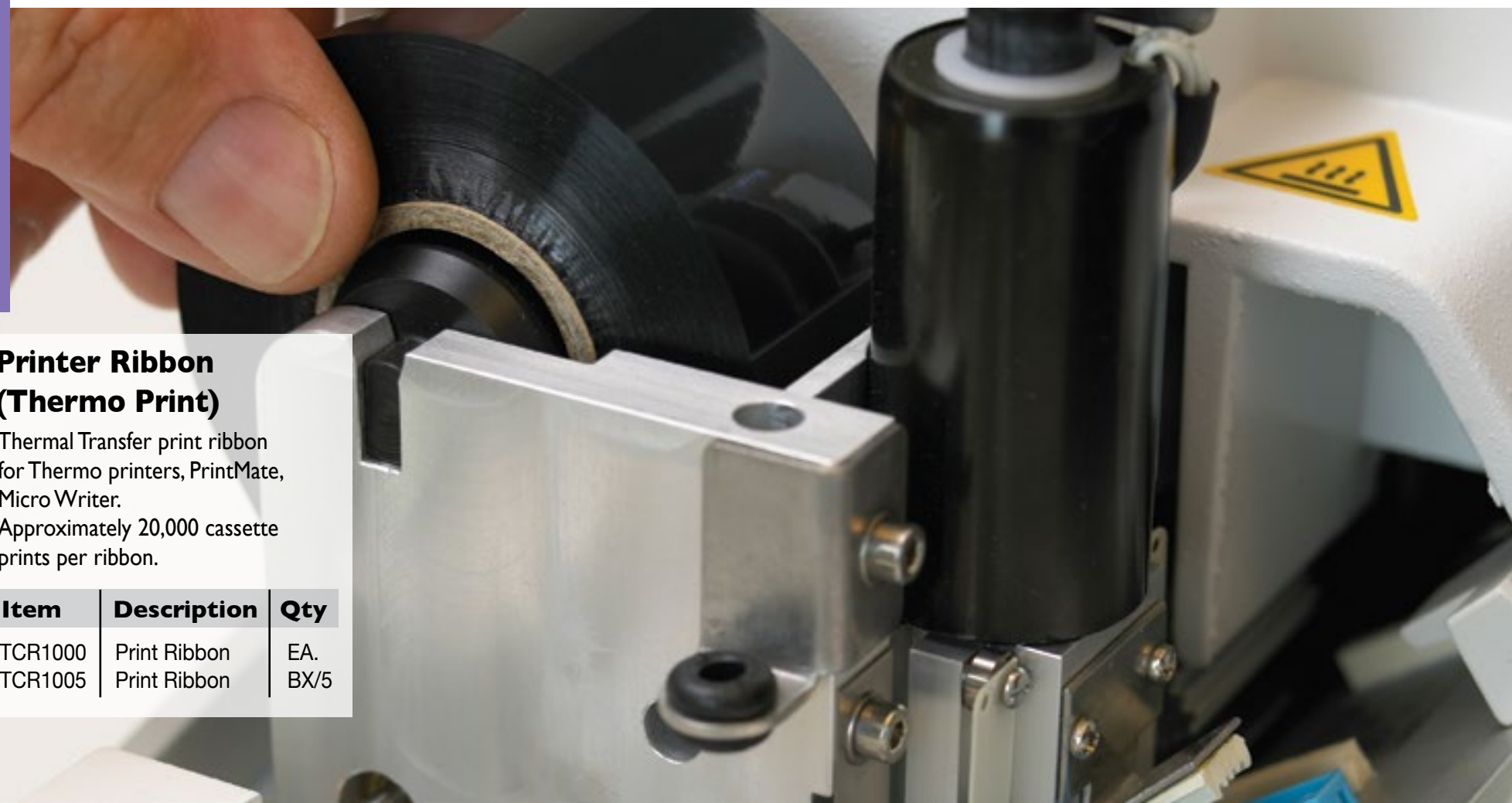

Printer Ribbon (Thermo Print)

Thermal Transfer print ribbon for Thermo printers, PrintMate, Micro Writer. Approximately 20,000 cassette prints per ribbon.

Item	Description	Qty
TCR1000	Print Ribbon	EA.
TCR1005	Print Ribbon	BX/5

Primera Signature® Printer Compatible Cassettes

Tissue Slat Cassette

Routine tissue slat cassette optimized for printing with the Primera Signature® printer and the Tissue-Tek® SmartWrite® automated cassette printers.



Color	Loose (CS/1500)	Taped (CS/1000)
○ White	CDI-M405-2	CDI-M405-2T
● Pink	CDI-M405-3	CDI-M405-3T
● Green	CDI-M405-4	CDI-M405-4T
● Yellow	CDI-M405-5	CDI-M405-5T
● Blue	CDI-M405-6	CDI-M405-6T
● Peach	CDI-M405-7	CDI-M405-7T
● Tan	CDI-M405-8	CDI-M405-8T
● Gray	CDI-M405-9	CDI-M405-9T
● Lavender	CDI-M405-10	CDI-M405-10T
● Orange	CDI-M405-11	CDI-M405-11T
● Aqua	CDI-M405-12	CDI-M405-12T

Biopsy Hole Cassette

Routine Biopsy Hole cassette optimized for printing with the Primera Signature® printer and the Tissue-Tek® SmartWrite® automated cassette printers.



Color	Loose (CS/1500)	Taped (CS/1000)
○ White	CDI-M406-2	CDI-M406-2T
● Pink	CDI-M406-3	CDI-M406-3T
● Green	CDI-M406-4	CDI-M406-4T
● Yellow	CDI-M406-5	CDI-M406-5T
● Blue	CDI-M406-6	CDI-M406-6T
● Peach	CDI-M406-7	CDI-M406-7T
● Tan	CDI-M406-8	CDI-M406-8T
● Gray	CDI-M406-9	CDI-M406-9T
● Lavender	CDI-M406-10	CDI-M406-10T
● Orange	CDI-M406-11	CDI-M406-11T
● Aqua	CDI-M406-12	CDI-M406-12T

Micromesh biopsy hinged cassette

MicroMesh biopsy cassette optimized for printing with the Primera Signature® printer and the Tissue-Tek® SmartWrite® automated cassette printers.



Color	Loose (CS/1000)	Taped (CS/2000)
○ White	CDI-M407-2	CDI-M407-2T
● Pink	CDI-M407-3	CDI-M407-3T
● Green	CDI-M407-4	CDI-M407-4T
● Yellow	CDI-M407-5	CDI-M407-5T
● Blue	CDI-M407-6	CDI-M407-6T
● Peach	CDI-M407-7	CDI-M407-7T
● Tan	CDI-M407-8	CDI-M407-8T
● Gray	CDI-M407-9	CDI-M407-9T
● Lavender	CDI-M407-10	CDI-M407-10T
● Orange	CDI-M407-11	CDI-M407-11T
● Aqua	CDI-M407-12	CDI-M407-12T

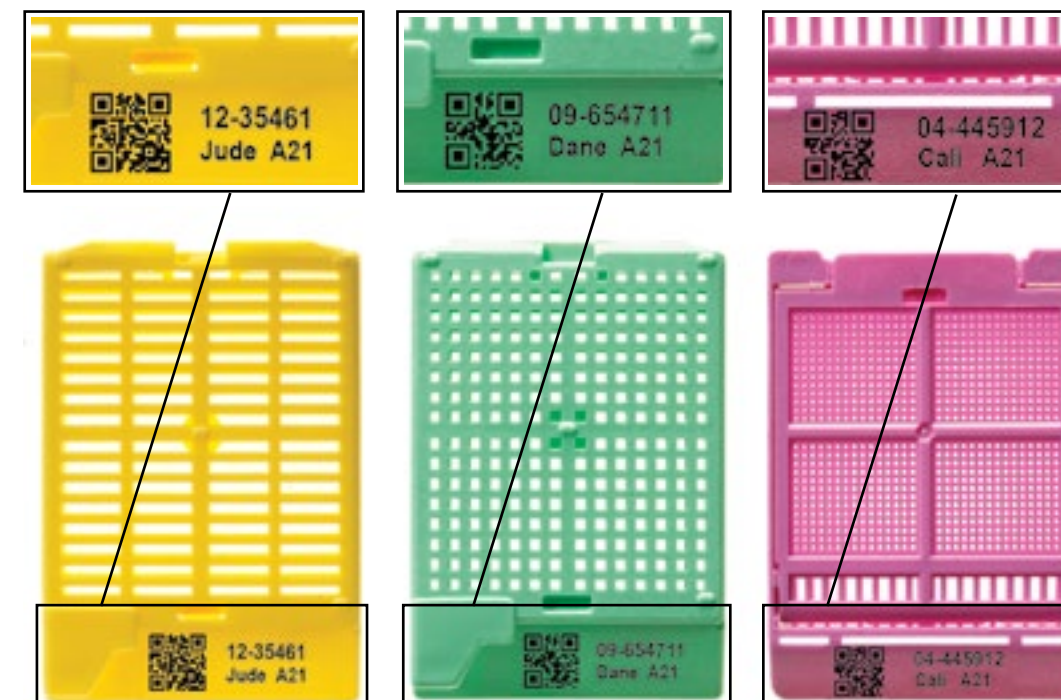



Using General Data LaserTrack™ PHI, PH6 or PH8 Laser Cassette Printer or Fa-Tech Nova™ or Pulsar™ Laser Printer? * Try LaserCassettes™

*LaserTrack™ is ™ of General Data Healthcare, Inc. All rights reserved. Nova™ & Pulsar™ are ™ of Fa-Tech Diagnostics Europe BV

Laser Printer Compatible Cassettes

Laser Cassettes™ contain a special additive that enables laser printing on select industry laser instruments. Highest resolution barcode and text marking is permanent and survives the harshest of histology processes. (not to be used on printers that require black polymer coated cassette face)

Thinsette™ Reverse Hinged Tissue Slat Cassette

A recessed cover enables these cassettes to be printed with the cover on.

Color	Taped (CS/2000)
○ White	LZR-OSTP1000
○ Gray	LZR-OSTP1001
● Blue	LZR-OSTP1002
● Green	LZR-OSTP1003
● Pink	LZR-OSTP1004
● Yellow	LZR-OSTP1005
● Orange	LZR-OSTP1006
● Lavender	LZR-OSTP1007
● Peach	LZR-OSTP1008
● Aqua	LZR-OSTP1009
● Tan	LZR-OSTP1010



Thinsette™ Reverse Hinged Biopsy Hole Cassette

A recessed cover enables these cassettes to be printed with the cover on. The Thin design also provides for greater storage capacity.

Color	Taped (CS/2000)
○ White	LZR-OCTP1000
○ Gray	LZR-OCTP1001
● Blue	LZR-OCTP1002
● Green	LZR-OCTP1003
● Pink	LZR-OCTP1004
● Yellow	LZR-OCTP1005
● Orange	LZR-OCTP1006
● Lavender	LZR-OCTP1007
● Peach	LZR-OCTP1008
● Aqua	LZR-OCTP1009
● Tan	LZR-OCTP1010



Micromesh biopsy hinged cassette

Molded mesh for ultimate biopsy security. Molded for optimal surface tension. Allows for complete processing.

Color	Taped (CS/2000)
○ White	LZR-MHT1000
○ Gray	LZR-MHT1001
● Blue	LZR-MHT1002
● Green	LZR-MHT1003
● Pink	LZR-MHT1004
● Yellow	LZR-MHT1005
● Orange	LZR-MHT1006
● Lavender	LZR-MHT1007
● Peach	LZR-MHT1008
● Aqua	LZR-MHT1009
● Tan	LZR-MHT1010



Hinged Biopsy Hole Cassette

Taped cassette bases/lids packed separately.

Color	Taped (CS/1000)
○ White	LZR-BHLTP1000
○ Gray	LZR-BHLTP1001
● Blue	LZR-BHLTP1002
● Green	LZR-BHLTP1003
● Pink	LZR-BHLTP1004
● Yellow	LZR-BHLTP1005
● Orange	LZR-BHLTP1006
● Lavender	LZR-BHLTP1007
● Peach	LZR-BHLTP1008
● Aqua	LZR-BHLTP1009
● Tan	LZR-BHLTP1010



Hinged Tissue Slat Cassette

Taped cassette bases/lids packed separately.

Color	Taped (CS/1000)
○ White	LZR-SHLTP1000
○ Gray	LZR-SHLTP1001
● Blue	LZR-SHLTP1002
● Green	LZR-SHLTP1003
● Pink	LZR-SHLTP1004
● Yellow	LZR-SHLTP1005
● Orange	LZR-SHLTP1006
● Lavender	LZR-SHLTP1007
● Peach	LZR-SHLTP1008
● Aqua	LZR-SHLTP1009
● Tan	LZR-SHLTP1010
● Red/Melon	LZR-SHLTP1014





EMBEDDING SECTIONING MICROTOMY



EFFICIENT SPECIMEN PROCESSING

Paraffin • Microtome Blades
Embedding & Sectioning Accessories • Frozen Sectioning

KATANA Microtome Blades

Katana™ Microtome Blades are produced using proprietary rolling heat treatment technologies refined from generations of Japanese blade production, including finely controlling carbon grain size and continuous austenite measurements. They are surface-modified coated blades with excellent hardness, wear resistance and sharpness.

Available exclusively through Cancer Diagnostics, Inc., USA



Made in Japan

Professional blades for histological cutting



LOW PROFILE

HIGH PROFILE



Item	Description	Qty
KLP050	Dispenser pack	PK/50
KLP500	10 BX/50	CS/500

Item	Description	Qty
KHP050	Dispenser pack	PK/50
KHP500	10 BX/50	CS/500



bevel® Series Blades

The bevel® family of blades consists of microtome blades from the USA, Japan, and Germany. Each bevel® HD, bevel® Plus, bevel® series, bevel® red, green & black blade undergoes a distinctive coating and polishing process that ensures optimal cutting performance to produce consistent results in the most demanding environments.

Unique coating for durability and consistency. Bevel Gold edge version is optimized for cutting dense and harder tissue.	bevel® Series and bevel® Gold Edge Series	L
Unique coating for durability and consistency. Bevel Gold edge version is optimized for cutting dense and harder tissue.	bevel® Series and bevel® Gold Edge Series	H
Specialized coating for less friction and curling during sectioning. Optimal sharpness for both hard and soft tissues. Japan.	bevel® HD series	L H
Proprietary coating & sharpening process produces enhanced cutting and durability. Japan.	bevel® Plus series	L
Manufactured from high carbon stainless steel for consistent ribboning. PTFE coated.	bevel® green	L
Heavier gauge steel with optimal coating that reduces vibration during cutting.	bevel® red	H
High quality hardened stainless steel blade for routine sectioning & facing.	bevel® black	H

L LOW PROFILE **H** HIGH PROFILE

bevel® blades

Consistent Performance. Reliable Results

- A bevel® Plus Series**
- B bevel® HD Series**
- C bevel® HD Series**
- D bevel® Series**
- E bevel® Series**
- F bevel® Green**
- G bevel® Red**
- H bevel® Black**

bevel® Series



Low Profile Blade



Low Profile Gold Edge Blade



High Profile Blade



High Profile Gold Edge Blade

bevel® High and Low Profile Coated Microtome Blades

(bevel®) Brand Low and High Profile Premium Coated Microtome Blades. (USA). Coated stainless blades.

Gold Edge. Great for cutting skin and harder tissue.

The finely honed cutting edge is triple layered/angled and coated. These processes improve cutting performance and enhance the overall durability of the blade.

Low Profile Blade:

Item	Description	Qty
LPC050	Dispenser pack	BX/50
LPC500	10 BX/50	CS/500

Low Profile Gold Edge Blade:

Item	Description	Qty
LPC050-GL	Dispenser pack	BX/50
LPC500-GL	10 BX/50	CS/500

High Profile Blade:

Item	Description	Qty
HPC050	Dispenser pack	BX/50
HPC500	10 BX/50	CS/500

High Profile Gold Edge Blade:

Item	Description	Qty
HPC050-GL	Dispenser pack	BX/50
HPC500-GL	10 BX/50	CS/500



bevel® HD blades

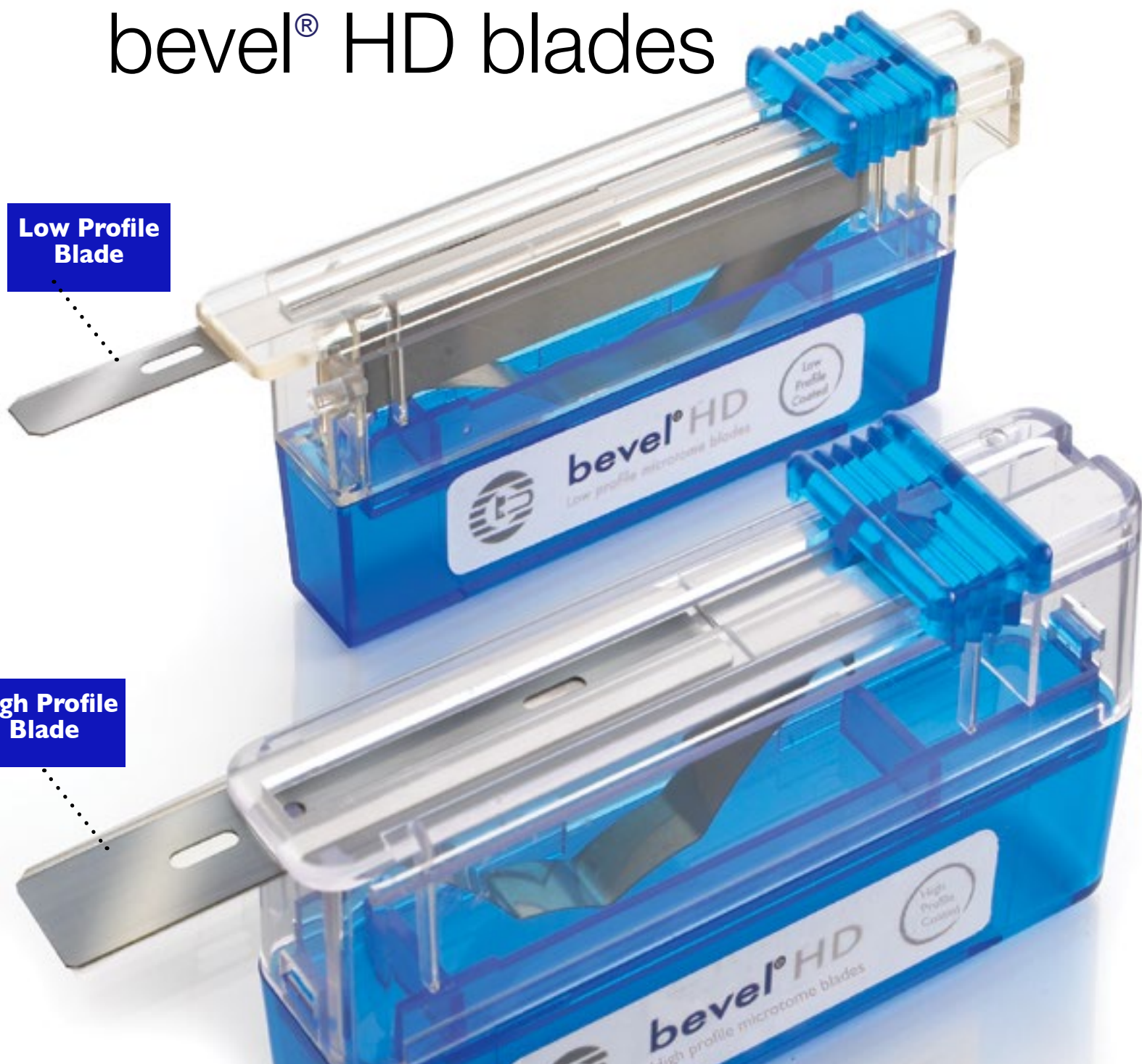

bevel® HD Low Profile Coated Microtome Blades

Dispenser packs of 50.
Case of 500 sold in master pack of 10 boxes of 50.

Sample packs available.

Item	Description	Qty
LPJ3580	Dispenser pack	BX/50
LPJ9999	10 Boxes of 50	CS/500

bevel® HD High Profile Coated Microtome Blades

Dispenser packs of 50.
Case of 500 sold in master pack of 10 boxes of 50.

Item	Description	Qty
HPJ3576	Dispenser pack	BX/50
HPJ9999	10 Boxes of 50	CS/500



bevel® + PLUS Low Profile Coated Microtome Blades

Proprietary coating and sharpening process produces enhanced cutting and durability with a greater sweet-spot for consistent ribboning. Ask for a sample today.

Item	Description	Qty
LPJ3581	Bevel@PLUS	BX/50
LPJ9998	Bevel@PLUS	CS/500



bevel® Red, Green and Black Blades



bevel® RED, GREEN, BLACK High and Low Profile Microtome Blades

bevel GREEN Low Profile Coated Blades
 Manufactured from high carbon stainless steel for consistent ribboning. Tight quality control tolerances ensure the finest honed blades. Triple Edge.

bevel RED High Profile Coated Blades
 A heavier gauge steel with optimal coating that reduces vibration even when cutting through extremely tough tissue.

bevel BLACK High Profile Blade
 High quality blade for routine sectioning and facing.

Item	Description	Qty
LPG050	Green Low Profile Blade	BX/50
LPG500	Green Low Profile Blade	CS/500
HPR050	Red High Profile Blade	BX/50
HPR500	Red High Profile Blade	CS/500
HPB050	Black High Profile Thin	BX/50
HPB500	Black High Profile Thin	CS/500

Microtome Blades

Sturkey Infinity Microtome Blades

INFINITY features a triple faceted, 35 degree cutting edge with 80mm blade length.



Sturkey Box Packaging



Sturkey Extremus Bulk Dispenser



Sturkey Silver Microtome Blades



Extremus Low Profile

Item	Description	Qty
DT315X	Box Packaging	BX/170
DT315XD	Bulk Dispenser	BX/200
DT315X50	Standard Dispenser	BX/50

Silver Low Profile

Item	Description	Qty
DT315R	Box Packaging	BX/170
DT315RD	Bulk Dispenser	BX/200
DT315R50	Standard Dispenser	BX/50

Select Low Profile

Item	Description	Qty
DT315S50	Standard Dispenser	BX/50

Infinity Low Profile

Item	Description	Qty
DT315N50	Standard Dispenser	BX/50

Extremus High Profile

Item	Description	Qty
D554X	Box Packaging	BX/100
D554XD	Bulk Dispenser	BX/120
D554X50	Standard Dispenser	BX/50

Silver High Profile

Item	Description	Qty
D554R	Box Packaging	BX/100
D554RD	Bulk Dispenser	BX/120
D554R50	Standard Dispenser	BX/50

Select High Profile

Item	Description	Qty
DT554S50	Standard Dispenser	BX/50

Infinity High Profile

Item	Description	Qty
DT554N50	Standard Dispenser	BX/50



Accu-Edge® (Feather) Disposable Microtome Blades

The ultra-precision edge of these disposable microtome blades is specially coated for superior cutting performance. Manufactured for thin sectioning of paraffin embedded tissue blocks. These blades have earned a high reputation for superior cutting performance and durability.

Item	Description	Qty
CDI9117-BX	Low Profile Blade	BX/50
CDI9117	Low Profile Blade	CS/500
CDI9118-BX	High Profile Blade	BX/50
CDI9118	High Profile Blade	CS/500



Encore® Microtome Blades

Encore blades are manufactured with precise edge geometry and thickness (.010")

Item	Description	Qty
7380	Low Profile Blade	BX/50
7380-CS	Low Profile Blade	CS/500
7390	High Profile Blade	BX/50
7390-CS	High Profile Blade	CS/500

HP35 and MX35 Series Microtome Blades Thermo



Item	Description	Qty
High Profile		
CDI-3150734	Thermo HP35 Coated Blade	PK/50
CDI-3152735	Thermo HP35N Ultra Non-Coated Blade	PK/50
HPC050-XL	Thermo HP35 Ultra Blade	PK/50
HPC500-XL	Thermo HP35 Ultra Blade	CS/500
Low Profile		
LPC050-P	Thermo MX35 Premier Blade	PK/50
LPC500-P	Thermo MX35 Premier Blade	CS/500
LPC050-PR	Thermo MX35 Premier Plus Blade	PK/50
LPC500-PR	Thermo MX35 Premier Plus Blade	CS/500
LPC050-XL	Thermo MX35 Ultra Blade	PK/50
LPC500-XL	Thermo MX35 Ultra Blade	CS/500



Jonathan D. Kent, Ph.D.
Director of Manufacturing
and Product Development

CDI manufactures a full range
of paraffin wax formulations

PureAffin® Histology Waxes
A family of fully refined
paraffin waxes and select
additives for optimal
infiltration and embedding

PureAffin® R53™ and R56™



Low Melt Point

PureAffin® R53™ LMP

Infiltration and Embedding Medium
 PureAffin® R53™ Low Melting Point, for infiltration and embedding, consists of a specialized blend of low-molecular-weight paraffin and polymers to reduce melting point. This lower melting point protects tissues from excessive temperature during processing. R53™ is twice filtered and formulated to provide optimal structural support of properly fixed and processed tissues resulting in thin sectioning with minimal compression. R53™ is a premium all-purpose paraffin formulation; intended for use in all automated processors and embedding centers. Melting point 50-54°C

Item	Description	Qty
EELPAR53	PureAffin® R53™	CS/18 lbs



PureAffin® R56™

Infiltration and Embedding Medium
 A blend of fully refined paraffin wax and select additives. A minimal compression histology wax (56-58 C). Resealable stand-up bag.

Item	Description	Qty
EELPAR56	PureAffin® R56™	CS/18 lbs

TIP
 Using Surgipath® Formula R™?
 Try PureAffin® R56™

PureAffin® R56™ Jug

PureAffin® R56™ jug

Infiltration and Embedding Medium
 A blend of fully refined paraffin wax and select additives. A minimal compression histology wax (56-58 C). Same formula, convenient Jug packaging.

Item	Description	Qty
PAR56j	PureAffin® R56™	4.5 lbs



PureAffin® e™, i™, x™

PureAffin® 1™ and 2™



TIP
Using Paraplast®, Paraplast® Plus, or Paraplast® X-tra?
Try PureAffin® e™, i™ or x™

TIP
Using Surgipath® Infiltration Medium™ (IF-200) or EM-400™?
Try PureAffin® 1™ or 2™

PureAffin® i™:
Formulated with DMSO for enhanced infiltration. Use for both infiltration and embedding, or as an excellent infiltration paraffin in your two-step paraffin system. Designed to infiltrate fatty tissue with ease. Melting Temp~56°C

PureAffin® e™:
Can be used as a two-step paraffin system in conjunction with PureAffin i, or use as an excellent one-step paraffin for both infiltration and embedding. Melting Temp~56°C

PureAffin® x™:
A harder, "less sticky" paraffin with a lower melting point (50-53°C). Excellent for infiltration and routine cutting.

Item	Description	Qty
EEPAR1	PureAffin®-i™	CS/18 lbs
EEPAR2	PureAffin®-e™	CS/18 lbs
EEPAR3	PureAffin®-x™	CS/18 lbs

PureAffin® 1™: A purified paraffin specially formulated to provide ideal infiltration with all types of tissue specimens. Tissue Infiltration Medium is compatible with all industry paraffins. Use with open or closed tissue processors. A Compound of Purified Paraffin and additives. Stable at elevated temperatures. Melting Point 56-58°C (133-136F); Working Temperature 60°C (140F); Store Below 30°C (86F)

PureAffin® 2™: Use for both processing and embedding or with PureAffin 1 Infiltration Medium as part of two step system. Compatible with all industry paraffins. Blended to provide thorough impregnation of tissues and facilitate excellent sectioning characteristics. Use with open or closed tissue processors. A Compound of Purified Paraffin and additives. Stable at elevated temperatures. Melting Point 56-57°C (133-135F); Working Temperature 60°C (140F); Water Bath temperature 35-44°C (95-111F);

Item	Description	Qty
PARA1	PureAffin®1™	CS/18 lbs
PARA2	PureAffin®2™	CS/18 lbs

PureAffin® blue™

PureAffin® blue™: Tinted blue to provide an optimal color contrast to clear and white (especially derm) biopsies. Excellent cutting characteristics. Melting Temp ~56C

Item	Description	Qty
EEPAR2-B	PureAffin® blue™	CS/18 lbs

TIP
Using Surgipath® Blue Ribbon™?
Try PureAffin® blue™



PureAffin® BLOXX™

PREFORMED PARAFFIN FOR EFFICIENT MELTING

- PureAffin® BLOXX™**
- ▶ Preformed paraffin blocks specifically shaped to fit easily into your Peloris Tissue Processor*
 - ▶ No measuring or topping off - 1 case fills processor chamber
 - ▶ Solid blocks that don't spill and create slippery surfaces and no transferring of molten paraffin

Item	Description	Qty
PBX1	PureAffin® Bloxx™	5 x 1.8lbs. (.85kg)

* Peloris is a trademark of Leica



Ribbon™, Tissue Section Adhesive

Ribbon™ is a liquid adhesive that is convenient and reliable. Ten milliliters are added to each liter of pre-warmed water in a tissue flotation bath. Ribbon™ has been lab tested with H&E staining, special stains and immunoperoxidase procedures. Diluted Ribbon™ can be used to coat slides for frozen sections and smear preparations.

Item	Description	Qty
PCM1005	Ribbon™ Gal. (3.8L)	EA.
P1000RD	Ribbon™ 500 mL	EA.



Soft-Cut™ (Block Softener)

Soak pre-trimmed block surface in Soft-Cut™ for 5-15 minutes depending on specimen size and cut sections. Effective on nails, bone and tissue that cuts brittle and tears easily. Working Solution.

Item	Size	Qty
FX1080	Liter (1000mL)	EA.
FX1081	Gal (3.8L)	EA.

Sample Size
500mL Shown



Nail-RX™ (Nail Softening Solution, Histology)

Use pre-processing. The solution softens brittle nail clippings and makes specimens easier to cut and process. Nail RX also helps to keep specimen from washing off the slide.

Item	Size	Qty
NL0500	500 mL	EA.

Embedding Beads

Identify the embedder of a particular block with these numbered beads 0-9. Assign number to embedder or use beads as special instructions for embedding. ie: 1=embed on edge.

Item	No.	Qty
EB1000	0	PK/500
EB1001	1	PK/500
EB1002	2	PK/500
EB1003	3	PK/500
EB1004	4	PK/500
EB1005	5	PK/500
EB1006	6	PK/500
EB1007	7	PK/500
EB1008	8	PK/500



HISTO-COOL™

Histo-Cool™ was designed to help keep ice frozen throughout the day thus minimizing the need for histology personnel having to go to the freezer and hope there are spare ice trays available. In many instances those frozen ice trays are just not there. The Histo-Cool is designed for as much convenience as it is function. Available in two sizes, Red which holds 20 blocks and Blue which holds 30 blocks.

Item	Description	Qty
HCB-001R	Red- Holds 20 Blocks	EA.
HCB-001B	Blue- Holds 30 Blocks	EA.

Ancillaries



Sectioning Brush with Magnet

Brush removes loose paraffin from microtomes and embedding compound from cryostats and aids in better sectioning. The darker bristles provide a convenient contrast to sections and debris compared to lighter colored bristles. Magnet in end of handle facilitates better handling of blade; "teasing it out" for easy blade changing.

Item	Length	Dia.	Qty
SLK1000	23cm	3.5cm	EA.
SLK1003	23cm	3.5cm	PK/3



Camel Hair Section Brush Fine Tip

#1, #2, #3 #4 #5 and #6

Item	Hair Length	Dia.	Qty
A 05202	3/4"	5/32"	PK/12
B 05132	7/8"	7/32"	PK/12
C 05133	1"	1/4"	PK/12
D 05134	1 1/16"	9/32"	PK/12
E 05135	1 1/8"	11/32"	PK/12
F 05136	3 1/16"	11/32"	PK/12



Tissue Tampers

Designed to work effectively and easily for flattening tissue within the embedding mold. The shaft stays cool, even when the base is hot.

Lightweight and easy to handle with a cool shaft for holding



Actual Size

Item	Description	Size	Qty
TT2001	Standard Square-Base Plate	.5 x .5	PK/2
TT2002	Standard Round-Base Plate	.5 Diameter	PK/2
TT2003	Standard Medium-Base Plate	3/4 x 9/16	PK/2
TT2004	Large Square-Base Plate	3/4 x 1 1/16	PK/2

Forcep Tampers

Tissue Embedding Tampers aid in the orientation of tissue samples during embedding. The handle height is ideal for use with (or without) the use of forceps.

Item	Description	Qty
TT2010	Forcep Tampers 10mm x 10mm	PK/2
TT2015	Forcep Tampers 15mm x 15mm	PK/2



Slide Holders



Slide Holders

- ▶ Hold slides conveniently for drying and evaluation
- ▶ Made from chemical-resistant polyethylene
- ▶ Solid, strong construction with rubber feet for counter top stability

Item	Description	Size	Qty
SH1500	15 Slide holder	4" wide x 3/4" high x 6" deep	EA.
SH4000	40 Slide holder	4" wide x 1" high x 11 3/4" deep	EA.
SH7800	78 Slide holder	7" wide x 3/4" high x 11 3/4" deep	EA.

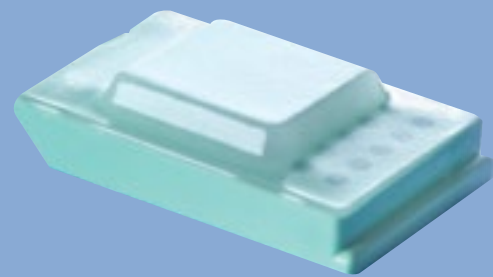

Permanent Metal Molds
feature **fast-cool precise**
molding and non-stick
easy block release

Archimedes R&D Design
Enhanced design for better
results



Archimedes Stainless Steel
Stamped from stainless steel for
superior thermal conductivity and
consistent molding



Archimedes Coating
Polished and Pearlex coated for
non-stick, easy block removal



Archimedes Final
Fast cool, non-stick. 50% faster
than traditional metal molds.

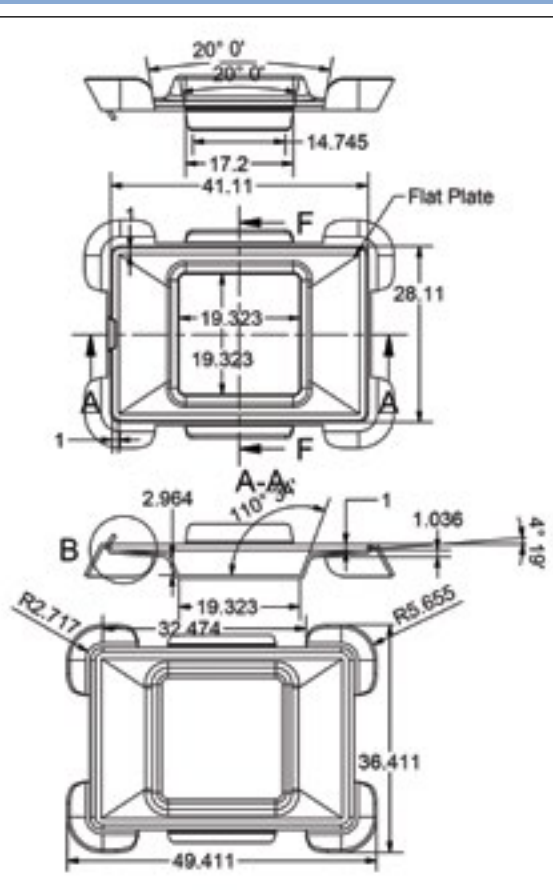

Pearlex Coated
PATENT PENDING

ARCHIMEDES™ Series Metal Base Molds

(Non Stick, Fast Cooling)

Item	Description	Size	Qty
ABM0909	Archimedes™ Base Molds	9 X 9 X 5 mm	BX/12
ABM1515	Archimedes™ Base Molds	15 X 15 X 5 mm	BX/12
ABM2424	Archimedes™ Base Molds	24 X 24 X 5 mm	BX/12
ABM3024	Archimedes™ Base Molds	30 X 24 X 5 mm	BX/12
ABM3724	Archimedes™ Base Molds	37 X 24 X 5 mm	BX/12



Metal Base Molds

Archimedes™ Atomic™ Stainless Steel Base Molds

Coated non-stick

Item	Size	Qty
MBM0707-ATM	7 x 7 x 5 mm	PK/12
MBM1515-ATM	15 x 15 x 5 mm	PK/12
MBM2424-ATM	24 x 24 x 5 mm	PK/12
MBM3024-ATM	30 x 24 x 5 mm	PK/12
MBM3724-ATM	37 x 24 x 5 mm	PK/12



Refer to pages 115-116 for additional molds

Stainless Steel Base Molds, Reusable, Heavy Duty Standard Size

Metal Base Molds are made from stainless steel and utilize internal rounded corners for easy block removal. They can be used on all standard size cassettes.

Available in packs of 12.

Item	Size	Qty
MBM0707	7 x 7 x 5 mm	PK/12
MBM1515	15 x 15 x 5 mm	PK/12
MBM2424	24 x 24 x 5 mm	PK/12
MBM3024	30 x 24 x 5 mm	PK/12
MBM3724	37 x 24 x 5 mm	PK/12

Clear Plastic Base Molds

Disposable Plastic Base Molds

CDI's redesigned clear disposable base molds are specially molded for easy separation (no sticking) from one another and makes grabbing one mold at a time effortless. Sturdy molds provide optimal support and feature flat base, squared off interior and higher walls where cassette is seated. No cassette rocking. Easy Ribboning.



- ▶ Newly Designed
- ▶ Silky Smooth. No Sticking
- ▶ Smooth Texture. Separates Easily

Item	Size	Qty
DBM0707	7mm x 7 mm x 5mm	BX/400
DBM0707-CS	7mm x 7 mm x 5mm	CS/1600
DBM1515	15mm x 15mm x 5mm	BX/400
DBM1515-CS	15mm x 15mm x 5mm	CS/1600
DBM2424	24mm x 24mm x 5mm	BX/400
DBM2424-CS	24mm x 24mm x 5mm	CS/1600
DBM3024	30mm x 24mm x 5mm	BX/400
DBM3024-CS	30mm x 24mm x 5mm	CS/1600
DBM3724	37mm x 24mm x 5mm	BX/400
DBM3724-CS	37mm x 24mm x 5mm	CS/1600

Pre-Freeze™



Pre-Freeze™ (Fresh Tissue Transport Medium For Frozen Sectioning)

A solution formulated for preservation of fresh tissue that is to be submitted for Frozen Sectioning. Perfect for transporting tissue to lab for preserving cellular structure.

Item	Volume	Qty
FX1082	500 mL	EA.
FX1083	Liter (1000 mL)	EA.
FX1084	Gal. (3.8L)	EA.



UltraFreeze™ (OCT Compound)



UltraFreeze™ Frozen Section Medium

UltraFreeze™ Frozen Section Medium is formulated to be an optimal cutting compound for frozen specimens. UltraFreeze™ does not separate from tissue as it freezes like other frozen compounds. Available clear, and in four additional colors to optimize cutting efficiency in even the busiest labs. Snip-Top with cap for variable dispensing.

Item	Description	Vol.	Qty
UF1000	Clear	4 oz	EA.
UF1002	Blue	4 oz	EA.
UF1003	Green	4 oz	EA.
UF1004	Pink	4 oz	EA.
UF1005	Yellow	4 oz	EA.

Cryostat Tissue Chucks



SC0030 Avantik-Cryostat-30mm



99-3325 Leica Circular-25mm



99-3355 Leica Circular-55mm



99-3440F Leica-Flat-40mm



SC0040 Avantik-Cryostat-40mm



99-3330 Leica Circular-30mm



99-3630 Shandon-30mm



99-3530F Thermo-Cryostar-30mm



99-3322 Leica Circular-22mm



99-3340 Leica Circular-40mm



99-3430F Leica-Flat-30mm



99-3540F Thermo-Cryostar-40mm

CHUCKS

Circular Tissue Chucks

Cryostat embedding chucks are made of anodized aluminum with a circular pattern for secure tissue mounting. Color coded for multiple specimens.

Specify desired O-Ring color by adding (-1,-2,-3,-4 or -5 after item #).

White, Blue, Teal, Red, Yellow (-1, -2, -3, -4, -5)

Item	Color	Size	Description	Qty
SC0030	(-1,-2,-3,-4,-5)	30mm	Avantik Cryostat	EA.
SC0040	(-1,-2,-3,-4,-5)	40mm	Avantik Cryostat	EA.
99-3322	(-1,-2,-3,-4,-5)	22mm	Leica Circular	EA.
99-3325	(-1,-2,-3,-4,-5)	25mm	Leica Circular	EA.
99-3330	(-1,-2,-3,-4,-5)	30mm	Leica Circular	EA.
99-3340	(-1,-2,-3,-4,-5)	40mm	Leica Circular	EA.
99-3355	(-1,-2,-3,-4,-5)	55mm	Leica Circular	EA.
99-2506	(-1,-2,-3,-4,-5)	ALL 5 SIZES	Leica Circular	PK/5
99-3630	(-1,-2,-3,-4,-5)	30mm	Shandon	EA.
99-3430F	(-1,-2,-3,-4,-5)	30mm	Leica Flat	EA.
99-3440F	(-1,-2,-3,-4,-5)	40mm	Leica Flat	EA.
99-3530F	(-1,-2,-3,-4,-5)	30mm	Thermo Cryostar	EA.
99-3540F	(-1,-2,-3,-4,-5)	40mm	Thermo Cryostar	EA.



Wax Off™ Paraffin Repellant and Remover

Spray anywhere to clean and repel paraffin. Guard against future paraffin buildup.



Item	Size	Qty
WF1030	30 mL spray bottle	CS/12
WF1000	4 oz spray bottle	CS/4

BM2™ Base Mold Release Spray

Quick-Spray onto base molds. Enables cooled paraffin blocks to release easily.

Item	Size	Qty
BM2000	8oz spray bottle	CS/4



Ancillaries

Heat Extractor (Stainless Steel) with plastic knob



Cryostat Lubrication Oil

Ultra-low temperature, light, odor free synthetic lubricating oil. Available in a 2 oz. bottle.

Item	Description	Qty
CL001	Cryostat Oil, 2 oz.	EA.

Item	Description	Qty
HE001	Heat Extractor	EA.
HEP001	Heat Extractor with Plastic Knob	EA.

Luben 2:1 (2 in 1 Cryostat and Microtome Lubricant)

Luben 2:1 is a specially formulated spray for cleaning, lubricating, and protecting cryostat and microtome machines in high volume laboratories and extreme temperature environments to -55°F. May be used on all moving parts. (3oz. 85g).

Item	Description	Qty
MCL1000	Individual Can	EA.



60 Below™, Freeze Spray

Chills to -60F. Contains no CFC's or HCFC's. Straw attached to can to localize spray onto blocks and fresh tissue.

Item	Description	Qty
06206	60 Below™	CS/6
06212	60 Below™	CS/12





MICROSCOPE
SLIDES
COVERGLASS
AND
MOUNTING
MEDIUM

HIGH QUALITY GLASS, SPECIALLY
FORMULATED MOUNTING MEDIUMS

Adhesion Slides • Non-Adhesion Slides • Specialty Slides
Coverglass • Mounting Medium



A Slide For

Every Application

NON COATED

Ink Jet Printer

Thermal Printer

Etch Printer



EM90
Page 170



AIJ90
Page 168



AIJ45
Page 168



AF45
Page 165



AF90
Page 165



AF3000
Page 161



AF3075
Page 161

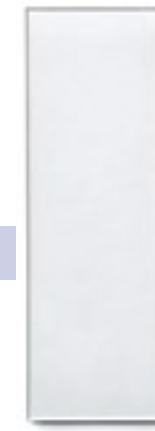

AF2575-PL
Page 164

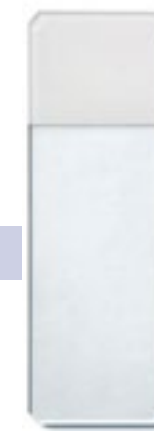

AF1000-DF
Page 164



AF2575-FR
Page 164

Plain and Frosted Slides - Not Recommended for Printing

Ink Jet printer = cartridge
Thermal (transfer) printer = ribbon
Etch "printer" = diamond stylus

COATED

Ink Jet Printer

Thermal Printer

Etch Printer



EMP90
Page 170



AMS45
Page 166



AMS90
Page 166



A45
Page 168

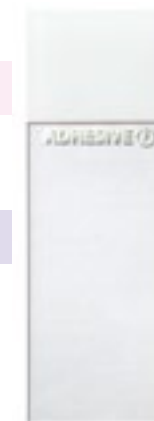

A90
Page 168



SUAPS
Page 169



4951 Plus
Page 170

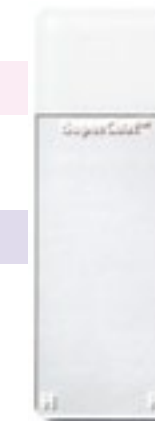

ASC45
Page 168



ASC90
Page 168



EM000W3
Page 162



EMP00W3
Page 162



TOM-11
Page 169



SUMGP
Page 169

HYDROPHOBIC

HYDROPHILIC

AutoFrost® Microscope Slides

Made from high quality glass with less alkali (for less fading) and very low self-fluorescence. The slides are cleaned using a proprietary ultrasonic process and are packaged in boxes of 100; CS/3,000. Standard #1 thickness and ~ #1.2 thickness.

Non-Charged Clipped Corner: 25mmx75mmx1.0mm

AF3000	○ White	CS/3000
AF3000-BX	○ White	BX/100
AF3001	○ Gray	CS/3000
AF3002	○ Blue	CS/3000
AF3003	○ Green	CS/3000
AF3004	○ Pink	CS/3000
AF3005	○ Yellow	CS/3000
AF3006	○ Orange	CS/3000
AF3007	○ Lavender	CS/3000
AF3008	○ Peach	CS/3000
AF3009	○ Aqua	CS/3000
AF3010	○ Tan	CS/3000

Non-Charged 90 Degree Square Corner

AF3075	○ White	CS/3000	25mmx75mmx1.0mm
AF2576-12	○ White	CS/3000	25mmx75mmx1.2mm



1.2 Thickness

1.0 Thickness

Non-Coated

AutoFrost® IHC Hydrophilic Coated Microscope Slides

Enhanced coating glass for use in IHC, nails, and tissue where special adherence is required. A proprietary coating process produces hydrophilic coating which allows user to refloat the tissue in the water bath for repositioning the tissue section and ensures compatibility with all IHC platforms (including Ventana).

Clipped Corner

EMP00W3	○ White	CS/3000
EMP00W3-BX	○ White	BX/100
EMP00B3	○ Blue	CS/3000
EMP00G3	○ Green	CS/3000
EMP00PK3	○ Pink	CS/3000
EMP00Y3	○ Yellow	CS/3000

90 Degree Square Corner

EM000W3	○ White	CS/3000
EM000W3-BX	○ White	BX/100



Coated



Autofrost® Non-Charged Microscope Slides-Frosted and Plain



AutoFrost® Double Frosted Clipped

Item	Qty
AF1000 DF	CS/1440 (10 Gross)



AutoFrost® 90 Frosted (Square)

Item	Qty
AF2575-FR	CS/1440 (10 Gross)



AutoFrost® 90 Plain (Square)

Item	Qty
AF2575-PL	CS/1440 (10 Gross)

AutoFrost® Large Slides 2 x 3 inch (50mm x 75mm x 1.0mm)

Large slides used in conjunction with Large Research Cassettes. Ordered by the piece, minimum order 500 pieces. Frosted end or plain versions. Inquire for custom sizes.

Item	Description	Qty	Item	Description	Qty
AF5075-FR	Frosted end slide, Square Corner (1.00 thickness)	PK/500	AF5075-PL	Plain Slide, Square Corner (1.00mm thickness)	PK/500
			AF5075-PL-12	Plain Slide, Square Corner (1.2 mm thickness)	PK/500

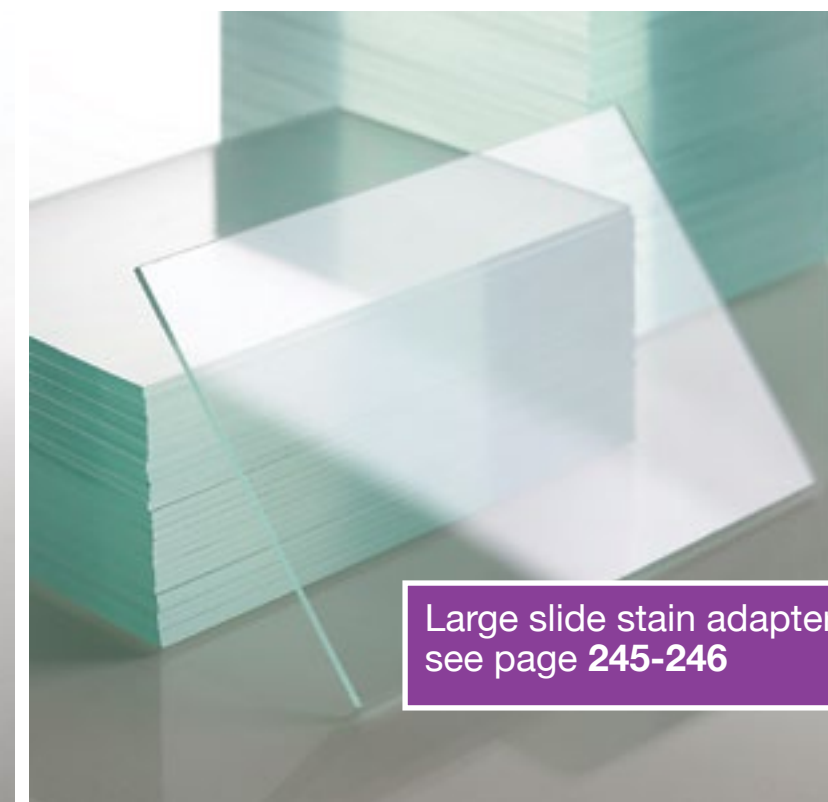
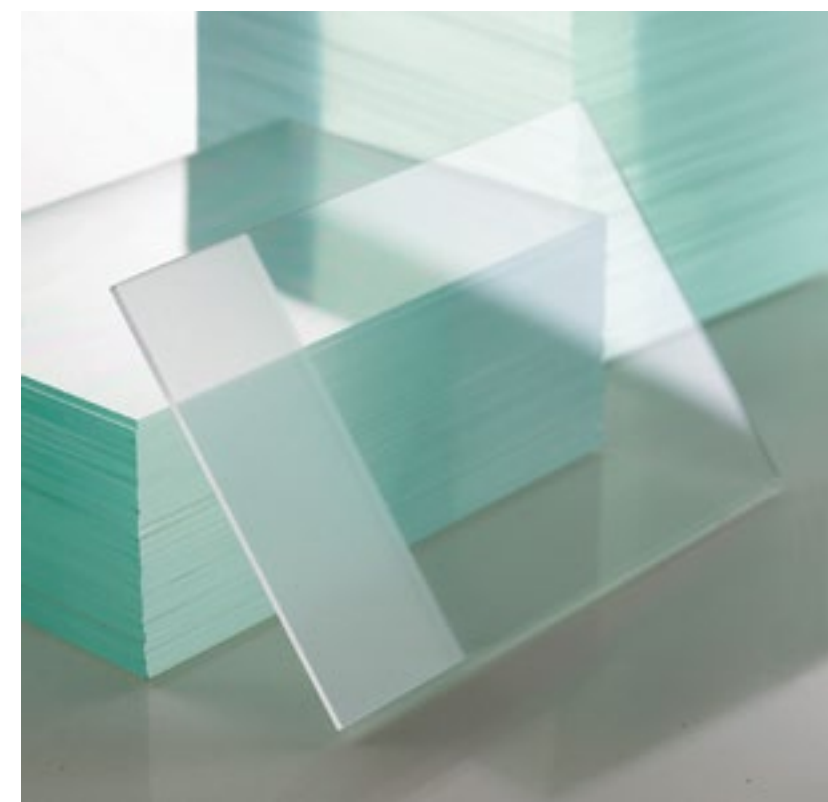

Large slide stain adapter see page 245-246

Autofrost® Non-Charged Microscope Slides (AF Series)

Routine, non charged slides available in 10 colors. Painted surface suitable for printers, labeling and writing instruments. Size: 75 x 25mm, 1mm thick, clipped corner and 90 degree (square) corner.

Non-Charged Clipped Corner			Non-Charged 90 Square Corner		
AF45-0	○ White	CS/1440	AF90-0	○ White	CS/1440
AF45-2	● Blue	CS/1440	AF90-2	● Blue	CS/1440
AF45-3	● Green	CS/1440	AF90-3	● Green	CS/1440
AF45-4	● Pink	CS/1440	AF90-4	● Pink	CS/1440
AF45-5	● Yellow	CS/1440	AF90-5	● Yellow	CS/1440
AF45-6	● Orange	CS/1440	AF90-6	● Orange	CS/1440
AF45-7	● Lavender	CS/1440	AF90-7	● Lavender	CS/1440
AF45-8	● Peach	CS/1440	AF90-8	● Peach	CS/1440
AF45-9	● Aqua	CS/1440	AF90-9	● Aqua	CS/1440
AF45-10	● Tan	CS/1440	AF90-10	● Tan	CS/1440

Autofrost® Non-Charged Microscope Sterile Slides

90 degree (square) corner. 1" x 3". White, Frosted ends.

Item	Description	Qty
AF90-ST	Non-Charged Sterile	BX/50



Non-Charged



Routine Autofrost® Adhesion Microscope Slides (AMS Series)

AutoFrost AMS (Adhesion microscope slides) for routine H&E and special staining procedures. Size: 75 x 25mm, 1mm thick, clipped corner and 90 degree (square) corner. Hydrophobic

Charged Clipped Corner			Charged 90 Degree Square Corner		
AMS45-0	○ White	CS/1440	AMS90-0	○ White	CS/1440
AMS45-2	● Blue	CS/1440	AMS90-2	● Blue	CS/1440
AMS45-3	● Green	CS/1440	AMS90-3	● Green	CS/1440
AMS45-4	● Pink	CS/1440	AMS90-4	● Pink	CS/1440
AMS45-5	● Yellow	CS/1440	AMS90-5	● Yellow	CS/1440
AMS45-6	● Orange	CS/1440	AMS90-6	● Orange	CS/1440
AMS45-7	● Lavender	CS/1440	AMS90-7	● Lavender	CS/1440
AMS45-8	● Peach	CS/1440	AMS90-8	● Peach	CS/1440
AMS45-9	● Aqua	CS/1440	AMS90-9	● Aqua	CS/1440
AMS45-10	● Tan	CS/1440	AMS90-10	● Tan	CS/1440

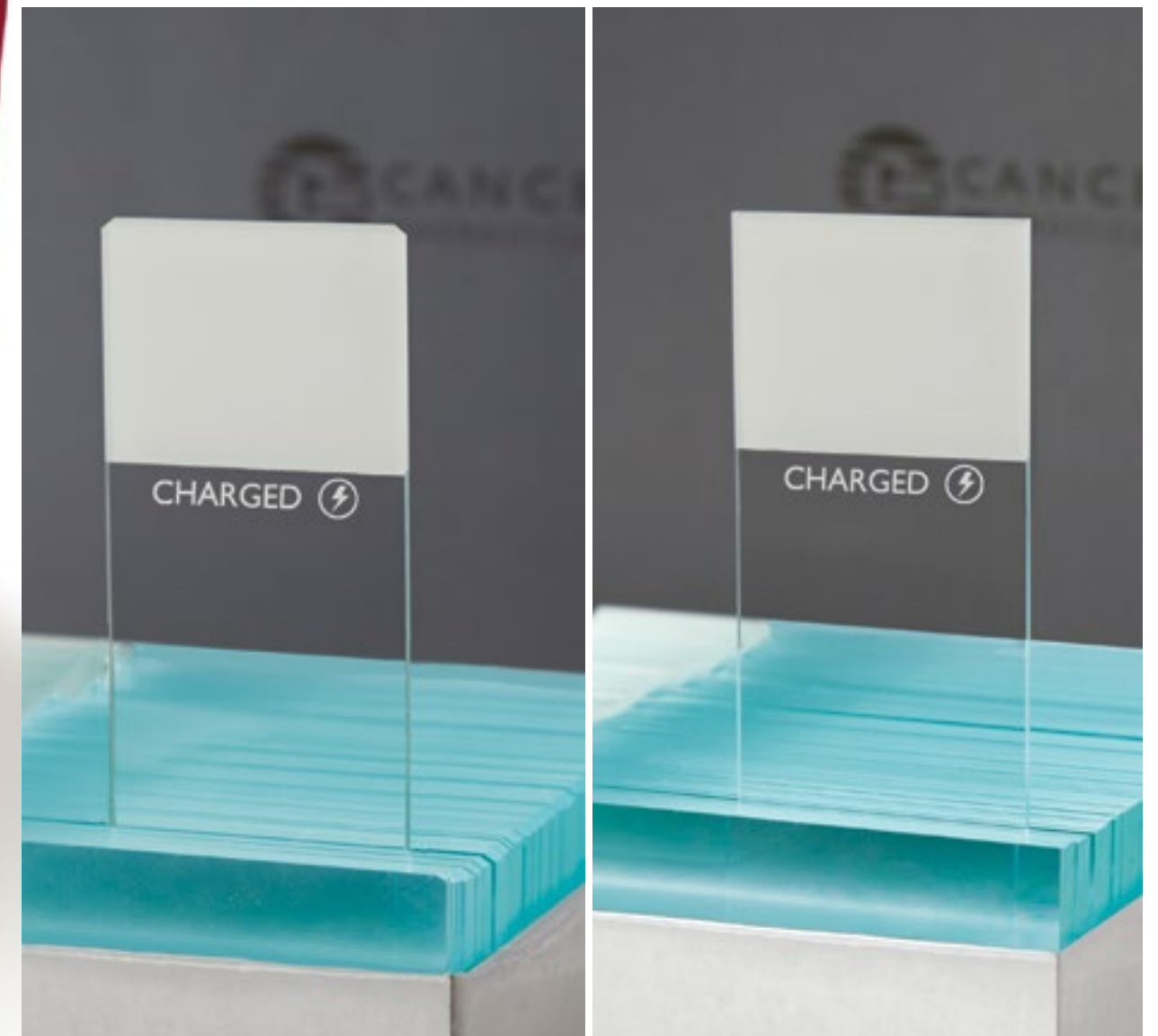

Routine Adhesive



Inkjet Slides

Autofrost® Non-Charged German Microscope Slides

Non-Charged Clipped Corner

AIJ45-0	○ White	CS/1440
AIJ45-2	● Blue	CS/1440
AIJ45-3	● Green	CS/1440
AIJ45-4	● Pink	CS/1440
AIJ45-5	● Yellow	CS/1440

Non-Charged 90° Square Corner

AIJ90-0	○ White	CS/1440
AIJ90-2	● Blue	CS/1440
AIJ90-3	● Green	CS/1440
AIJ90-4	● Pink	CS/1440
AIJ90-5	● Yellow	CS/1440

Autofrost® Adhesion German Microscope Slides

Charged Clipped Corner

A45-0	○ White	CS/1440
A45-2	● Blue	CS/1440
A45-3	● Green	CS/1440
A45-4	● Pink	CS/1440
A45-5	● Yellow	CS/1440

Charged 90° Square Corner

A90-0	○ White	CS/1440
A90-2	● Blue	CS/1440
A90-3	● Green	CS/1440
A90-4	● Pink	CS/1440
A90-5	● Yellow	CS/1440

Autofrost® Supercoat Hydrophilic German Microscope Slides

Clipped Corner

ASC45-0	○ White	CS/1440
ASC45-2	● Blue	CS/1440
ASC45-3	● Green	CS/1440
ASC45-4	● Pink	CS/1440
ASC45-5	● Yellow	CS/1440

90° Square Corner

ASC90-0	○ White	CS/1440
ASC90-2	● Blue	CS/1440
ASC90-3	● Green	CS/1440
ASC90-4	● Pink	CS/1440
ASC90-5	● Yellow	CS/1440

**Paint Optimized for
Ink Jet Printers**

APS™, IHC Adhesive Glass

The APS™ slide is treated to provide a strong permanent charge to the slide surface. Excellent for routine histology, IHC and cytology preparations.

Hydrophobic Slide Surface. Optimized for use with thermal printers.

Slides are packaged 100 per box, 10 boxes per case (1000 slides).

Clipped Corner		
SUAPS11	○ White	CS/1000
SUAPS12	● Yellow	CS/1000
SUAPS13	● Pink	CS/1000
SUAPS14	● Blue	CS/1000
SUAPS15	● Green	CS/1000



Tomo, IHC Adhesive Glass Slides

Hydrophilic, High Clarity, Low Fluorescence for use on all automated IHC Platforms (including Ventana) and especially useful in preventing tissue loss when performing high temperature antigen retrieval or enzyme digestion.

Size: 75 x 25mm, 1mm thick, clipped corner.

ISO 13485 Certified, Packaged 1,000 slides per case.

Available in White, Yellow, Pink, Blue and Green.

Clipped Corner		
TOM-11	○ White	CS/1000
TOM-12	● Yellow	CS/1000
TOM-13	● Pink	CS/1000
TOM-14	● Blue	CS/1000
TOM-15	● Green	CS/1000



MAS GP, IHC Adhesive Glass Slides

The MAS-GP slide surface is treated with a coating that creates a very strong adhesive and hydrophilic surface. The hydrophilic surface ensures faster draining of the water between the glass surface and tissue section, thereby minimizing any water trapped when the tissue section is retrieved from a water bath.

Reducing or eliminating the trapped water increases the adhesive bond between the tissue section and the microscope glass. The proprietary coating produces a strong positive charge on the slide and is highly durable to thermal treatment.

Recommended for all IHC applications and routine histology.

Optimized for use with thermal printers.

Clipped Corner		
SUMGP11	○ White	CS/1000
SUMGP12	● Yellow	CS/1000
SUMGP13	● Pink	CS/1000
SUMGP14	● Blue	CS/1000
SUMGP15	● Green	CS/1000



Superfrost® PLUS Charged Slides

Manufactured by Erie Scientific

Special treatment process that electrostatically adheres tissue sections and cells to the glass without the need for adhesives or protein coatings.

White marking surface

Size: 25 x 75mm

Item	Description	Qty
495 I PLUS	○ White	CS/1440
595 I PLUS	● Blue	CS/1440
695 I PLUS	● Green	CS/1440
795 I PLUS	● Pink	CS/1440
895 I PLUS	● Yellow	CS/1440
995 I PLUS	● Lilac	CS/1440



Etch-Mark™ Slides

A contrasting dark color is painted across the entire back of the slide for optimum viewing when front paint is etched/scribed. For use with automated microscope slide etching instruments.

Non-Charged			Charged		
EM1000	○ White	CS/1440	EMP1000	○ White	CS/1440
EM1002	● Blue	CS/1440	EMP1002	● Blue	CS/1440
EM1003	● Green	CS/1440	EMP1003	● Green	CS/1440
EM1004	● Pink	CS/1440	EMP1004	● Pink	CS/1440
EM1005	● Yellow	CS/1440	EMP1005	● Yellow	CS/1440



Slide Printer Ribbon

Hot foil tape specially designed for Thermo SlideMate Printer.

Item	Description	Qty
TSR1000	Roll 1" x 984"	EA.
TSR1005	Roll 1" x 984"	CS/5

Control Box Slides (without Tissue): Red Box & Etched Box

Adhesive slides (without control tissue) with well defined control section (either Red box or Etched/frosted box) for placement of control material and space for patient sample. 10 gross/Case.

Item	Description	Qty
ES329PLUS	Plus Control 3/4" frosted manual, red control box printed on front	Gross, 144
ES355PLUS	Plus/Coated 3/4" frosted manual, red control box printed on back	Gross, 144
16172PLUS	Plus Control 3/4" frosted automated, etched control box, etched on back	Gross, 144
ES329PLUS-CS	Plus Control 3/4" frosted manual, red control box printed on front	10 Gross
ES355PLUS-CS	Plus/Coated 3/4" frosted manual, red control box printed on back	10 Gross
16172PLUS-CS	Plus Control 3/4" frosted automated, etched control box, etched on back	10 Gross

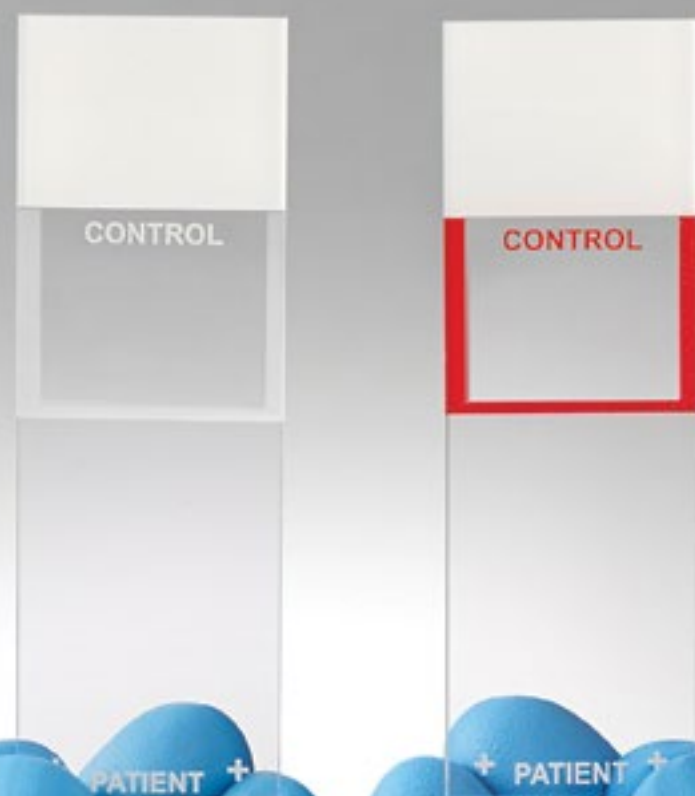

UltraSlips™ CoverGlass (Non-Stick)

Special manufacturing process and highest quality borosilicate glass produces stick-free coverglass optimized for automatic coverslippers.

- ▶ Coverglass available in sizes #1 and #1.5 thicknesses. *
- ▶ UltraSlips™ are guaranteed to be stick-free.
- ▶ Available in a Case/10 oz.

Manufactured in Germany.

* Custom Sizes available

Item	Description	Qty
GC2440-ACS	24 x 40 mm 1.0 thickness	CS/10 oz.
GC2450-ACS	24 x 50 mm, 1.0 thickness	CS/10 oz.
GCD2450-ACS	24 x 50 mm, 1.0 thickness	CS/20 oz (double case)
GC2450-1.5-ACS	24 x 50 mm, 1.5 thickness	CS/10 oz.
GC2455-ACS	24 x 55 mm, 1.0 thickness	CS/10 oz.
GC2460-ACS	24 x 60 mm, 1.0 thickness	CS/10 oz.
GC4968	49 x 68 mm, 1.0 thickness	EA. (Min. Quantity 500)
GC5063-C	50 x 63 mm, 1.0 thickness, Large	PK/100



Neo Micro Cover Glass for Automated Coverslippers

Colorless, transparent, borosilicate glass.

Processed on a fully automated production line for consistency. Manufactured in Japan with highest optical quality.

Neo Micro Cover Glass has been specially treated with a coating to prevent sticking. This coating does not interfere with optical transmission.

Item	Description	Qty
GC2440J-ACS	24 x 40 mm, 1.0 thickness	CS/5*
GC2450J-ACS	24 x 50 mm, 1.0 thickness	CS/5*
GC2455J-ACS	24 x 55 mm, 1.0 thickness	CS/5*
GC2460J-ACS	24 x 60 mm, 1.0 thickness	CS/5*

*Each case contains 5 - 200 Pcs. boxes



Premium CoverGlass

High quality cover slips packaged in all plastic box (no foam) ideal for automated and hand cover slipping.

Each case contains 10 - 1 oz. boxes.

Item	Description	Qty
CG2450	24 x 50 mm, 1.0 thickness	CS/10 oz.

Coverslip Tape



Made in Germany

Coverslip Tape

High quality automatic coverslipping film. Proprietary xylene-activated resin coated film with optical clarity comparable to glass coverslips. Developed, manufactured and quality controlled under the restrictions of DIN EN ISO 9001/14001/50001. Each roll is 70 meters in length, which can coverslip up to 1,400 slides (24mm x 50mm). Sold by the case. Each case contains 5 Rolls.

Item	Description	Qty
CTF478	Coverslip Tape	CS/5 Rolls



CoverSeal™-T (Toluene Mounting Medium)

CoverSeal™-T is a rapid drying mounting medium with low viscosity to allow free-flow of medium while reducing air bubbles.

Antioxidants are added to prevent stain fading and annual rings. CoverSeal™-T is a toluene based medium. It is soluble in Xylene, Toluene and most xylene substitutes.

Available in 500 mL glass bottles and 4 oz. Squeezer bottles with self-cleaning dispenser tops.

CoverSeal™-T

Item	Volume	Qty
FX2177	4 oz dripper bottle	EA.
FX2177-CS	4 oz dripper bottle	CS/12
FX2178	500 mL Bottle	EA.

CoverSeal™-X (Xylene Mounting Medium)

CoverSeal™-X is a rapid drying mounting medium with low viscosity to allow free-flow of medium while reducing air bubbles.

Antioxidants are added to prevent stain fading and annual rings. CoverSeal™-X is a xylene based mounting medium. It is soluble in Xylene, Toluene and most xylene substitutes.

Available in 500 mL glass bottles and 4 oz. Squeezer bottles with self-cleaning dispenser tops.

CoverSeal™-X

Item	Volume	Qty
FX2175	4 oz dripper bottle	EA.
FX2175-CS	4 oz dripper bottle	CS/12
FX2176	500 mL Bottle	EA.



MOHS or Cytology:
Coverslip directly out
of Isopropyl Alcohol or
fresh dish of 100% Ethyl



CoverSeal™-D (d-limonene Mounting Medium)

CoverSeal™-D is a unique non-toxic Toluene and Xylene-free permanent mounting medium that is compatible with all clearing agents and exhibits excellent consistency without application bubbles.

CoverSeal™-D is for laboratory use only and can be used in manual or automatic coverslipping applications. Active ingredients include: D-Limonene and Acrylic Copolymer.

CoverSeal™-D

Item	Vol.	Qty
FXD177	4 oz dripper bottle	EA.
FXD178	500 mL Bottle	EA.

CoverSeal™-PLUS (Fast Drying Universal Mounting Medium)

CoverSeal™-Plus enables slide preparations to be simultaneously cleared and coverslipped in one easy step. This unique product eliminates the need to use hazardous xylene or xylene substitutes as a clearing agent in histology and cytology laboratories.

CoverSeal™-PLUS

Item	Vol.	Qty
CS120	4 oz dripper Bottle	EA.
CS012	4 oz dripper Bottle	CS/12

CoverSeal™-AQ (Aqueous Mounting Medium)

Formulated to be used after aqueous based stains, CoverSeal™-AQ is added as a pre-mounting medium (for tissue sections, cell spreads, cytopspins or tissue imprints) following aqueous base stain prior to standard toluene or xylene based mounting media. It has the advantage of tolerating water transferred from the stain procedure.

CoverSeal™-AQ

Item	Vol.	Qty
FX2175-AQ	4 oz dripper bottle	EA.



STORAGE,
SPECIMEN
TRANSPORT,
DISPOSAL

EASY ORGANIZATION, CONVENIENT
TRANSPORT & STORAGE

Storage Files and Containers • Mailers
Biohazard Waste & Transport Bags



Filing System Slides

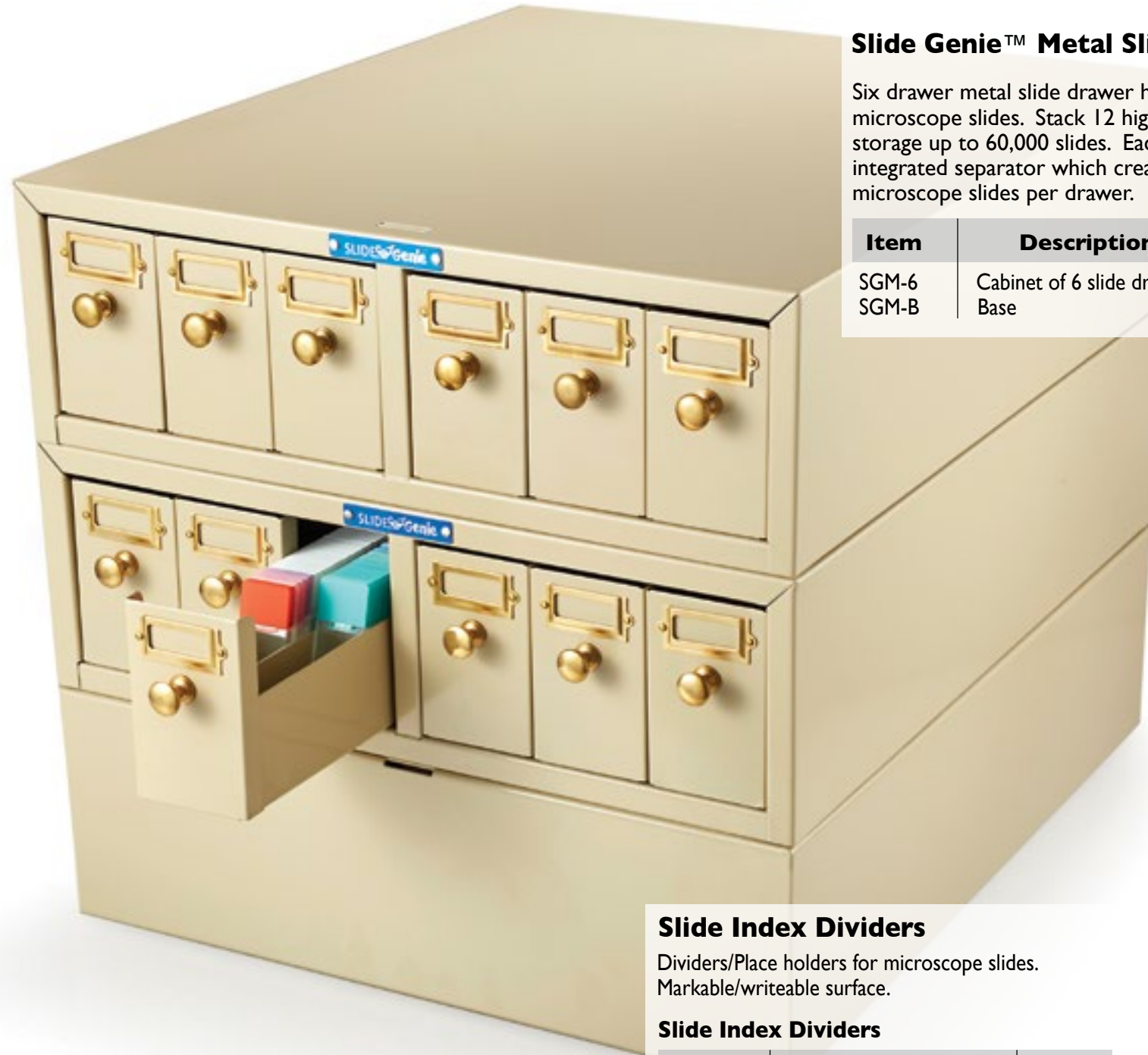

Slide Genie™ Metal Slide System

Six drawer metal slide drawer holds up to 5,000 microscope slides. Stack 12 high on base unit for storage up to 60,000 slides. Each drawer has integrated separator which creates two rows of microscope slides per drawer.

Item	Description	Qty
SGM-6	Cabinet of 6 slide drawers	EA.
SGM-B	Base	EA.

Slide Index Dividers

Dividers/Place holders for microscope slides. Markable/writeable surface.

Slide Index Dividers

Item	Description	Qty
SH-PNK	Pink (4 pads/250)	CS/1000
SH-PUR	Purple (4 pads/250)	CS/1000
SH-ORG	Orange (4 pads/250)	CS/1000
SH-YLW	Yellow (4 pads/250)	CS/1000
SH-BLU	Blue (4 pads/250)	CS/1000

Slide Number:
Name:
Date Out:
Date In:



SuperLite™ Storage Units Microscope Slides

SLIDE STORAGE
(Corrugated with plastic inserts)

SLIDE STORAGE
(All Corrugated)

SuperLite™ Storage Units Tissue Cassettes

CASSETTE STORAGE
(Corrugated with plastic inserts)

CASSETTE STORAGE
(All Corrugated)



PLASTIC INSERT



CORRUGATED PARTITIONING



Foam Retainer Blocks

PLASTIC INSERT



CORRUGATED PARTITIONING

Item	Description	Qty
CPS-6	Corrugated with Plastic Insert	EA.

Item	Description	Qty
ACS-6	All Corrugated	EA.

Item	Description	Qty
CPC-6	Corrugated with Plastic Insert	EA.

Item	Description	Qty
ACC-6	All Corrugated	EA.

5 Key Features

1

6 each, high impact polystyrene plastic trays, (7 1/2" wide x 13 1/4" deep x 2 5/8" high) or Corrugated Partitioning.

2

6 each, sturdy corrugated drawers with front labeling for easy retrieval.

3

6 each, corrugated drawer enclosures for dust-proof protection.

4

Reinforced Kraft Outer Carton for long term storage.

5

Case dimensions: 27" wide x 16 1/2" deep x 10" high.

5 Key Features

1

12 each, high impact polystyrene plastic trays, (7 1/2" wide x 13 1/4" deep x 1 3/4" high) or Corrugated Partitioning.

2

12 each, sturdy corrugated drawers with front labeling for easy retrieval.

3

6 each, corrugated drawer enclosures for dust-proof protection.

4

Reinforced Kraft Outer Carton for long term storage.

5

Case dimensions: 27" wide x 16 1/2" deep x 10" high.



Ships fully assembled



Foam Retainer Blocks

Hold Slides and Tissue Cassettes upright in partially filled trays. Reusable

- Polyurethane foam
- 1 1/2" x 1 1/2" x 1 1/2" flexible cubes
- Packaged in convenient bags of 50 foam blocks

Item	Description	Qty
FRC50	Foam Retainer Blocks	PK/50



Ships fully assembled



Filing/Storage Microscope Slides

Filing/Storage Tissue Cassettes

Original Half Drawer

Item	Description	Qty
CG1111	Fully Assembled	CS/5 (1 Unit)
CG1111	Flat/Unassembled	CS/5 (1 Unit)
CG1111-DBL-F	Flat/Unassembled	CS/10 (2 Units)

Full/High Drawer

Item	Description	Qty
CG1111-X	Fully Assembled	CS/5 (1 Unit)
CG1111-XF	Flat/Unassembled	CS/5 (1 Unit)
CG1111-DBL-XF	Flat/Unassembled	CS/10 (2 Units)

Storage Files, Slide Filing System

CDI's corrugated interlocking storage files for microscope slides are engineered to be durable and functional. An outer shell acts as a stabilizer for added support. If desired, file boxes may also be used individually without being stacked.

Designed to economically hold 2,000 slides per drawer cavity (10,000 slides per unit). Available flat, or fully assembled.

Storage Files, Cassette Filing System

CDI's corrugated interlocking files for tissue blocks are engineered to be durable and functional. An outer shell acts as a stabilizer for added support. If desired, file boxes may also be used individually without being stacked.

Designed to hold 500 tissue blocks per drawer cavity (2,500 blocks per unit). Available flat, or fully assembled.

Large Cassette Storage Files

Holds LPC 1000-1014

Item	Description	Qty
CK1000-LPC	Corrugated - one cavity, with 4 drawer	EA.



Original Half Drawer

Full/High Drawer



Full/High Drawer Pictured



Item	Description	Qty
CK1000	Fully Assembled	CS/5 (1 Unit)
CK1000-F	Flat/Unassembled	CS/5 (1 Unit)
CK1000-DBL-F	Flat/Unassembled	CS/10 (2 Units)



Each Storage File

Filing System Tissue Cassettes

BlockFile™ Cassette Filing System

Lightweight and sturdy high impact poly construction, for long-term storage of tissue blocks. Six drawer cabinet accommodates up to 1,500 paraffin blocks.

Item	Description	Qty
CFS-I	Unit, BlockFile Cassette Filing System	1 Unit

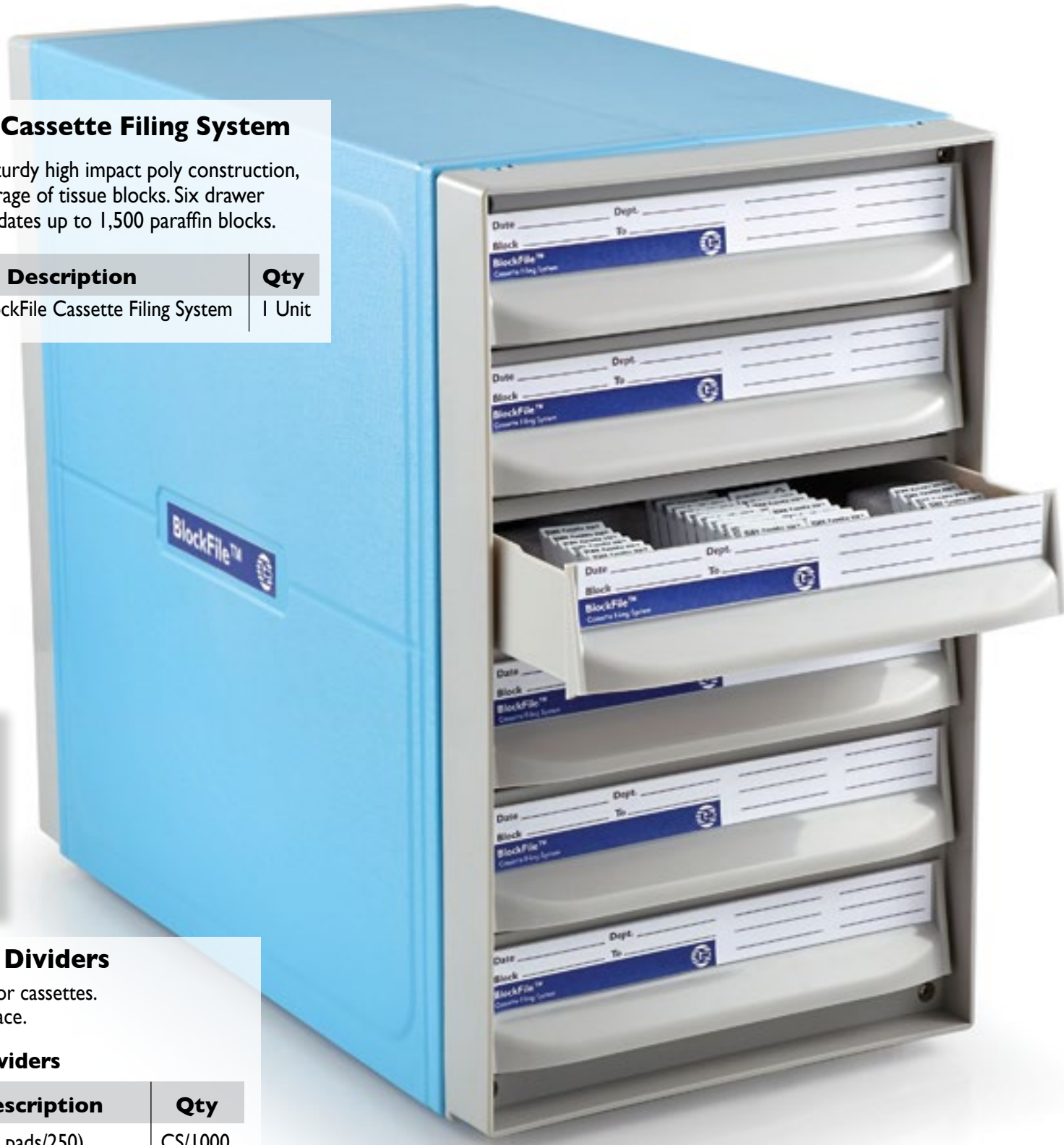

Cassette Number:
Name:
Date Out:
Date In:

Cassette Index Dividers

Dividers/Place holders for cassettes. Markable/writable surface.

Cassette Index Dividers

Item	Description	Qty
CH-PNK	Pink (4 pads/250)	CS/1000



HistoSette - Plastic Cassette Storage File

Plastic, Stackable Storage for cassette blocks. 250 cassettes per drawer. Each drawer interlocks for secure, space-saving stacking. (approx 15" x 9" x 2").

Item	Description	Qty
PK1006	HistoSette Cabinet with 6 Drawers	CS/6

(Quantity: 6 drawers pictured)



Paraffin Block Mailer

Paraffin block mailer keeps blocks secure, visible, and organized.

Item	Qty
PK1007	CS/50

Slide Folders

Chipboard Slide Folder

The 20 slide chipboard folders are made using a double wall construction, ensuring durability. Deep wells ensure slides are protected and not compromised by the closed flaps. Slides pop up when depressed on one end and the front flap(s) fold completely underneath. Available in 6 colors.

Item	Description	Qty
• AF0020-BX	Black	10 per box
• AF0020-CS	Black	CS/100
• AF0020-B	Blue	CS/100
• AF0020-G	Green	CS/100
• AF0020-R	Red	CS/100
• AF0020-W	White	CS/100
• AF0020-Y	Yellow	CS/100
• AF0020-O	Orange	CS/100
• AF0020-HP	Hot Pink	CS/100

20 Slide Folder (Plastic)

A 20-slide folder with “see through” covers. Covers are hinged and fold completely around back so folder will lay flat when accessing slides. Multiple folders can be stacked in the open or closed position. Sturdy, reusable, and easily cleaned with soap and water for years of durable use. CS/10

Item	Description	Qty
PSF1000	Slide Folder	CS/10



Slide Mailers

Slide Mailers, Chipboard

Chipboard slide mailers keep slides safe and secure during transport. One, two and four slide mailers.

Item	Description	Qty
FX8014	Single Mailer	CS/2000
FX8015	Single Mailer	PK/200
FX8016	Double Mailer	CS/1000
FX8017	4-Slide Mailer	CS/200

Slide Mailer (Plastic), Side Hinge

Translucent Plastic Slide Mailers hold one or two slides securely and economically. Snap close, easy open.

Item	Description	Qty
FX8010	Single Mailer	CS/2000
FX8011	Single Mailer	PK/200
FX8012	Double Mailer	CS/1000
FX8013	Double Mailer	PK/100



Slide Mailer

5 Slide Mailer

Sturdy plastic mailer with grooves for 5 slides. Hinged snap-top. Hole for tamper evidence. Secure close.

Item	Description	Qty
7131310	Clear	CS/100
HEA15983G	Assorted Colors - 5 of each color: Purple, Blue, Red, Yellow, Orange	PK/25

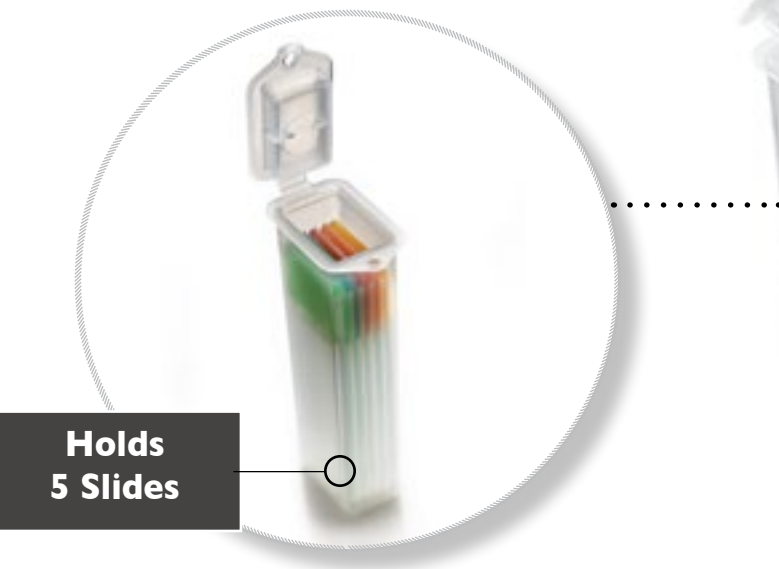

5 Slide Mailer

Translucent mailer holds five 3x1" or 25 x 75mm microscope slides. Snap top closure.

Item	Description	Qty
8131315	Clear	CS/100

2 Place Slide Mailer, Top Hinge

2-place polypropylene (top hinge) slide storage mailers hold standard (75 x 25 mm and 3 x 1") slides securely. 5 colors for easy color coding.

Item	Description	Qty
2SM00	Assorted Colors - 5 of each color: Purple, Blue, Red, Yellow, Orange	PK/25
2SM01	Clear	PK/25



4 Slide Jar

The jar is made of rigid polypropylene, has a screw cap, and is completely leak proof. This unique product is grooved so that it will accommodate up to four microscope slides and is excellent for special stains as well as mailing.

These jars are also available Pre-Filled with 95% Ethyl Alcohol for Cytology.

see cytology section - item 004095 **Page 340**

Item	Description	Qty
004250	Empty	CS/250
004095	Pre-filled	CS/50
004095-200	Pre-filled	CS/200



Slide Storage

25 Slide Box

The 25 Slide Box is made of high impact polystyrene to securely hold 25 slides. The slots are numbered, with an indexed tight-fitting lid to ensure complete protection of the slides. When the top of the slide box is removed, each slide is optimally positioned above the edge of the base enabling easy removal of the slides.

This 25 slide box is ideal for storage, kitting, mailing and for use by students and teachers.

100 Slide Box

The 100 slide box is made of high impact polystyrene and is secured with a nickel plated rust-resistant clip. Each slot is numbered and corresponds to the index on the cover to ensure proper slide identification. Available in 5 colors.

Color	25 Slide Box	25 Slide Box (CS/50)	50 Slide Box	50 Slide Box (CS/50)	100 Slide Box	100 Slide Box (CS/50)
○ White	FX8000	FX8001	FX8030	FX8030-CS	FX8020	FX8021
● Blue	FX8002	FX8003	FX8032	FX8032-CS	FX8022	FX8023
● Green	FX8004	FX8005	FX8033	FX8033-CS	FX8024	FX8025
● Red	FX8006	FX8007	FX8034	FX8034-CS	FX8026	FX8027
● Yellow	FX8008	FX8009	FX8035	FX8035-CS	FX8028	FX8029

Microscope Slide Storage Box

Redesigned with enhanced sliding open/close locking mechanism. Foam cushion inserts, durable HDPE with hinged lid.

Item	Description	Qty
SB-25	25 slide capacity, white	EA.
SB-50	50 slide capacity, white	EA.
SB-100	100 slide capacity, white	EA.



Secure Latch Version

Cryo Slide Storage Box

- The cryo slide box offers a unique solution for storing slides down to -80 C.
- Durable polycarbonate and stainless steel clasp
- Safe storage and transport of 25 x 75 mm (3 x 1 inch) slides.
- Uniform grooved slide slots separate slides preventing slide contact.

Item	Description	Qty
HS15988H	100 slide capacity, nickle hinge	EA.
HS123016	25 slide capacity, friction fit lid	EA.



100 Slides

50 Slides

Biohazard Bags

Infectious Waste, Biohazard bags

Red, dense-poly infectious waste (Biohazard) bag makes disposing of hazardous waste safer and easier. Available in various sizes and density.

Infectious Waste Bag w/Biohazard Symbol

Item	Size	Color	Density	Qty
BHZ2424	24" x 24", 8-10 Gal	Red/Black	11 microns	CS/1000 roll
BHZ2433	24" x 33", 12-16 Gal	Red	11 microns	BX/50, 20 BX Per CS
BHZ3340	33" x 40", 33 Gal	Red	14 microns	CS/500
BHZ4048	40" x 48", 40 -45 Gal	Red	16 microns	CS/250



Infectious Waste Bag Thicker Version

Item	Size	Color	Density	Qty
BHZ2323-1.1	23" x 23"	Red	1.1 mil	CS/500
BHZ2433-1.2	25" x 34"	Red	1.2 mil	CS/250
BHZ3340-1.2	33" x 40"	Red	1.2 mil	CS/250
BHZ4046-3.0	40" x 46"	Red (Thick)	3 mil	CS/75
BHZ4048-1.2	40" x 48"	Red	1.2 mil	CS/250 roll



Bags with Corrugated Box

Biomedical Waste Container, Corrugated Box & Liner, Flat Pack Print: Biohazardous/ Infectious Waste, Biohazard Symbol

Item	Size	Color	Qty
BWC25	6"x10.75"x12", 2.5 Gal	Red/Black/Red	CS/30
BWC05	12"x12"x12", 5 Gal	Red/Black/Red	CS/25
BWC11	12"x24"x12", 11 Gal	Red/Black/Red	CS/14



- 1** Reclosable Seal
- 2** 8" Document Pouch
Optional Back Flap Secures Pouch
- 3** Easy Tear-Off Top



Biohazard Transport Specimen Bags

Zip-top close and "Tear-top" open, allows for fast, convenient access to specimen. 2 mil biohazard symbol displayed on orange background. Pocket allows for segregation of paperwork.

Item	Description	Qty
FX8200	6x9	PK/200
FX8201	6x9	CS/500
FX8202	6x9	Bulk/1000
FX8202WP	6x9 (w/formalin Absorbent Pad)	Bulk/1000
FX8204	8x10	CS/500
FX8203	12x15	CS/500
FX8209	6x10	CS/1000
FX8210	10x10	CS/1000

Customize Your Own Biohazard Transport Specimen Bags

- Custom Sizes & Prints Available
- Free Artwork Processing
- No Plate Charges
- Blanket Order Stock Program
- Available for Large Quantities
- Minimum of 25,000 bags (25 cases) for 6x9, 8x10, & 12x15.





PROTECTION
SAFETY
CLEANING
AND
GENERAL
LABORATORY



PROTECTION DESIGNED FOR THE WAY YOU WORK

- Eye Protection • Sleeves and Gowns
- Monitor Badges • Disinfectants

CLEARlite PLUS™

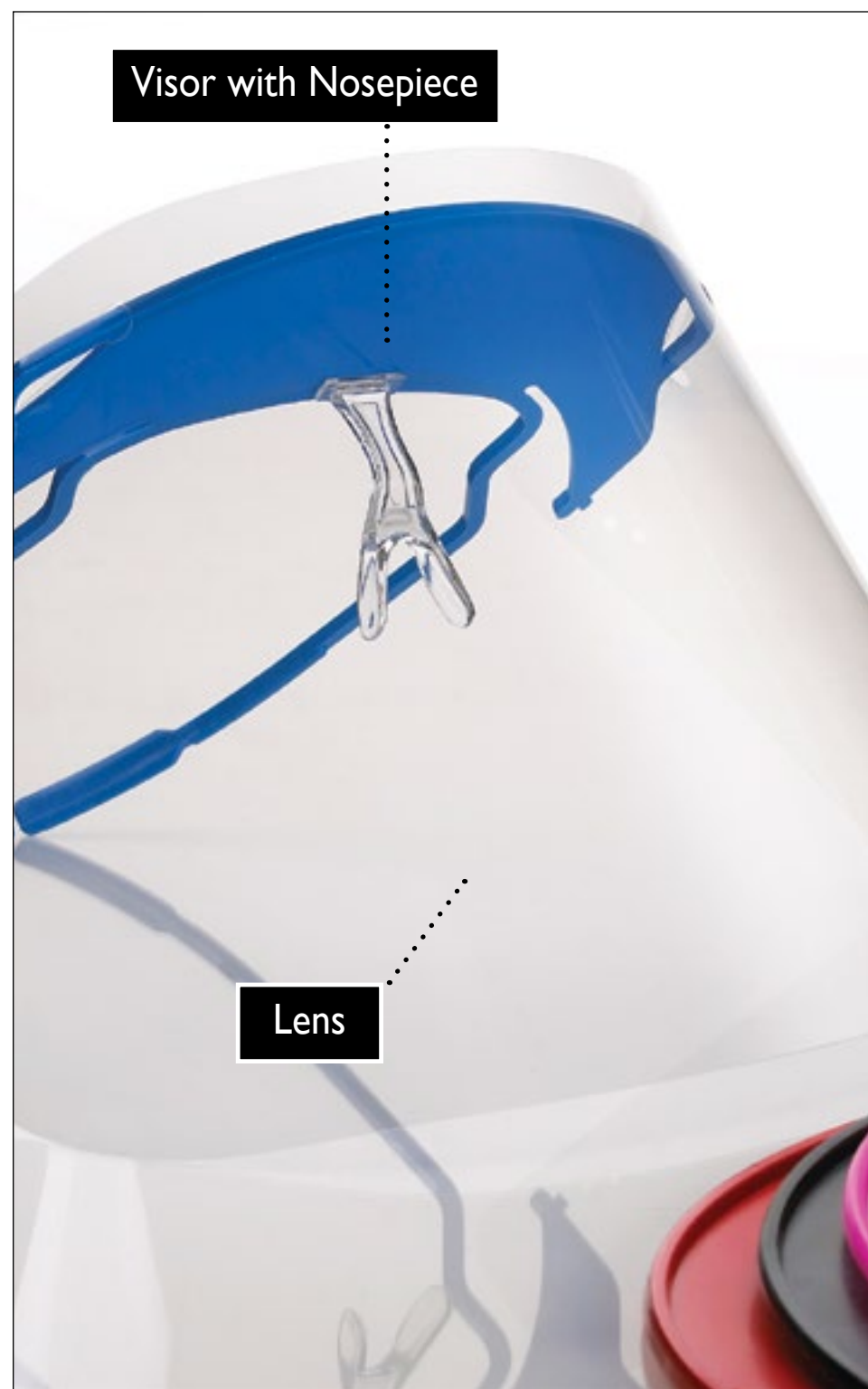

CLEARlite PLUS™

- ▶ Lightweight and comfortable for extended work sessions - weighs less than 1.5 ounces.
- ▶ Inexpensive and disposable, the clear face shield provides for safety and cost-effectiveness.
- ▶ The reusable visor is supported by a clear nosepiece and is packaged in a variety of colors.
- ▶ Remove the nosepiece and CLEARlite PLUS™ fits over most prescription eyeglasses.
- ▶ Reusable visor eliminates glare from overhead lighting and easily fits over prescription eyewear.
- ▶ Promotes compliance with OSHA regulations

Item	Description	Qty
CLPLP15	CLEARlite PLUS™ "LAB PAK", 3 Reusable visors w/Nosepieces in assorted colors, 15 Clear Shields	Each Pack
CLPF10	CLEARlite PLUS™ Visor (includes nosepiece) Reusable	PK/10
CLP100	CLEARlite PLUS™ (Clear Shield Only)	CS/100

i-Shields™

i-Shields™ (Eyeshields) - Disposable Clear Eyeshields

- ▶ Ultra Lightweight for stress free/mark free extended wearing
- ▶ Reusable frame and disposable lenses provide side shield protection
- ▶ Distortion-free, optical grade lenses work well with most sizes of prescription eyewear and can be worn with a surgical mask
- ▶ Frames packaged in a variety of colors.
- ▶ Lightweight recyclable components can be easily sterilized

Lenses and frames are ordered separately unless ordered in combo packs

Item	Description	Qty
ESPP25	"LABPAK" Professional Pack (25 Lenses and 10 Frames)	Each Pack
ES0025	Lenses Only	PK/25
ES0100	Lenses Only	PK/100
ESF010	Reusable Frames	PK/10
ESF100	Reusable Frames	PK/100

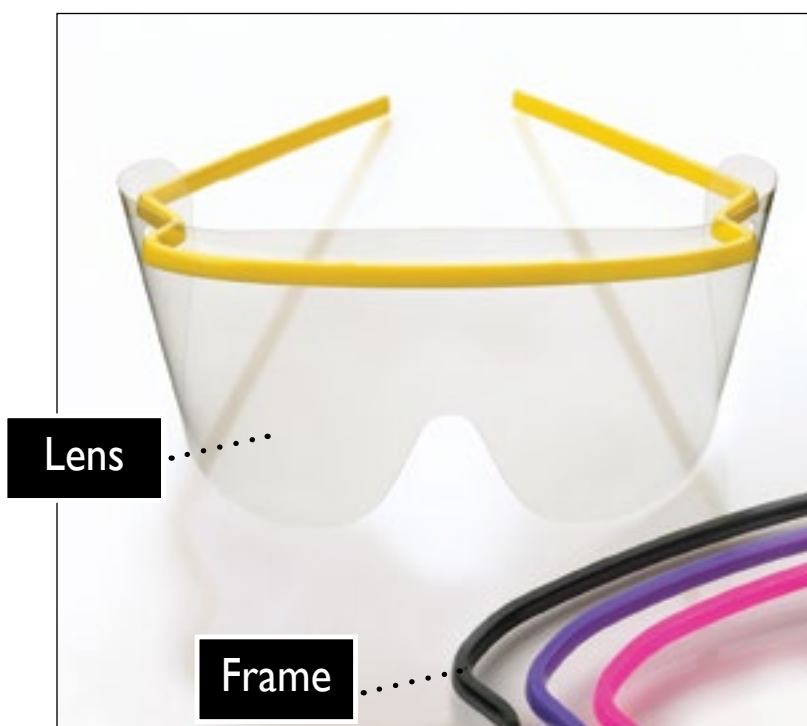

Invisi-Shields™



Invisi-shield™ Face Shield

Patented, lightweight, innovative. Simply clip the Invisi-shield™ on to one side of your glasses, curve around and clip to the other side, and you have an instant face shield.

Wear whenever splashes, spray, spatter, or droplets of blood or other potentially infectious materials occur. Frames (Item SH0625) are available if user does not wear prescription glasses.

Item	Description	Qty
GG0006	6" CDI's Face Shield	CS/12
GG0008	8" CDI's Face Shield	CS/12
SH0625	Support Frames (for Invisi-Shield Face Shields)	EA.



Arching mask with face shield



Double-Seal Ear loop, "Arching" mask with face shield

Superior structure to old masks with one or two bars. This next generation mask has pinch point bar on nose, chin and middle bar for more comfort, breathability, better protection, and less shield fogging. Latex free. Hypoallergenic for sensitive skin, softest ear loops, ultra-high filtration, PFE 99.7%, at 0.1 micron, BFE 99.5%, very breathable. Visor: Optically clear, anti-fog, anti-glare treated on both sides. Meets ASTM Level 2 standard, 120 mmHg

Item	Description	Qty
5673ADE-SB	Sky blue Mask with Face Shield	BX/25
5673ADE-WH	White Mask with Face Shield	BX/25
5673ADE-PP	Purple Mask with Face Shield	BX/25
5673ADE-PGO	Multi color Mask with Face Shield	BX/25

Masks



Double-Seal Ear loop, "Arching" mask

Superior structure to old masks with one or two bars. This next generation mask has pinch point bar on nose, chin and middle bar for more comfort, breathability, better protection. Hypoallergenic for sensitive skin, softest ear loops, ultra-high filtration, PFE 99.7%, at 0.1 micron, BFE 99.5%, very breathable.

Latex free. Sold BX/50 Meets ASTM Level 2 standard, 120 mmHg

Item	Color	Item	Color
5630ADE-AQ	Aqua	5630ADE-RB	Raspberry
5630ADE-DS	Daisy Print	5630ADE-SB	Sky Blue
5630ADE-FN	Fern Print	5630MADE-SB	Sky Blue (Mint Scented)
5630ADE-FR	Green	5630ADE-TE	Teal
5630ADE-LP	Light Pink	5630ADE-WH	White
5630ADE-PGO	Multi-Color	5630MADE-WH	White (Mint Scented)
5630ADE-PU	Plum	5630ADE-YE	Yellow
5630ADE-PP	Purple	5630ADE-PY	Puppy Print



N-95 Molded Respirator Mask

- NIOSH approved N-95 mask
- 99% filtration
- Fluid resistant
- Bare rubber straps, latex-free
- Color: White

Item	Description	Qty
5902	N-95 Mask without valve	BX/20
5904V	N-95 Mask with valve (For easy breathing)	BX/20

Gloves



Nitrile Gloves, Ultra Thin, Powder-Free, Textured

Ultra thin (3 mil) nitrile gloves offer strength, comfort and greater tactile sensitivity while maintaining highest ASTM synthetic glove standards. Ambidextrous.

Item	Size	Qty
FX4014	X-Small	BX/200
FX4014-CS	X-Small	CS/2000
FX4015	Small	BX/200
FX4015-CS	Small	CS/2000
FX4016	Medium	BX/200
FX4016-CS	Medium	CS/2000
FX4017	Large	BX/200
FX4017-CS	Large	CS/2000
FX4018	X-Large	BX/200
FX4018-CS	X-Large	CS/2000



Nitrile Gloves, Powder Free, Textured (Purple-Violet)

Chemical resistant, easy donning and conforms to the hand for comfort. Exceeds ASTM synthetic glove standards. 5 mil thickness. Ambidextrous.

Item	Size	Qty
FX4008	X-Small	BX/100
FX4008-CS	X-Small	CS/1000
FX4009	Small	BX/100
FX4009-CS	Small	CS/1000
FX4010	Medium	BX/100
FX4010-CS	Medium	CS/1000
FX4011	Large	BX/100
FX4011-CS	Large	CS/1000
FX4012	X-Large	BX/100
FX4012-CS	X-Large	CS/1000
FX4013	XX-Large	BX/100
FX4013-CS	XX-Large	CS/1000

TIP
Using Kimberly Clark Purple? Try Purple-Violet



Latex Gloves, Powder Free (Natural Latex Color)

Micro textured for superior grip. Easy donning and non-chlorinated.

Item	Size	Qty
CDI2336	Small	CS/1000
CDI2336-BX	Small	BX/100
CDI2337	Medium	CS/1000
CDI2337-BX	Medium	BX/100
CDI2338	Large	CS/1000
CDI2338-BX	Large	BX/100
CDI2339	X-Large	CS/1000
CDI2339-BX	X-Large	BX/100



Nitrile Microflex Cobalt Gloves, Powder-Free, Textured

Fully textured for enhanced grip. Enhanced tactile sensitivity. Consistent, dependable protection. 3.9 mil thickness.

Item	Size	Qty
N191	Small	CS/1000
N192	Medium	CS/1000
N193	Large	CS/1000
N194	X-Large	CS/1000



Sleeves

Aprons and Gowns



Fluid resistant

Arm Sleeve, Knit Cuff

Great arm protection with knit cuff. Fluid resistant makes these sleeves ideal for grossing. Gloves may be pulled over, or tucked into knit cuff.

Item	Qty
KC1000	PK/200
KC1002	PK/20



Elastic ends ensure secure fit

Arm Sleeve, Elastic Cuff

Tyvek® sleeves offer extra protection for arms and garments and repel liquids and particulates. Excellent for grossing and cleaning procedures. Elastic ends ensure secure fit. White.

Item	Qty	Item	Qty
NKC1000	PK/100	NKC1001	PK/10



Poly Apron with Tie

Poly Apron

White, embossed poly apron. Ties wrap completely around to the front so they can easily be tied. 28" x 46".

Item	Qty
FX8100	PK/100
FX8101	CS/500



Stirrup cuffs for wrist protection

Blue Gown (Light Contact)

Made from embossed polyethylene. Stirrup cuffs for wrist protection. Open back for increased airflow. Closed loop neck. Universal size.

Item	Qty
FX8110	PK/20
FX8111-C	CS/100

203 PROTECTION, SAFETY AND CLEANING

204 PROTECTION, SAFETY AND CLEANING

Disposable Waist Length Lab Jackets

Durable unisex lab jacket made for protection and comfort with soft 3-layer SMS material that is fluid resistant, highly breathable, and fire retardant. Latex free.

- Autoclavable & Washable Up to 5 times
- Meets OSHA Requirements
- Anti-Static Treated - No Clinging
- Hip Length
- 3 Pockets (2 hip pockets; 1 breast pocket)
- Snap Front
- Knit Cuffs and Collar
- Variety of colors

Available in PACKS/10

Color	Item	Size
 White	SC1	XS, S, M, L, 2XL, 3XL, 4XL, 5XL
 Blue	SC2	XS, S, M, L, 2XL, 3XL, 4XL, 5XL
 Orange	SC3	XS, S, M, L, 2XL, 3XL, 4XL, 5XL
 Teal	SC6	XS, S, M, L, 2XL, 3XL, 4XL, 5XL
 Red	SC8	XS, S, M, L, 2XL, 3XL, 4XL, 5XL
 Hot Pink	SC9	XS, S, M, L, 2XL, 3XL, 4XL, 5XL
 Purple	SC10	XS, S, M, L, 2XL, 3XL, 4XL, 5XL
 Multicolor	SC11	XS, S, M, L, 2XL, 3XL, 4XL, 5XL
 Navy	SC12	XS, S, M, L, 2XL, 3XL, 4XL, 5XL
 Black	SC13	XS, S, M, L, 2XL, 3XL, 4XL, 5XL
 Tan	SC14	XS, S, M, L, 2XL, 3XL, 4XL, 5XL

Please specify color and size when ordering

For Example:

White SC1- (add size to #) XS, S, M, L, 2XL, 3XL, 4XL, 5XL

Disposable Knee Length Lab Coats

Durable lab coat made for protection and comfort with SMS material that is fluid resistant, highly breathable, and fire retardant. Latex free.

- Autoclavable and Washable up to 5 times.
- Meets OSHA Requirements
- Anti-Static Treated - No Clinging
- Knee Length
- 3 Pockets (2 hip pockets; 1 breast pocket)
- Snap Front
- Knit Cuffs and Collar
- Variety of colors

Available in PACKS/10

Color	Item	Size
 White	LC1	XS, S, M, L, 2XL, 3XL, 4XL, 5XL
 Blue	LC2	XS, S, M, L, 2XL, 3XL, 4XL, 5XL
 Orange	LC3	XS, S, M, L, 2XL, 3XL, 4XL, 5XL
 Teal	LC6	XS, S, M, L, 2XL, 3XL, 4XL, 5XL
 Red	LC8	XS, S, M, L, 2XL, 3XL, 4XL, 5XL
 Hot Pink	LC9	XS, S, M, L, 2XL, 3XL, 4XL, 5XL
 Purple	LC10	XS, S, M, L, 2XL, 3XL, 4XL, 5XL
 Multicolor	LC11	XS, S, M, L, 2XL, 3XL, 4XL, 5XL
 Navy	LC12	XS, S, M, L, 2XL, 3XL, 4XL, 5XL
 Black	LC13	XS, S, M, L, 2XL, 3XL, 4XL, 5XL
 Tan	LC14	XS, S, M, L, 2XL, 3XL, 4XL, 5XL

Please specify color and size when ordering

For Example:

White LC1- (add size to #) XS, S, M, L, 2XL, 3XL, 4XL, 5XL



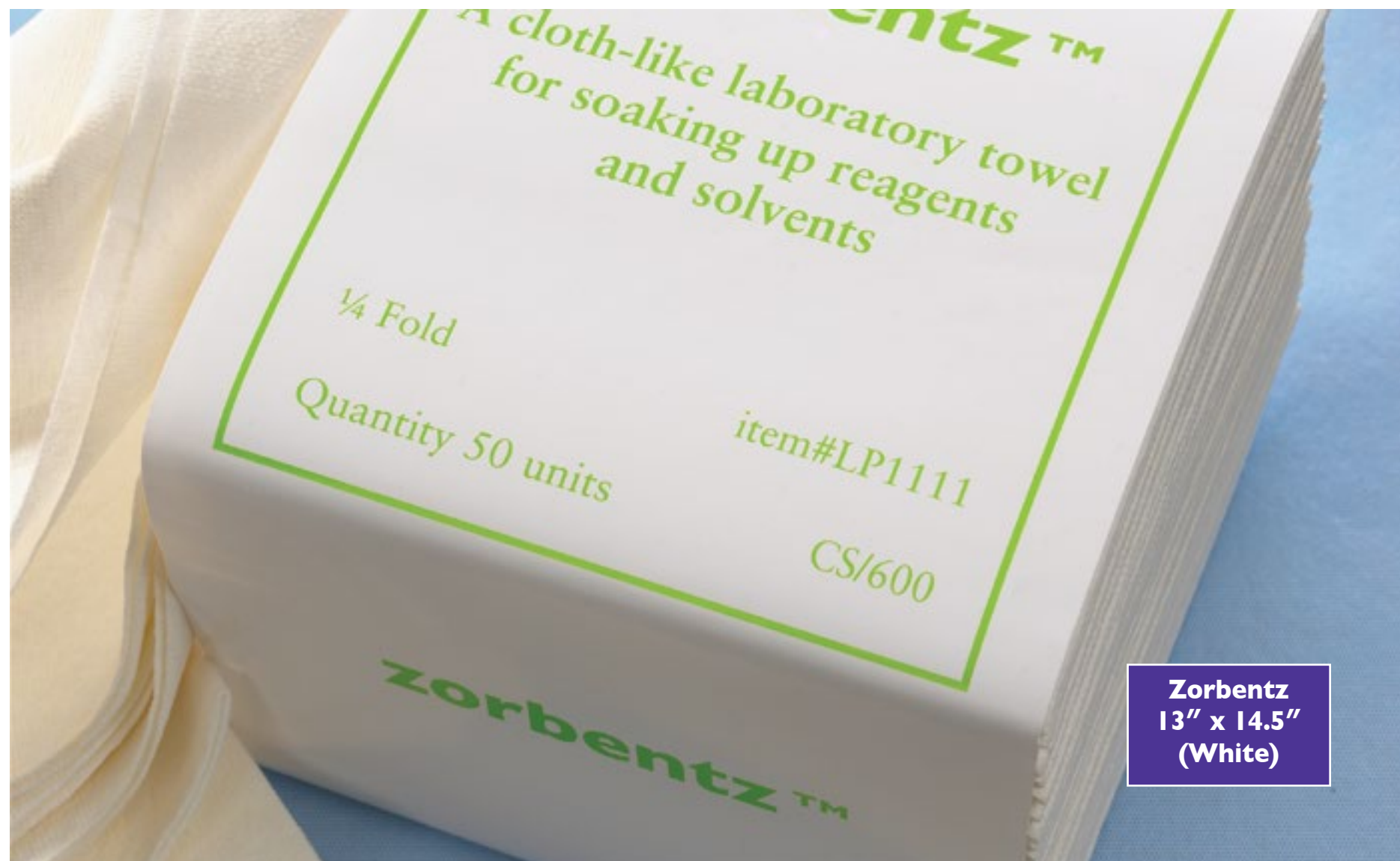

Zorbentz
13" x 14.5"
(White)

Zorbentz™ Lint Free Disposable Cloths

Zorbentz™ are a strong, highly absorbent, lint free alternative to paper towels and gauze. Zorbentz™ cloth-like softness, with no loose threads or fibers, makes them ideal for use in cover-slipping, slide preparation and general laboratory clean up. Zorbentz™ are ideally suited to soak up liquids and common solvents and are individually folded for your convenience.

Two Sizes: 13" x 14 1/2" (CS/600) and 6" x 6" (CS/1500). Available in white and blue.

Item	Color	Size	Qty
LP606	White	6" x 6" (150 x 150 mm)	CS/1500
LP1111	White	13" x 14 1/2" (325 x 368 mm), 1/4 fold	CS/600
LP1111-B	Blue	13" x 14 1/2" (325 x 368 mm), 1/4 fold	CS/600



Zorbentz
13" x 14.5"
(Blue)



Zorbentz
6" x 6"
(White)



KimWipes® Kimtech Wipers

Delicate task wipers, perfect for picking up paraffin fragments and unwanted sections from the waterbath. 4" x 8". PK/280, CS/60

Item	Size	Qty
KY1000	4" x 8"	PK/280
KY1001	4" x 8"	CS/60 (60 packs of 280)

Gauze, Pre-cut 4 x 4

For general use or for cover slipping. Highly absorbent, low lint. Non-sterile. 200 per pack.

Item	Size	Qty
GZ0404	4 Ply	PK/200
GZ0408	8 Ply	PK/200
GZ0408-2M	8 Ply	CS/2000
GZ0412	12 Ply	PK/200
GZ0412-CS	12 Ply	CS/2000



Highly absorbent

Counter Top Poly-Backed Barrier Sheets/Liner

Poly backed sheets prevent soak through when doing common laboratory tasks or shelf lining. Double layer absorbent top. Available in sheets and rolls.

Item	Size	Qty
CB1220	12" x 20"	CS/600
CB1820	18" x 20"	CS/400
CB15050	20" x 150' Roll	CS/ 4 Rolls

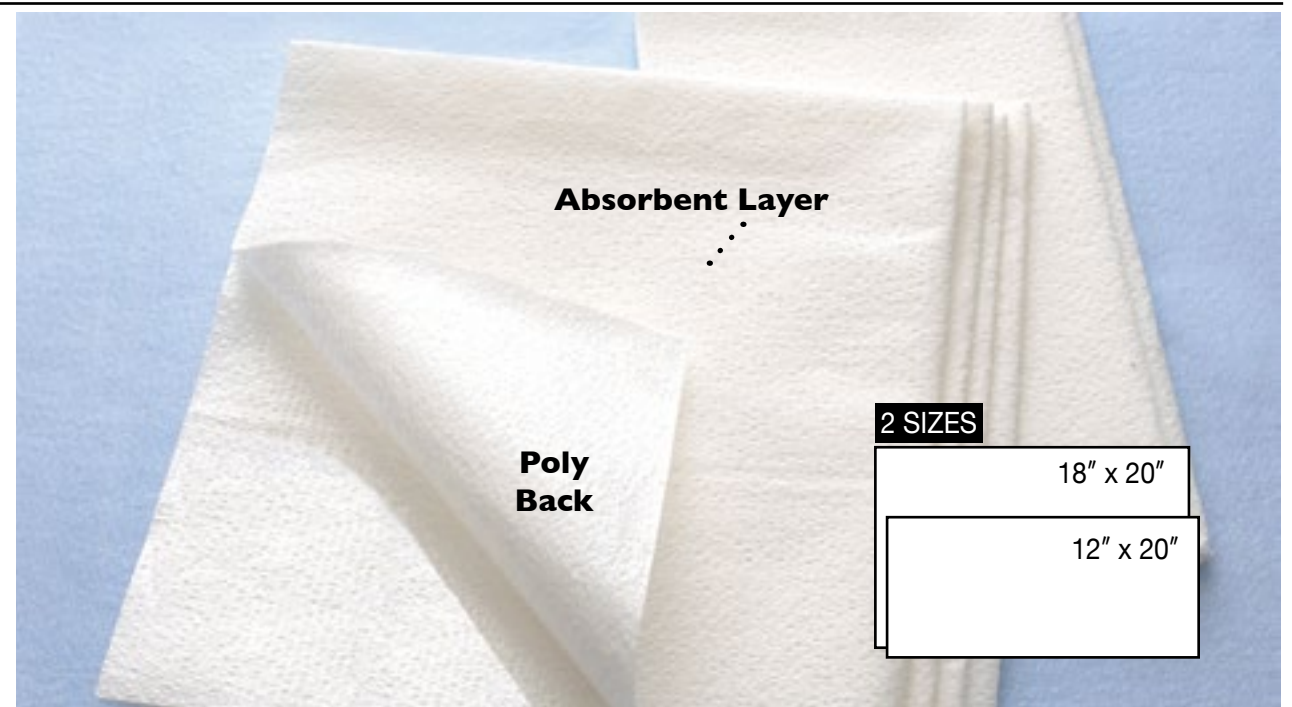



DeOderol™ Odor Neutralizing Spray

Use spray anywhere to neutralize odors. Deoderol doesn't cover up or mask odors but neutralizes them on contact. Odorless formulation.

Item	Volume	Qty
DO0717	8 oz	CS/6



Cleanerol™ Spray

Stain and Tissue Dye Remover, Paraffin cleaner and repellent for Microtomes, countertops and more. Bio-Degradable, Non-Toxic. Simply spray on and wipe off. Great for cutting boards, countertops, and more.

Item	Volume	Qty
CL2525	4 oz	CS/4



160, 6" x 6.75" premoistened towelettes in a pop-up canister



TriCide-10™ Wipes

Tricide-10™ wipes are a one-step cleaning and disinfecting solution for all pathology/necropsy lab surfaces.

Use with or without gloves for effective disinfecting against a wide range of pathogenic bacteria, viruses and fungi. This product is ideal for countertops, lab telephones, lab refrigerators, photography stations, computers, keyboards, writing instruments, splash shields, etc.

Item	Description	Qty
TC10W-4	Wipes (160 wipes per dispenser)	CS/4

TriCide-10™ Spray

Clean, disinfect, and deodorize in one easy operation. Tricide-10 is a phosphate free formula, designed for facilities where controlling the hazards of cross contamination is of prime importance. TriCide-10 is effective against: HIV-1, Herpes Simplex 1 & 2, Influenza, New Castle Disease Viruses, E-coli, Salmonella, Pseudomonas, Staphylococcus, Streptococcus, Listeria and more. Fragrance free.

Item	Description	Qty
TC10-12	32 oz. Spray	CS/12



CaviCide®

CaviCide is a convenient, ready-to-use, intermediate level surface disinfectant that is effective against TB, HBV, HCV viruses (hydrophilic and lipophilic), bacteria (including MRSA and VRE) and fungi.

Item	Volume	Qty
CV1024	24 oz.	Bottle (EA.)
CV1224	24 oz.	CS/12
CV0438	Gal.	CS/4

Smart Step® FOR THE LABORATORY



Smart Step Supreme Mats

Smart Step Supreme Anti-Fatigue Mats offer exceptional comfort and are resistant to punctures, tears, abrasions, stains, slips and wear. They are safe, non-toxic, PVC and BPA-free. Unmatched comfort and durability and anti-microbial by design. They are 1/4" thick and feature a contoured design with 20-Degree ADA-compliant beveled edges that prevent tripping and is guaranteed to remain flat (edges will never roll).

Item	Description	Qty
SS32FBLK/BRN/GRY	Smart Step Supreme 3' x 2' available in Black/Brown/Gray	EA.
SS52FBLK/BRN/GRY	Smart Step Supreme 5' x 2' available in Black/Brown/Gray	EA.
SS53FBLK/BRN/GRY	Smart Step Supreme 5' x 3' available in Black/Brown/Gray	EA.
SS54FBLK/BRN/GRY	Smart Step Supreme 5' x 4' available in Black/Brown/Gray	EA.
SS62FBLK/BRN/GRY	Smart Step Supreme 6' x 2' available in Black/Brown/Gray	EA.
SS63FBLK/BRN/GRY	Smart Step Supreme 6' x 3' available in Black/Brown/Gray	EA.

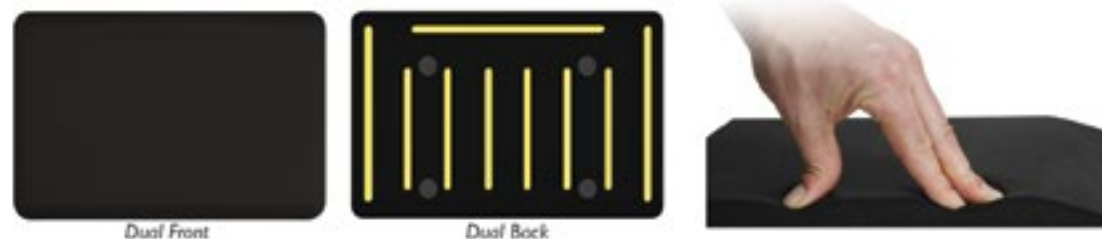

Smart Step Dual Mats

Smart Step Dual Anti-Fatigue Mats feature additional grip support for especially slippery floors in smaller areas. It features the same benefits as the original Supreme and the extra grip secures the mat in place.

Item	Description	Qty
SS32BLK/BRN/GRY	Smart Step Dual 3' x 2' available in Black/Brown/Gray	EA.

Customize your laboratory with our PuzzlePiece Collection



Custom sizing and options available through our PuzzlePiece Collection. Visit CancerDiagnostics.com to view full collection.

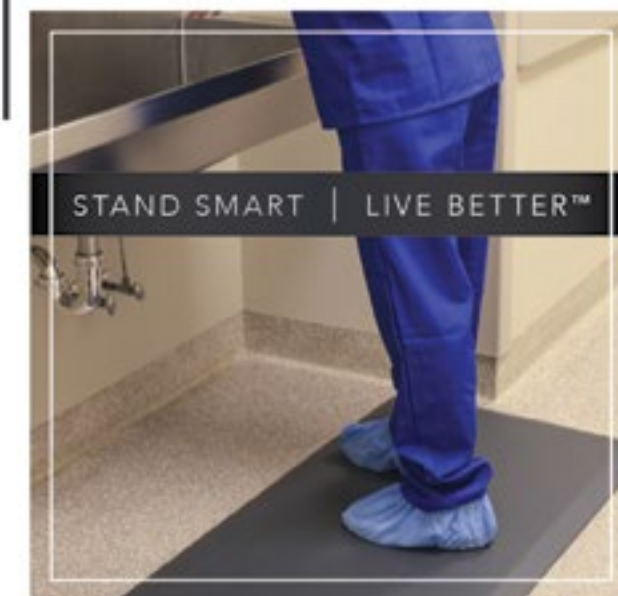

STAND SMART | LIVE BETTER™



PREMIUM PERFORMANCE MATTING





Cleanroom Sticky Mats

Sticky mats feature a tacky surface which pulls dirt and debris off shoe soles before they can contaminate a room.

- ▶ Remove and trap unwanted dirt, dust and debris from shoes
- ▶ Sticky mats act as a barricade for sterile environments
- ▶ Tacky polyethylene surface; 1/8" thick

Available in white and blue. Each case contains 4 pads of 30 sheets each.

Item	Size	Color	Qty
TMW1836	18" x 36"	White	4 pads/30 sheets ea.
TMB1836	18" x 36"	Blue	4 pads/30 sheets ea.
TMW2436	24" x 36"	White	4 pads/30 sheets ea.
TMB2436	24" x 36"	Blue	4 pads/30 sheets ea.
TMW3636	36" x 36"	White	4 pads/30 sheets ea.
TMB3636	36" x 36"	Blue	4 pads/30 sheets ea.

White Sticky Mat



Air Monitor Vapor Badges

Monitor your air quality and breathe easy! Badges include report.

1. Take Badge out of foil seal zip lock pouch and clip on collar/lapel/shirt.
2. Wear for 15 minutes or 8 hours (short term or long term exposure) and place back into pouch.
3. Send to CDI's Independent lab in pre-addressed envelopes and receive a report within 48 hours.
4. Breathe easy!

Item	Description	
XVM-6	Xylene Vapor Monitor Badge	BX/6
XVM-2	Xylene Vapor Monitor Badge	BX/2
TVM-6	Toluene Vapor Monitor Badge	BX/6
TVM-2	Toluene Vapor Monitor Badge	BX/2
IVM-6	Isopropyl Vapor Monitor Badge	BX/6
IVM-2	Isopropyl Vapor Monitor Badge	BX/2
FVM-6	Formaldehyde Vapor Monitor Badge	BX/6
FVM-2	Formaldehyde Vapor Monitor Badge	BX/2
EVM-6	Ethanol Vapor Monitor Badge	BX/6
EVM-2	Ethanol Vapor Monitor Badge	BX/2



OSHA and NIO SH validated testing methods. Accurate results accepted in any situation or governing body.

N-15™ Formalin Neutralizer Powder

N-15™ is a powdered chemical treatment for neutralizing spent formalin. Simply add one bottle (or one packet) of N-15™ per gallon of used formalin (or 4% glutaraldehyde). Bottles can be inverted onto collection container to virtually eliminate any airborne powder. Agitate gently and in under 20 minutes, the clear solution can be disposed of without clogging drains. An aldehyde kit is also available to test for residual aldehyde and includes 100 tests per box.

Item	Description	Qty
N15010	N15™ Bottles	CS/10
N15032	N15™ Bottles	CS/32 (Bulk)
N15250	Neutralizer Jug -2.5 Gal	EA.
N15020	N15™ Pouch	PK/10
N15030	N15™ Pouch	CS/30 (Bulk)
N15TKT	Formaldehyde Test Kit	EA.

2

PACKAGING OPTION



1

PACKAGING OPTION



Invert onto receptacle to allow powder to enter container, virtually eliminating all airborne powder.

Formalin/Aldehyde neutralized after 20 minutes. No precipitate, no clogging drain. Safely dispose.



Formalex® Green
 Add Formalex® "GREEN" liquid to your aldehyde waste solution, allow adequate treatment time & safely dump in sanitary sewer. Effective on both Formaldehyde & Glutaraldehyde solutions.

Item	Description	Qty
FG0001	1 Gal. Cubi-tainer with dispenser spigot	EA.
FG0025	2.5 Gal. Cubi-tainer with dispenser spigot	EA.
FG0050	5.0 Gal. Cubi-tainer with dispenser spigot	EA.
FG00IT	Aldehyde Residual Test Kit (100 test packets, color indicator, mixing bottle & pipettes)	EA.



Polyform-F™, Aldehyde Spill Control
 Polyform-F™ quickly and safely controls accidental releases and spills of formaldehyde, glutaraldehyde, and other aldehydes. Polyform-F™ destroys the aldehyde solution and eliminates harmful vapors in 2-3 minutes leaving a non-hazardous, bio-degradable polymer that can be safely and conveniently discarded.

Item	Volume	Qty
PF0032	32 oz Bottle	EA.
PF0038	Gal (3.8L)	CS/4



General Purpose Spill Response Kit

An ideal solution for small volume chemical spills. User can select from 5 specific spill control products; Acid Handler™, Base Control™, PolyForm-F™, Solvent Handler™, Chlorine Control™ for safe handling of spills.

All Kits Include; Safety Goggles, Gloves, Waste Bags and a Broom/Pan Combination

For Use On - Formaldehyde and Glutaraldehyde
 CDI-PF3202 2 x 32oz. Polyform-F Granular Shaker Bottles
 CDI-PF0102 2 x 1-Gallon Polyform-F Granular Dispenser Bottles

For Use On - Solvent Solutions
 CDI-SV3202 2 x 32oz. Solvent Handler Granular Shaker Bottles
 CDI-SV0102 2 x 1-Gallon Solvent Handler Granular Shaker Bottles

For Use On - X-Ray Fluids, Acid/Fixer and Base or Caustic/ Developer Solutions
 CDI-XR3204 2 x 32oz. Acid Handler and 2 x 32oz. Base Control Granular Shaker Bottles
 CDI-XR0102 1-Gallon Acid Handler and 1-Gallon Base Control Granular Dispenser Bottles

General Purpose Spill Response Kit (User can build their own spill kit)

For Use On - Acid, Base, Caustic, Aldehyde, Solvent, or Chlorine Solutions
 CDI-GP3204 (X-X-X-X) Choose any FOUR of the Five Spill Control Products from the product list below
 CDI-GP3202 (X-X) Choose any TWO of the Five Spill Control Products from the product list below

Spill Control Product List
A = Acid Handler **B** = Base Control **S** = Solvent Handler **P** = Polyform-F
C = Chlorine Control

Activated Carbon Filters

The carbon filters provide a high-value, low cost alternative to original manufacturer equipment filters used on many histology laboratory instruments.

The cartridges contain a high grade activated carbon which will absorb most organic and inorganic vapors including xylene, toluene methanol, neutral buffered formalin 10%, isopropyl alcohol and industrial denatured alcohol.

To ensure air quality in the laboratory is maintained to safe and acceptable standards, it is essential that the carbon filters in equipment using solvents and other potentially harmful products are replaced at the manufacturer's recommended interval. Failure to do so may result in excessive vapors building up in the laboratory environment. The manufacturer's recommended intervals are shown below.



S100

- ▶ Significant cost savings compared to instrument manufacturer equivalent.
- ▶ Lower cost.
- ▶ Same performance as manufacturer filters.
- ▶ Identical size and fitting.

Item	Manufacturer	Equipment	Replacement Interval *	Equivalent
S100	Tissue-Tek (Sakura)	DRS Stainer	3 monthly	Sakura 2008
S200	Tissue-Tek (Sakura)	SCA Coverslipper	3 monthly	Sakura 4775
S300	Tissue-Tek (Sakura)	Prisma Range, VIP 6, Express X50	3 monthly	Sakura 6160
S400	Tissue-Tek (Sakura)	Express X120	3 monthly	Sakura 7107
S500	Tissue-Tek (Sakura)	VIP 5, VIP Jr, E-150, E-300	3 monthly	Sakura 4899
LC100	Leica	AutoStainer XL ST5010	3 monthly	Leica: I4047432273
LC100	Leica	Multistainer ST5020	3 monthly	Leica: I4047432273
LC100	Leica	Linear Stainer ST4040	3 monthly	Leica: I4047432273
LC200	Leica	Coverslipper CV5000	3 monthly	Leica: I4046435914
LC300	Leica	Tissue Processor TPI050	3 monthly	Leica: I4046135332
LC400	Leica	Tissue Processor ASP300/ASP3005	3 monthly	Leica: I4047634150
LC500	Leica	Coverslipper CV5030	3 monthly	Leica: 042 230 673
LC500	Leica	Coverslipper CV5030 (Enhanced)	3 monthly	Leica: 042 230 674
T100	Thermo Scientific (Shandon)	HyperClean (Enhanced)	4 weekly	Shandon: 9990612
T200	Thermo Scientific (Shandon)	GLX Stainer	3 monthly	Shandon: 9990610
T200	Thermo Scientific (Shandon)	HyperClean Fume Hood	3 monthly	Shandon: 9990610
T200	Thermo Scientific (Shandon)	Consul/ ClearVue Coverslipper	3 monthly	Shandon: 9990610
T200	Thermo Scientific (Shandon)	Excelsior Tissue Processor	3 monthly	Shandon: 9990610
T200	Thermo Scientific (Shandon)	Varistain Stainer/ Gemini ES Stainer	3 monthly	Shandon: 9990610
T300	Thermo Scientific (Shandon)	HyperClean Excelsior & Tissue Processor	4 weekly	Shandon: 9990612

* The replacement intervals are based on the current instrument equipment manufacturer guidelines. Replacement will vary significantly depending on throughput.



S200



S300



S400



S500



LC100



LC200



LC300



LC400



LC500



T100



T200



T300



STAIN SYSTEMS



COMPLETE STAINING, CONSISTENT RESULTS

Hematoxylin and Eosin

FNA & Frozen Section Staining • DermaStains • Powdered Stains
Special Stain Components • Staining Accessories • Filters



H & E Staining

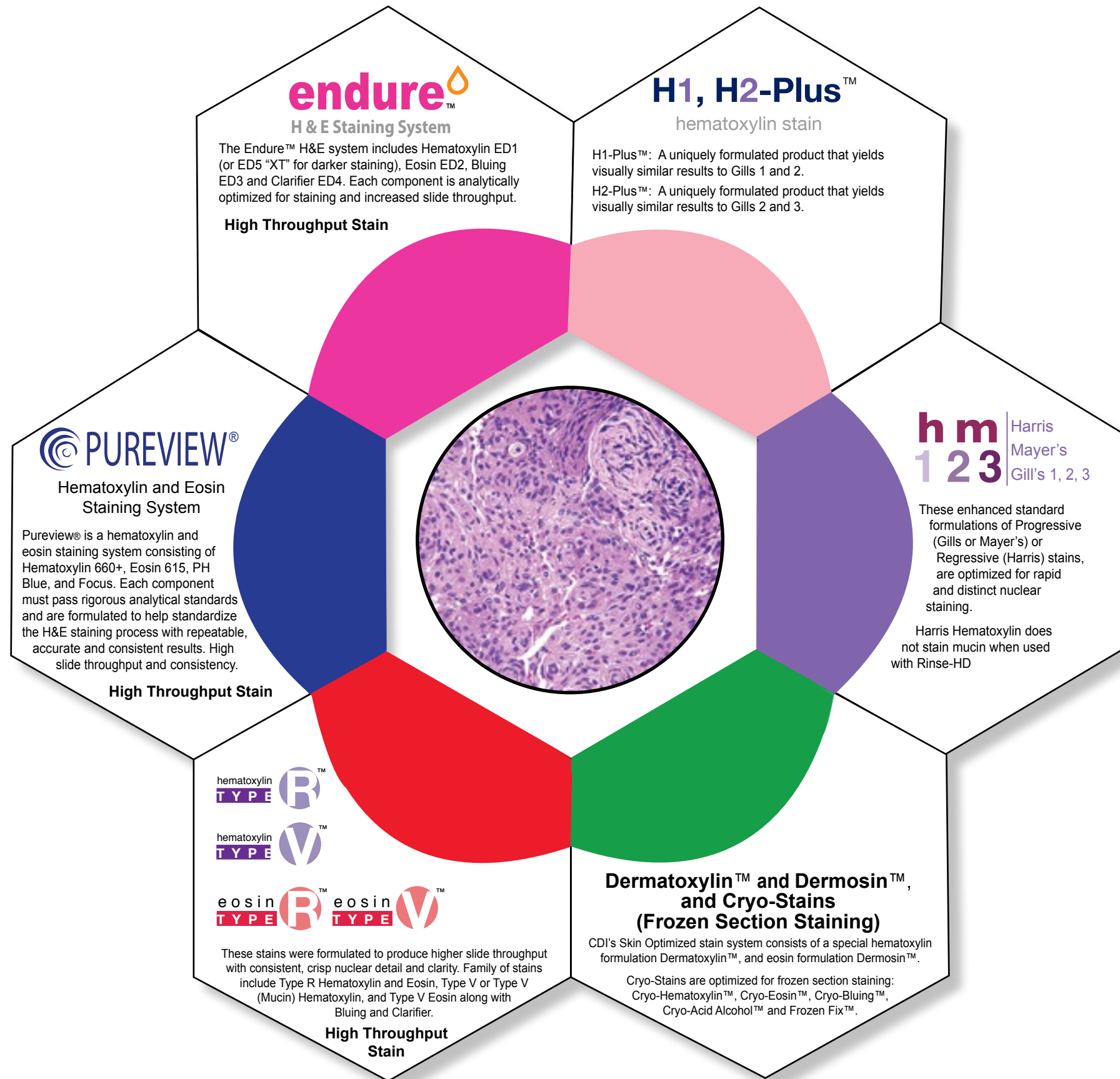

Stains

H1-Plus™ Hematoxylin Stain

Formulated to be more stable and consistent than traditional Gill's formulation, H1-Plus™ is a progressive nuclear stain formulated to replace Gill's 1 or Gill's 2 type hematoxylin. The intensity of nuclear staining is determined by the amount of time tissue sections are exposed to H1-Plus™. This stain will not form crystals, requires no daily filtering, and does not contain mercury or alcohol.

H2-Plus™ Hematoxylin Stain

A more potent version of H1-Plus™ formulated for more staining intensity to replace Gill's 3 or Harris type hematoxylin. This stain will not form crystals, requires no daily filtering, and does not contain mercury or alcohol.



TIP:
Using Richard Allan Hematoxylin 1 and 2?
Try H1-Plus™ and H2-Plus™

H1- Plus™

Item	Vol	Qty
H1P4	500mL	CS/4

H2- Plus™

Item	Vol	Qty
H2P4	500mL	CS/4

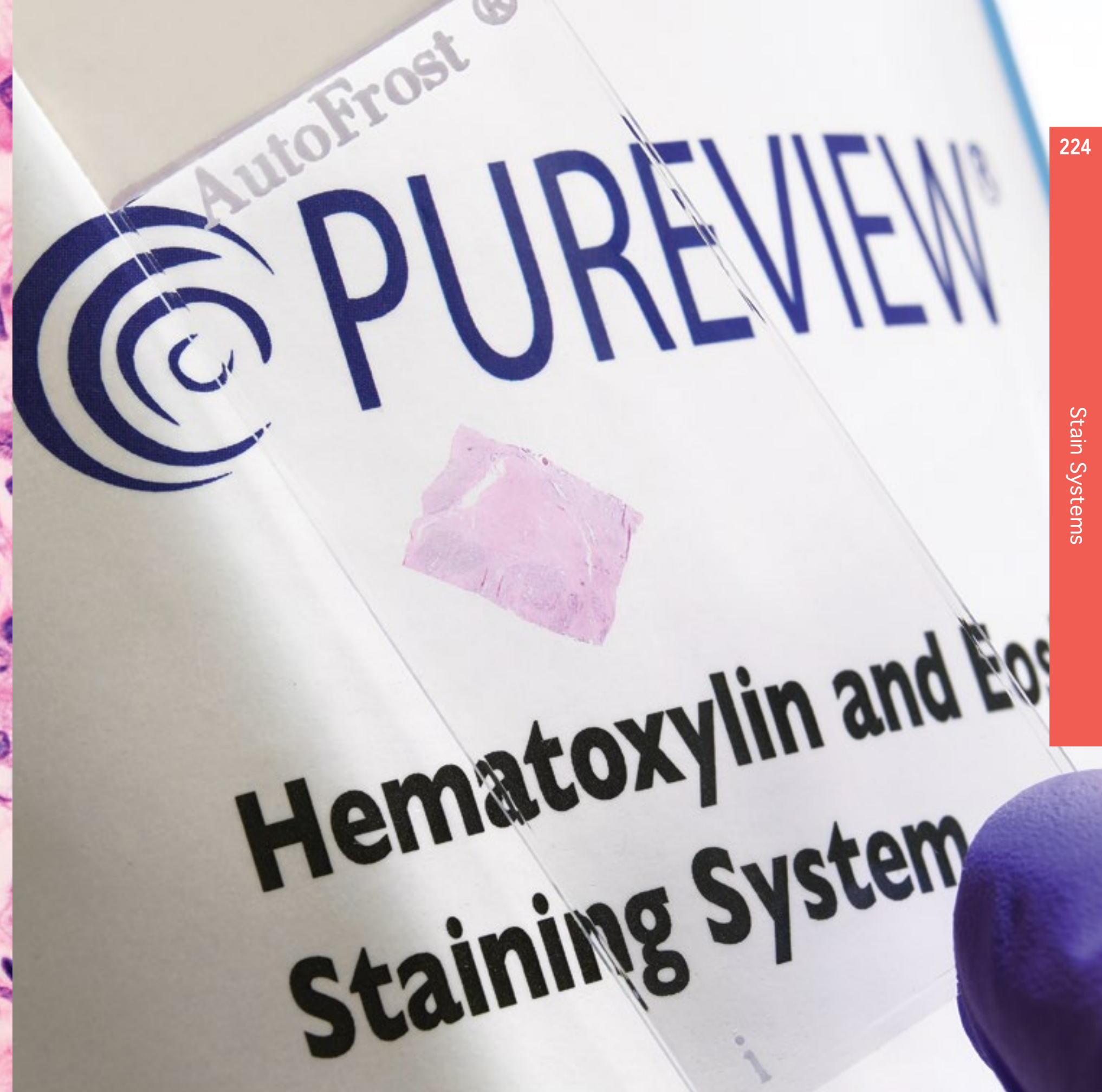
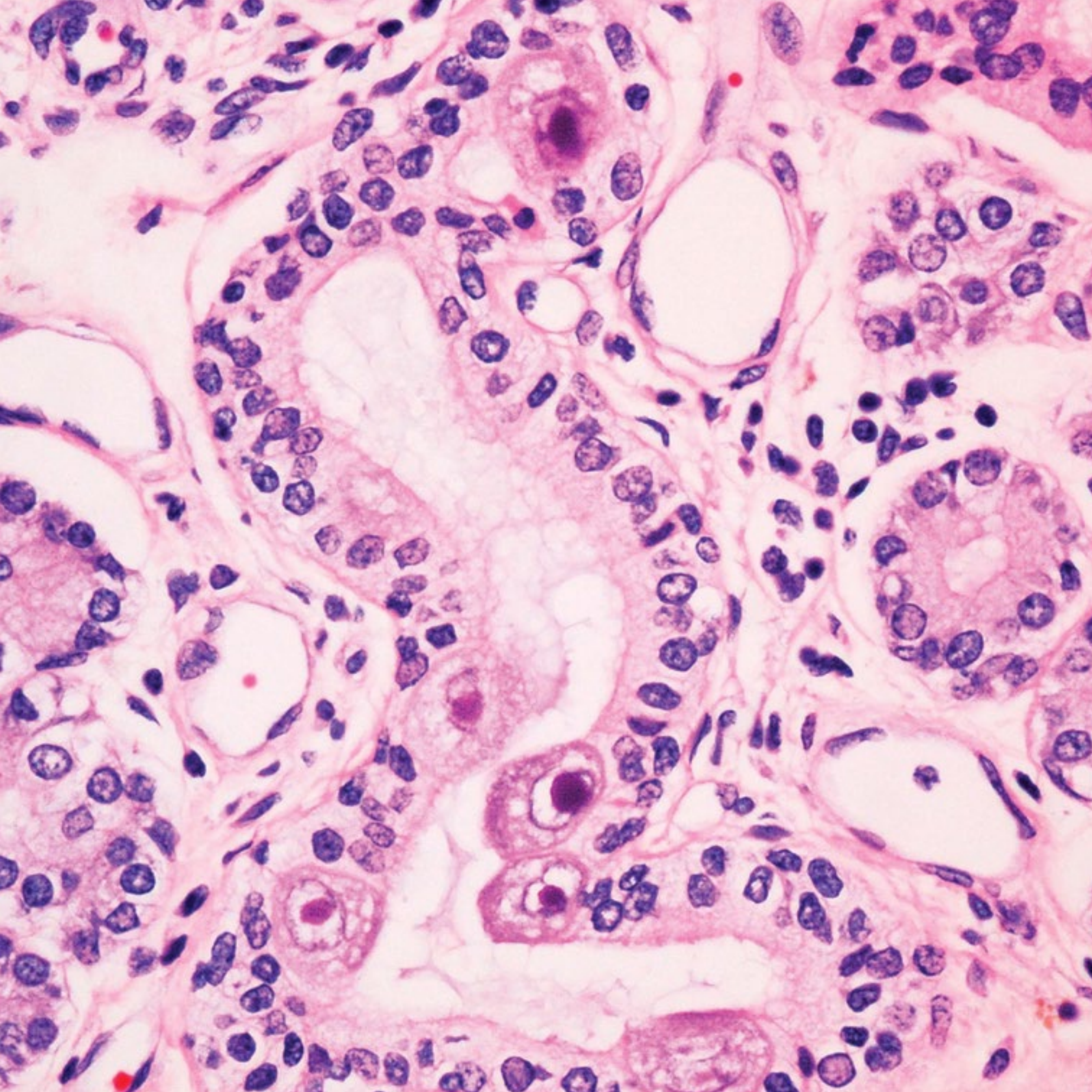

Pureview® Stains

Pureview® Hematoxylin 660+™

A certified, pre-filtered progressive hematoxylin. It is formulated to stain longer than traditional hematoxylin and produces crisp, well delineated nuclear chromatin. Use XL version for darker staining/shorter time.

Item	Description	Vol	Qty
16600	Pureview 660+	500 mL	EA.
16600-4	Pureview 660+	500 mL	CS/4
16600-XL	Pureview 660+XL	500 mL	EA.
16600-XL4	Pureview 660+XL	500 mL	CS/4

Pureview® Eosin 615™

A pre-filtered optimal differentiator. Red blood cells stain red, and connective tissue stains varying shades of pink to orange.

Item	Description	Vol	Qty
16601	Eosin 615	500 mL	EA.
16601-4	Eosin 615	500 mL	CS/4
16601-LT	Eosin LITE	500 mL	EA.
16601-LT4	Eosin LITE	500 mL	CS/4
16601-PH	Eosin w/Phloxine	500 mL	EA.
16601-PH4	Eosin w/Phloxine	500 mL	CS/4
16601-TC	Eosin Trichrome	500 mL	EA.
16601-TC4	Eosin Trichrome	500 mL	CS/4

TIP:
Using Surgipath®
SelecTech Stains?
Try Pureview® Stains

Pureview® Focus®

A clarifier that removes non-specific staining and background haze. Focus is formulated to sharpen nuclear detail producing a finishing effect that optimizes nuclear detail. Available in a gallon working solution or concentrate formula.

Item	Description	Vol	Qty
16703	Working Solution (RTU)	Gal. (3.8L)	EA.
16703-4	Working Solution (RTU)	Gal. (3.8L)	CS/4
16703-C	Concentrate (Aqueous)	500 mL	EA.
16703-C4	Concentrate (Aqueous)	500 mL	CS/4
16703-AL-C	Concentrate (Alcoholic)	500 mL	EA.
16703-AL-C4	Concentrate (Alcoholic)	500 mL	CS/4

Pureview® PH Blue™

A bluing reagent buffered to a constant pH 8. Fluctuations in pH have been associated with “floaters” and unclear nuclear detail. PH Blue is designed to be unaffected by carryover and is formulated to help standardize the staining process. Available in a gallon working solution or concentrate formula.

Item	Description	Vol	Qty
16702	Working Solution	Gal. (3.8L)	EA.
16702-4	Working Solution	Gal. (3.8L)	CS/4
16702-C	Concentrate	500 mL	EA.
16702-C4	Concentrate	500 mL	CS/4





Endure™ Clarifier

Item	Description	Vol	Qty
ED4	Aqueous Clarifier	Gal. (3.8L)	EA.
ED44	Aqueous Clarifier	Gal. (3.8L)	CS/4
ED6	Alcoholic Clarifier	Gal. (3.8L)	EA.
ED64	Alcoholic Clarifier	Gal. (3.8L)	CS/4



Endure™ Bluing

Item	Description	Vol	Qty
ED3	Endure™ Bluing	Gal. (3.8L)	EA.
ED34	Endure™ Bluing	Gal. (3.8L)	CS/4

TIP:
Using Richard-Allan Scientific™
Signature Series?
Try Endure™



endure™

H & E Staining System

The Endure™ Staining System is designed to produce precise, consistent H&E staining.

Staining times in hematoxylin and eosin will depend on the use and the personal preference of the diagnosing physician. CDI has guidelines that will help establish a custom protocol for your specific needs.

The Endure™ H&E System includes Hematoxylin ED1, (or ED5 "XT" for darker staining), Eosin ED2, Bluing ED3 and Clarifier (Aqueous) ED4 or Clarifier (Alcoholic) ED6. Each component is analytically optimized for staining consistency and longevity.

Endure™ Hematoxylin

Item	Description	Vol	Qty
ED1	Endure™ Hematoxylin	500 mL	EA.
ED14	Endure™ Hematoxylin	500 mL	CS/4

Endure™ Hematoxylin-XT

Item	Description	Vol	Qty
ED5	Endure™ Hematoxylin-XT	500 mL	EA.
ED54	Endure™ Hematoxylin-XT	500 mL	CS/4

Endure™ Eosin

Item	Description	Vol	Qty
ED2	Endure™ Eosin	500 mL	EA.
ED24	Endure™ Eosin	500 mL	CS/4

HIGHER SLIDE THROUGHPUT WITH CONSISTENT,
CRISP NUCLEAR DETAIL AND CLARITY



Eosin Type V is a classic formulation of the alcoholic eosin-Y counterstain. Eosin Type V produces brilliant counterstaining and differentiation of cell cytoplasm and other non-nuclear tissue components.

Eosin Type V is ready to use and has been balanced to the proper pH for consistency and stability.



The polychromatic formulation of Eosin Type R uses a combination of 3 dyes to produce exceptional contrast and staining of cytoplasmic cell structures.

Eosin Type R is ready to use and has been balanced to the proper pH for consistency and stability.



Eosin Type R w/Phloxine B is a classic formulation of the alcoholic eosin-Y counterstain with the addition of the Phloxine dye. It produces brilliant counterstaining with a more vivid red hue.

Eosin Type R w/Phloxine B is ready to use and has been balanced to the proper pH for consistency and stability.



Hematoxylin Type V Mucin can be used in place of Gill's Hematoxylin formulations for applications where mucin staining is desired.

The progressive nature of this stain allows users to adjust to their desired staining intensity by simply adjusting staining times. Hematoxylin Type V Mucin requires no daily filtering.



The hybrid formulation of Hematoxylin Type R produces crisp nuclear detail and does not stain mucin. Hematoxylin Type R can be used in place of Gill's or Harris Hematoxylin formulations.

This progressive stain allows users to adjust to their desired staining intensity by simply adjusting staining times. Hematoxylin Type R requires no daily filtering.



The unique formulation of Hematoxylin Type V produces crisp nuclear detail without background staining. Hematoxylin Type V can be used in place of Gill's Hematoxylin formulations.

The progressive nature of this stain allows users to adjust to their desired staining intensity by simply adjusting staining times. Hematoxylin Type V requires no daily filtering.

Hematoxylin & Eosin Type R™ & V™ Staining System

TIP:
Using Vintage/Reserve stains?
Try Type V or Type R



Hematoxylin V

Item	Vol	Qty
HTV	500mL	EA.
HTV-4	500mL	CS/4

Hematoxylin Type V Mucin

Item	Vol	Qty
HTM	500mL	EA.
HTM-4	500mL	CS/4

Eosin V

Item	Vol	Qty
ETV	500mL	EA.
ETV-4	500mL	CS/4

Hematoxylin R

Item	Vol	Qty
HTR	500mL	EA.
HTR-4	500mL	CS/4

Eosin Type R with Phloxine B

Item	Vol	Qty
EPHB	500mL	EA.
EPHB-4	500mL	CS/4

Eosin R

Item	Vol	Qty
ETR	500mL	EA.
ETR-4	500mL	CS/4

* To use as a complete system use Endure™ Bluing (ED3/ED34) and Endure™ Clarifier (ED4/ED44)

All stains are filtered prior to bottling and use a special process to ensure optimal freshness.

Mayer's Hematoxylin

Used for routine H&E and immunocytochemistry.

Item	Name	Vol	Qty
CM3951	Mayers	Gal.(3.8L)	EA.
CM3952	Mayers	Liter (1000mL)	EA.
CM3953	Mayers	500mL	EA.

Mercury Free Harris Hematoxylin

Produces a deep, dark blue-purple stain. It is generally used in regressive methods, but may also be used progressively both in histology and cytology preparations.

Item	Name	Vol	Qty
SH5777	Harris Optimized	Gal.(3.8L)	EA.
SH4777	Harris Optimized	Liter (1000mL)	EA.
SH3777	Harris Optimized	500mL	EA.
SH5775	Harris Optimized/Acidified	Gal.(3.8L)	EA.
SH4775	Harris Optimized/Acidified	Liter (1000mL)	EA.
SH3775	Harris Optimized/Acidified	500mL	EA.

Gill 1,2,3 Hematoxylin

Generally used in the progressive method.

Item	Name	Vol	Qty
CM4951	Gill1 Optimized	Gal.(3.8L)	EA.
CM4952	Gill1 Optimized	Liter (1000mL)	EA.
CM4953	Gill1 Optimized	500mL	EA.
CM5951	Gill2 Optimized	Gal.(3.8L)	EA.
CM5952	Gill2 Optimized	Liter (1000mL)	EA.
CM5953	Gill2 Optimized	500mL	EA.
CM6951	Gill3 Optimized	Gal.(3.8L)	EA.
CM6952	Gill3 Optimized	Liter (1000mL)	EA.
CM6953	Gill3 Optimized	500mL	EA.



Eosin Y

Eosin Y is an alcohol-based, ready-to-use secondary stain used primarily in histology for routine hematoxylin and eosin staining. CDI's Eosin Y is filtered prior to bottling and is formulated for consistency.

Eosin Y w/Phloxine B

Produces a brighter counter stain.

Scotts Tap Water

Scotts Tap Water substitute is a bluing reagent designed mainly for histology. It blues hematoxylin gently and minimizes loss of tissue sections and cells from glass slides.

Scott's Tap Water Substitute is prepared to supply a gentle but appropriate bluing solution for staining.

This formulation provides rapid and precise bluing of nuclear chromatin and nuclear membranes.

Rinse-HD™, Hematoxylin mucin/background differentiator

Rinse-HD™ is a hematoxylin differentiator used in progressive H&E staining procedures. Rather than removing over-stain, clear mucin is exhibited following differentiation with Rinse-HD™

Acid Alcohol 1%

Acid Alcohol 1% is used in histology and cytology to remove excess stain and define nuclei following hematoxylin staining in the H&E and PAP methods. Acid Alcohol provides the proper amount of differentiation in order to produce a good H&E stain with crisp nuclear detail.



Eosin Y

Item	Vol	Qty
EM000G	Gal. (3.8L)	EA.
EML00G	Liter (1000 mL)	EA.
EM500G	500 mL	EA.

Eosin Y with Phloxine

Item	Vol	Qty
EM00PG	Gal. (3.8L)	EA.
EML0PG	Liter (1000 mL)	EA.
EM50PG	500 mL	EA.

Scott's Tap Water

Item	Vol	Qty
CM4951W	Gal. (3.8L)	EA.

Rinse-HD™, Hematoxylin Differentiator

Item	Vol	Qty
FX2182	Gal. (3.8L)	EA.
FX2183	Gal (3.8L)	CS/4

Acid Alcohol 1%

Item	Vol	Qty
ST0016	Gal. (3.8L)	EA.
ST0017	Gal. (3.8L)	CS/4
ST0018	Liter (1000 mL)	EA.

Dermatoxylin™ and Dermosin™, Skin Hematoxylin & Eosin

CDI's Skin Optimized stain system consists of a special hematoxylin formulation, Dermatoxylin™, and eosin formulation, Dermosin™.

Dermatoxylin™ is a regressive skin hematoxylin optimized for dermatology specimens and is prepared to produce optimum staining in rapid time. Dermatoxylin™ is formulated for routine H&E staining in the Dermatopathology laboratory and is designed to work with Dermosin™ skin eosin, which has the appropriate amount of acid for proper counterstaining of epidermis and dermis.



Dermatoxylin™		
Item	Vol	Qty
ST0015	Gal. (3.8L)	EA.
ST0014	500 mL	EA.

Dermosin™		
Item	Vol	Qty
ST0008	Gal. (3.8L)	EA.
ST0007	500 mL	EA.

3-Stain Dip Kit™ Prefilled 4 Slide Jars (Solutions A-C)		
Item	Description	Qty
3STK-ABC	3 Stain 4 Slide Jar Kit	150 Jars
Packaged in die cut trays		(50 - Solution A) (50 - Solution B) (50 - Solution C)



3-Stain Kit™

A three step procedure for differential staining of blood smears, cytopins and tissue imprints. It is useful in evaluating blood parasites, microbial organisms and bone marrow specimens.

The entire procedure takes 30 seconds as air dried specimens are fixed in Solution A then dipped in Solutions B and C. Staining intensity is easily manipulated. Leukocytes appear crisp and distinct.

Solutions A-C:

Item	Vol	Qty
FX1087	Gal. (3.8L)	EA.
FX1088	Liter (1000mL)	EA.
FX1089	500mL	EA.

Solution A:

Item	Vol	Qty
FX2110	Gal. (3.8L)	EA.
FX2111	Liter (1000mL)	EA.
FX2112	500mL	EA.

Solution B:

Item	Vol	Qty
FX2113	Gal. (3.8L)	EA.
FX2114	Liter (1000mL)	EA.
FX2115	500mL	EA.

Solution C:

Item	Vol	Qty
FX2116	Gal. (3.8L)	EA.
FX2117	Liter (1000mL)	EA.
FX2118	500mL	EA.



FrozenFix™ (Frozen Section Fixative)

FrozenFix™ is formulated for fixation of frozen section tissues. Fixation of frozen sections requires only 5 seconds to support rapid staining with H&E. (Works with all H&E's, but formulated for use with CDI's Cryo-Stains.)

Item	Vol	Qty
ST0009	500 mL	EA.
ST0010	Gal. (3.8L)	EA.

Cryo-Hematoxylin™

Designed for rapid and precise staining of frozen sections and is optimized for Frozen Section Staining. Stains nuclear detail crisply and strongly, and it assures excellent counterstaining by Cryo-Eosin™.

Item	Vol	Qty
ST0012	500 mL	EA.
ST0013	Gal. (3.8L)	EA.

Cryo-Acid Alcohol™

Formulated for frozen sections and is particularly formulated for frozen sections of skin. Cryo-Acid Alcohol™ removes over-staining and non-specific staining rapidly and is optimized for use with Cryo-Hematoxylin™ and Cryo-Eosin™ stain.

Item	Vol	Qty
ST0001	500 mL	EA.
ST0002	Gal. (3.8L)	EA.

Cryo-Bluing™

Formulated for quick, consistent bluing and is optimized for quick staining.

Item	Vol	Qty
ST0003	500 mL	EA.
ST0004	Gal. (3.8L)	EA.

Cryo-Eosin™

Cryo-Eosin™ is balanced at the proper pH and strength designed to stain frozen sections rapidly. Cryo-Eosin™ dehydrates quickly and differentiates rapidly during staining.

Item	Vol	Qty
ST0005	500 mL	EA.
ST0006	Gal. (3.8L)	EA.

Cryo-Kit Frozen Section/ Mohs Stain Kit

Complete kit available, including the 5 frozen section stains- 500 mL each

One of each pictured below

Item	Vol	Qty
ST0011	500 mL x 5	EA.



Gold Chloride, 0.1%

Uses include Reticulum and Gomori Methenamine Silver Nitrate Stain (GMS) stains.

Item	Vol	Qty
SSC1150-250	250 mL	EA.
SSC1150-500	500 mL	EA.

Gold Chloride, 0.2%

Uses include Reticulum and Gomori Methenamine Silver Nitrate Stain (GMS) stains.

Item	Vol	Qty
SSC1080-250	250 mL	EA.
SSC1080-500	500 mL	EA.

Ammonium Hydroxide, 28%

Reagent grade. Concentration is 28%.

Item	Vol	Qty
SSC1045-250	250 mL	EA.
SSC1045-500	500 mL	EA.

Hydrochloric Acid, 31.5%

Reagent grade. Concentration is 31.5%.

Item	Vol	Qty
LR8570	500 mL	EA.

Schiff Reagent

Use in the standard Periodic Acid-Schiff (PAS) reaction for neutral mucosubstances, glycogen, basement membrane and fungal cell walls. A positive reaction produces a purplish red/bright rose color.

Item	Vol	Qty
FX2109	500 mL	EA.

Periodic Acid Solution 1%

A 1% aqueous solution used to oxidize reactive tissue elements to aldehydes prior to treatment with Schiff reagent.

Item	Vol	Qty
FX2108-I	500 mL	EA.

Periodic Acid Solution .5%

A 0.5% aqueous solution used to oxidize reactive tissue elements to aldehydes prior to treatment with Schiff reagent.

Item	Vol	Qty
FX2108	500 mL	EA.

Glacial Acetic Acid

Reagent grade. Concentration is 99.85%.

Item	Vol	Qty
C8551	500 mL	EA.





Alcian Blue, Eosin Y, OG-6 and Hematoxylin Powdered Stains

Alcian Blue Powdered Stain

Item	Vol	Qty
SSI025P	25G	EA.
SSI050P	50G	EA.

Eosin Y Powdered Stain

Item	Vol	Qty
CME025	25G	EA.
CME050	50G	EA.
CME001	Kilo	EA.

OG-6 Powdered Stain

Item	Vol	Qty
CMG025	25G	EA.
CMG050	50G	EA.
CMG001	Kilo	EA.

Hematoxylin Powdered Stain

Item	Vol	Qty
CM7025	25G	EA.
CM7050	50G	EA.
CM0001	Kilo	EA.

Staining Ancillaries



A

D

C

B

E



F

Staining Dishes, Racks and Jars

High-quality flint glass Coplin Jars and Staining Dishes are commonly used for all routine and special staining procedures.

Each dish comes with a separate fitted cover which prevents evaporation and contamination and helps to contain chemical odors.

Each staining dish has corresponding stainless staining rack available which is designed to fit inside.

A Glass Coplin Jars with Glass Lid

Item	Description	Qty
SD1006	Coplin Jar, Glass	PK/5
SD1007	Coplin Jar, Glass	CS/20

B Glass Coplin Jars (Short) with Plastic Lid

Item	Description	Qty
SD1008	Short Coplin Jar, Glass	PK/5

C Plastic Coplin Jars

Item	Description	Qty
SD1005P	Coplin Jar, Plastic	EA.

D Glass Staining Dish

Item	Description	Qty
SD1020	Glass, 20 slide	EA.
SD1030	Glass, 30 slide	EA.
SD1060	Glass, 60 slide	EA.

E Stainless Rack

Item	Description	Qty
SDS1020	20 slides, fits glass staining dish	EA.
SDS1030	30 slides, fits glass staining dish	EA.
SDS1060	60 slides, fits glass staining dish	EA.

F Parafilm™ M, Self-Sealing Flexible Film

Made of a semi-transparent and waterproof material, film is resistant to most acids and alcohols.

Item	Description	Qty
PM992	2" x 250' roll	EA.
MP999	4" x 250' roll	EA.



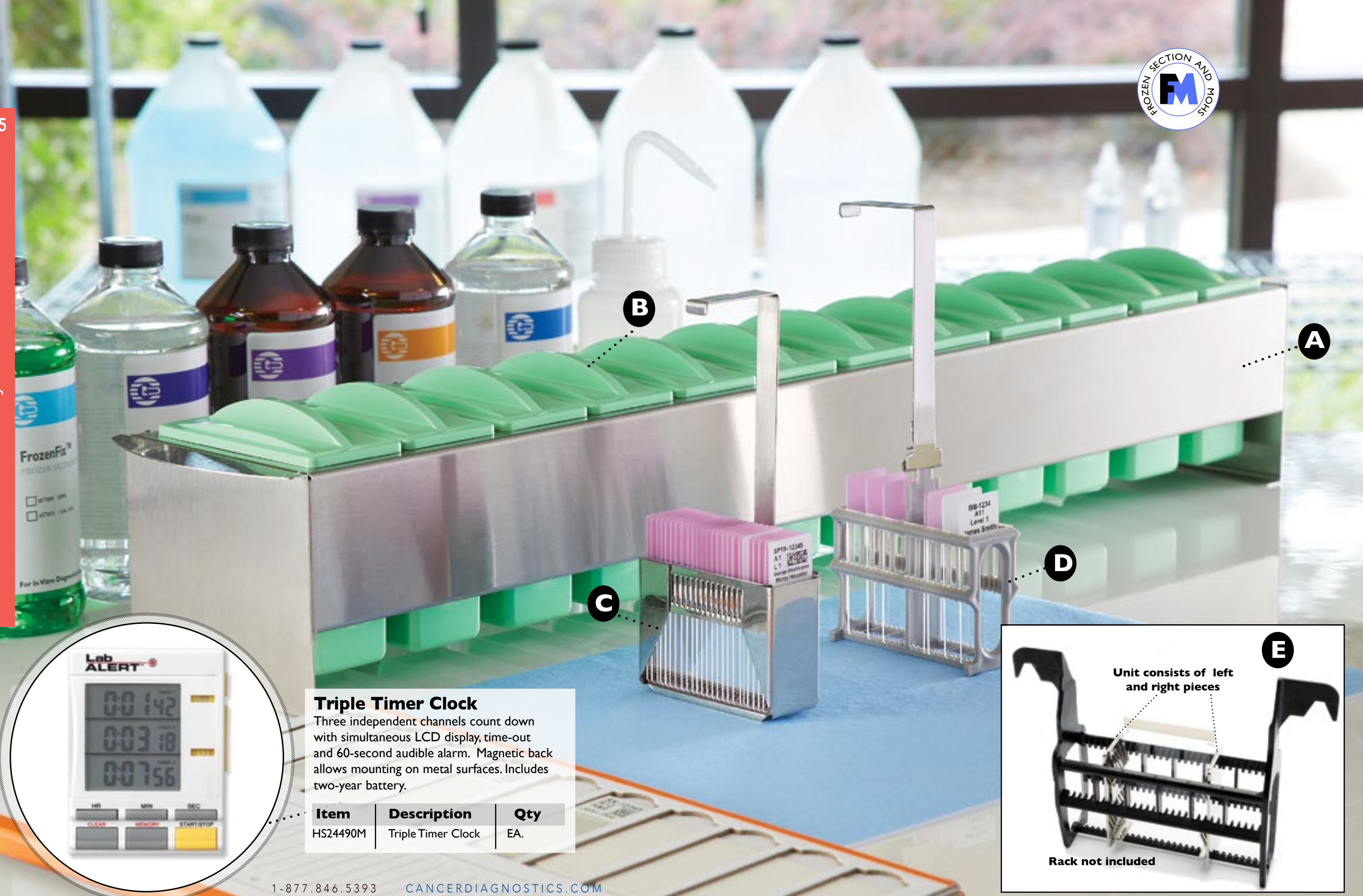

Triple Timer Clock
 Three independent channels count down with simultaneous LCD display, time-out and 60-second audible alarm. Magnetic back allows mounting on metal surfaces. Includes two-year battery.

Item	Description	Qty
HS24490M	Triple Timer Clock	EA.

A 12 Staining Rack (pictured)
 Also available in 3 Staining Rack

Item	Description	Qty
SDSK1012	12 Place Slide Stain Set	EA.
SDSK1003	3 Place Slide Stain Set	EA.

B Plastic Green Staining Dish with Lid

Item	Description	Qty
SDP1003	Green Staining Dish	EA.

C Metal Slide Dipper

Item	Description	Qty
SDS1024	25 Slide Metal Dipper	EA.

D Plastic Slide Dipper

Item	Description	Qty
SDP1025	24 Slide Plastic Dipper	EA.

E Large Slide Adapter (Automated or Manual Staining)

Item	Description	Qty
SDS5075	Large Slide Adapter	Unit

F Leica Staining Dish and Rack

Item	Description	Qty
L30	Rack	EA.
LJ30	Staining Dish	EA.

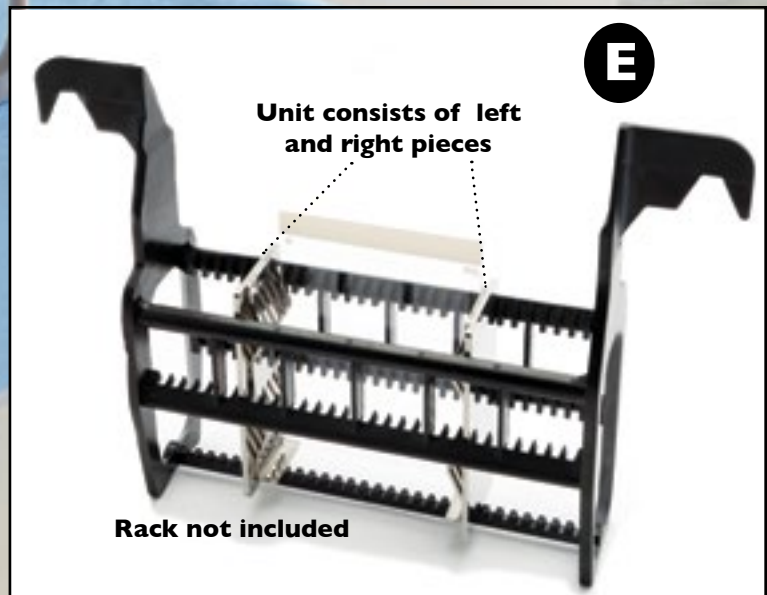

Filtration Papers

247

Stain Systems



Qualitative Cellulose Grade Filter Paper 33cm diameter #6150-3300

Qualitative, Rough surface, 0.25 mm thick with flow rate of 235 mls/min. Filters to 25 microns.

Item	Size	Porosity	Flow Rate	Qty
41311198	33cm	Fine	Fast	PK/100

Fluted Qualitative Cellulose Filter Paper 32cm diameter #5420-3200

Widely used for general purpose filtration. Has excellent particle retention and a good filtration speed and loading capacity. Fluted version maintains a better flow rate due to the reduction in filter paper contact with the funnel side.

Item	Size	Porosity	Flow Rate	Qty
41311196	32cm	Medium	Medium	PK/100

EZ-Spout



EZ-Spout

Easy pour for gallon containers. Reduce splashing and dripping while pouring.

Item	Description	Qty
EPS38-PK	EZ-Spout 1- Gallon	PK/3

Deionized Water



Deionized Water

Reagent ACS grade. For all standard pathology laboratory applications.

Item	Description	Qty
H20004	Gallon	CS/4
H20025	2.5 Gallon	EA.
H20005	5 Gallon	EA.

Graduated Cylinder

248

Stain Systems



Graduated Cylinder

Polypropylene Graduated Cylinder, Blue Printed Graduations 1000 mL Capacity.

Item	Description	Qty
602566	Polypropylene Graduated Cylinder	EA.

Wash Bottles Color Coded

Wash Bottles Safety Labeled



I20245 - White



I20246 - Red



I20247 - Yellow



I20248 - Green



I20249 - Blue

Wash Bottles Color Coded
Color-coded for easy identification.
Leak-proof. The angled neck and tip provide a uniform stream of liquid and the tip can be cut back if required to increase the flow. 500ml bottle size

Item	Description	Qty
I20245	White	PK/6
I20246	Red	PK/6
I20247	Yellow	PK/6
I20248	Green	PK/6
I20249	Blue	PK/6



I20250 - Acetone



I20251 - Distilled Water



I20252 - Isopropanol



I20253 - Ethanol



I20254 - Methanol



I20255 - Sodium Hypochlorite



I20256 - Self Labeling

Wash Bottles Safety Labeled Self-Venting

The information provided on the front of each bottle is specific to the product contained and includes the appropriate corresponding codes and symbols. You also have the option of using other liquids within the bottles and creating the appropriate safety information on the outside of the bottle by using the 'Self Labeling' versions. 500ml bottle size

Item	Description	Qty
I20250	Acetone	PK/6
I20251	Distilled Water	PK/6
I20252	Isopropanol	PK/6
I20253	Ethanol	PK/6
I20254	Methanol	PK/6
I20255	Sodium Hypochlorite	PK/6
I20256	Self Labeling	PK/6
I20257	Assorted (one of each, except Methanol)	PK/6

Pearl™ Pipettes

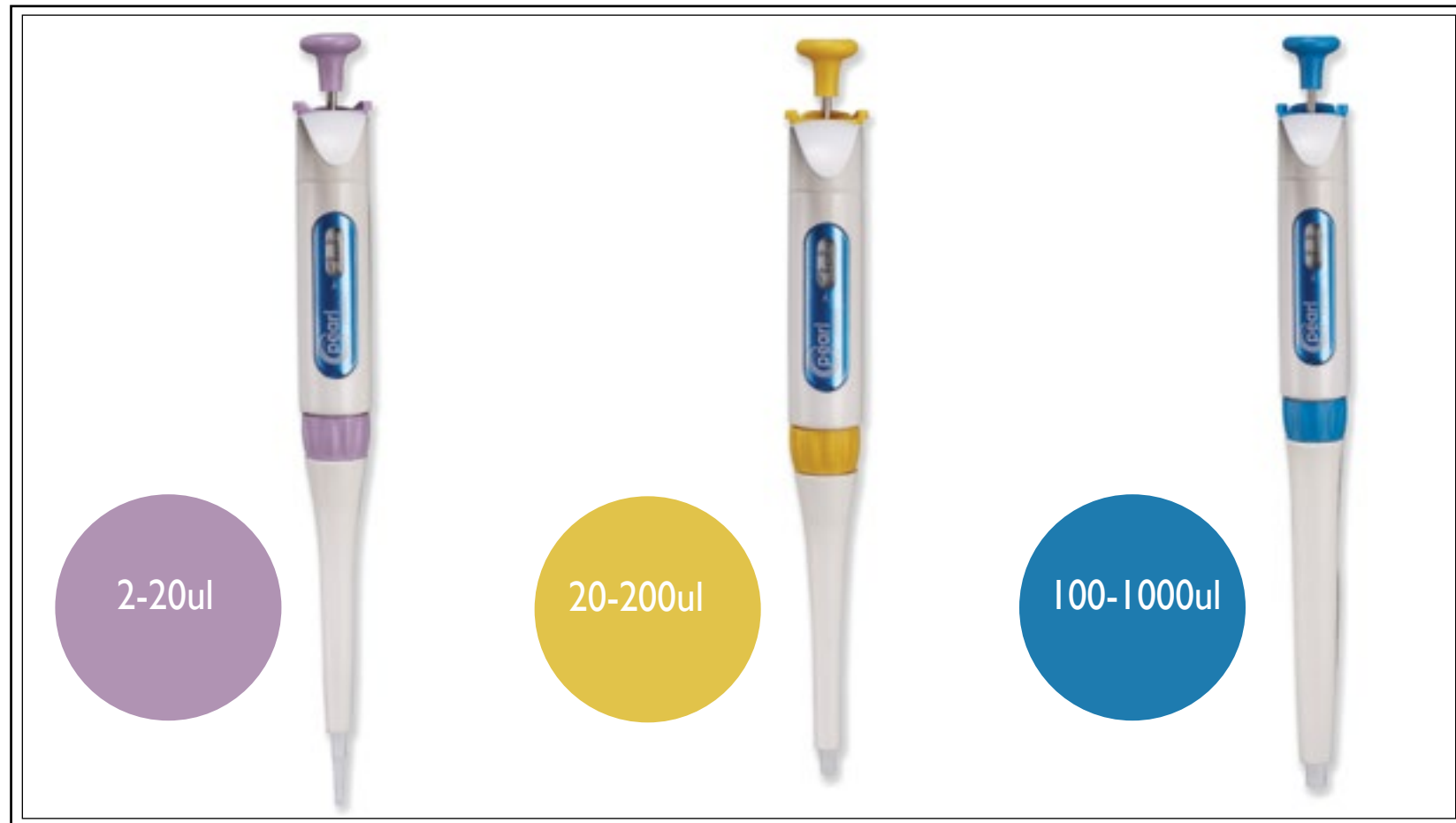

Micro Adjustable Pipettes

Each Pearl™ pipette is built around a precision-engineered internal shaft and tip barrel. The result is increased accuracy and calibration stability, as well as enhanced chemical resistance. The outer shell is constructed from easy-to-clean polypropylene.

The entire unit can be autoclaved.

Pearl™ Adjustable Micro Pipettes. Single channel. Ergonomic design. Adjustable volume.

Item	Description	Qty
HS120099	Light purple, 2-20ul	EA.
HS120102	Yellow, 20-200ul	EA.
HS120104	Blue, 100-1000ul	EA.



Pipette Tips



Universal Pipette Tips

Universal clear pipette tips. Bulk and sterile racked.

- Thin-wall design for great fit and perfect seal everytime
- Certified free from RNase, DNase, DNA and Human DNA

Bulk

Item	Volume	Qty
330-2000	20ul	Bag/1000
340-2000	200ul	Bag/1000
360-2000	1000ul	Bag/1000

Racked

Item	Volume	Qty
340-4050	200ul	CS/960
360-4050	1000ul	CS/960



SPECIAL STAINS

CONVENIENT SPECIAL STAIN KITS, REAGENTS,
AND QUALITY CONTROL SLIDES

Special Stain Kits • Components
Histology Control Slides



Special stains are alternate staining techniques (Chemical reactions between the tissue components and dyes) that are used in situations where H&E cannot provide all the information needed by a pathologist for diagnosis.

Volume-Optimized (-VO) and original Standardized Volume Kits (SVK) Kits

Two kit options are available. The (-VO) kits contain different component volumes, optimized according to the kit's procedure to minimize leftover components. Our original standardized volume kits (SVK) contain component volumes that are the same. These kits are available as 125mL, 250mL, and 500mL kits.

List of Volume Optimized Special Stain Kits

Acid Fast Bacteria (AFB) Stain Kit	SS1000-ZN-VO
Alcian Blue - PAS Stain Kit	SS1002-VO
Alcian Blue pH 1.0 Stain Kit	SS1001-PH1-VO
Alcian Blue pH 2.5 Stain Kit	SS1001-PH25-VO
Amyloid Stain Kit (Congo Red)	SS1003-VO
Bielschowsky's Stain Kit (Modified)	SS1040-VO
Calcium Stain Kit (Modified Von Kossa)	SS1027-VO
Colloidal Iron Stain Kit	SS1006-VO
Copper Stain Kit (For Microwave)	SS1022-M-VO
Elastic Stain Kit (Modified Verhoeff's)	SS1005-VO
Eosinophil-Mast Cell Stain Kit	SS1035-VO
Fite Stain Kit, Leprosy & Nocardia	SS1024-VO
Fontana-Masson Stain Kit (For Argentaffin Cells and Melanin)	SS1020-VO
Giemsa Stain Kit (May-Grunwald)	SS1033-VO
GMS Stain Kit	SS1046-VO
Gram Stain Kit	SS1004-VO
Gram Stain Kit (Modified Brown & Brenn)	SS1004-BB-VO
H. Pylori Rapid Stain Kit	SS1025-VO
Iron Stain Kit	SS1013-VO
Jones Stain Kit (Basement Membrane)	SS1050-VO
Luxol Fast Blue Stain Kit	SS1036-VO
Movat Pentachrome Stain Kit (Modified Russell-Movat)	SS1037-VO
Mucicarmine (Modified Southgate) Stain Kit	SS1009-SG-VO
Oil Red O Stain Kit (For Fat)	SS1048-VO
Orcein Stain Kit (Hepatitis B)	SS1039-VO
Periodic Acid Schiff (PAS) Diastase Stain Kit	SS1010-VO
Periodic Acid Schiff (PAS) Fungus Stain Kit	SS1047-VO
Periodic Acid Schiff (PAS) Stain Kit (Modified Lillie's)	SS1011-VO
Picro-Sirius Red Stain Kit (For Cardiac Muscle)	SS1038-CM-VO
Picro-Sirius Red Stain Kit (For Collagen)	SS1038-VO
Pneumocystis Stain Kit	SS1049-VO
PTAH Stain Kit For Microwave (Phosphotungstic Acid Hematoxylin)	SS1041-VO
Reticulum Stain Kit	SS1042-R-VO
Reticulum Stain Kit (Modified Gomori's)	SS1042-VO
Steiner Stain Kit (Modified Chapman) for Spirochetes	SS1014-MC-VO
Trichrome Stain Kit, Modified Gomori (Green)	SS1026-MG-VO
Trichrome Stain Kit, Modified Masson (Blue)	SS1026-MAB-VO
Twort's Counterstain Kit	SS1043-VO
Warthin-Starry (Modified Stat) Stain Kit	SS1028-VO
Wright- Giemsa Stain Kit	SS1044-VO

Volume Optimized Special Stain Kits

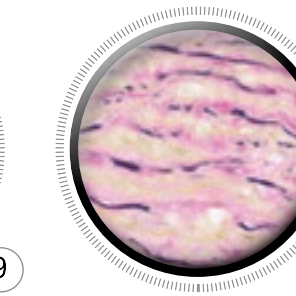
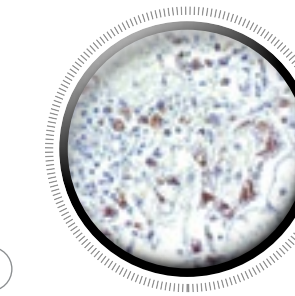
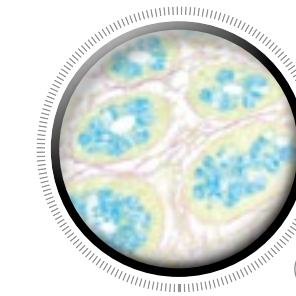
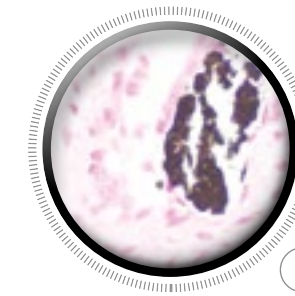
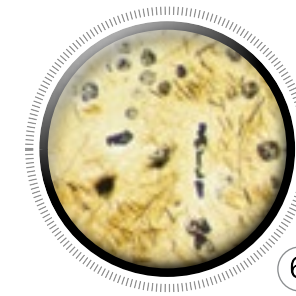
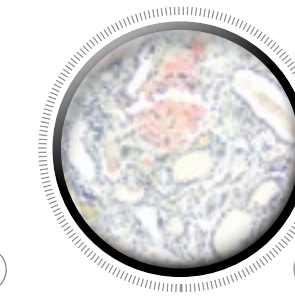
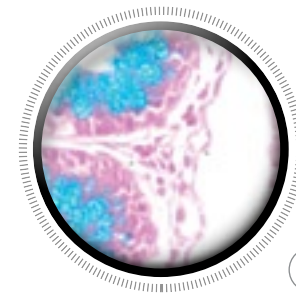
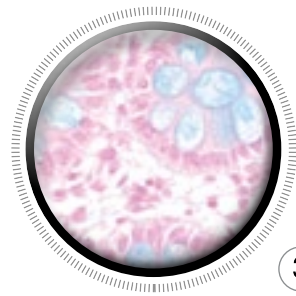
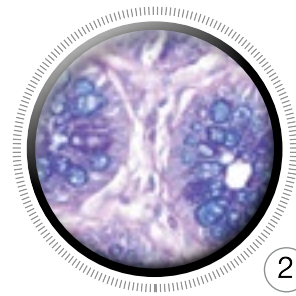
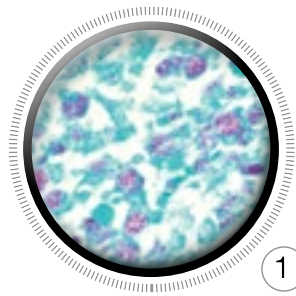

1. Acid Fast Bacteria (AFB) Stain Kit

The Acid Fast Bacteria (AFB) Stain Kit is intended for use in the histological visualization of acid fast bacteria and tubercle bacilli. This kit is a rapid 15-minute procedure. The lipid capsule of the acid-fast organism takes up carbol fuchsin and resists de-colorization.

SS1000-ZN-VO	
Carbol Fuchsin, Ziehl-Neelsen	125mL
Acid Alcohol, 0.5%	500mL
Light Green Counterstain	125mL

2. Alcian Blue PAS Stain Kit

The Alcian Blue - PAS Stain Kit is intended for use in the simultaneous histological visualization of sulfated and carboxylated acid mucopolysaccharides, sulfated and carboxylated sialomucins (glycoproteins) and neutral mucins.

SS1002-VO	
Acetic Acid, 3%	250mL
Alcian Blue Stain pH 2.5	250mL
Periodic Acid, 0.5%	250mL
Schiff Reagent	250mL
Modified Mayer's Hematoxylin	250mL

3. Alcian Blue pH 1.0 Stain Kit

The Alcian Blue (pH 1.0) Stain Kit is intended for use in the histological visualization of strongly sulfated mucosubstances.

SS1001-PH1-VO	
Alcian Blue Stain pH 1.0 Stain	250 mL
Safranin O Stain	250 mL
Acetic Acid, 3%	500 mL

4. Alcian Blue pH 2.5 Stain Kit

The Alcian Blue (pH 2.5) Stain Kit is intended for use in the histological visualization of sulfated and carboxylated acid mucopolysaccharides and sulfated and carboxylated sialomucins (glycoproteins).

SS1001-PH25-VO	
Alcian Blue Stain pH 2.5	250mL
Acetic Acid, 3%	500mL
Safranin O Stain	250mL

5. Amyloid Stain Kit (Congo Red)

The Amyloid Stain Kit (Congo Red) is intended for use in the histological visualization of amyloid in tissue sections. Examination under a polarizing microscope results in green birefringence of amyloid.

SS1003-VO	
Congo Red Stain, Highman	500mL
Modified Mayer's Hematoxylin	500mL
Bluing Reagent	500mL

6. Bielschowsky's Stain Kit (Modified)

Bielschowsky's Stain Kit (Modified) is designed for histological visualization of nerve fibers, neurofibrillary tangles and senile plaques in Alzheimer's disease.

SS1040-VO	
Silver Nitrate, 20%	500mL
Formalin Solution, 20%	8mL
Citric Acid Solution (Bielschowsky's)	8mL
Nitric Acid Solution (Bielschowsky's)	8mL
Sodium Thiosulfate, 5%	125mL

7. Calcium Stain Kit (Modified Von Kossa)

The Calcium Stain Kit (Modified Von Kossa) is intended for use in the histological visualization of calcium deposits in paraffin or frozen section.

SS1027-VO	
Silver Nitrate, 5%	125mL
Sodium Thiosulfate, 5%	125mL
Nuclear Fast Red	125mL

8. Colloidal Iron Stain Kit

The Colloidal Iron Stain Kit is designed for the histological visualization of acid mucopolysaccharides.

SS1006-VO	
Acetic Acid, 12%	500mL
Colloidal Iron Stock Solution	125mL
Hydrochloric Acid, 3%	125mL
Potassium Ferrocyanide, 3%	125mL
Van Gieson's Stain	125mL

9. Copper Stain Kit (For Microwave)

The Copper Stain Kit (For Microwave) is intended for the demonstration of copper deposits in tissue sections.

SS1022-M-VO	
Rhodanine Stain Stock Solution	30mL
Acetate Buffer, pH 8.0	500mL (2)
Modified Mayer's Hematoxylin	125mL

10. Elastic Stain Kit (Modified Verhoeff)

The Elastic Stain Kit is intended for use in histological demonstration of elastin in tissue sections. Demonstration of elastic tissue is useful in cases of emphysema (atrophy of elastic tissue), arteriosclerosis (thinning and loss of elastic fibers) and various other vascular diseases.

SS1005-VO	
Alcoholic Hematoxylin, 5%	250mL
Ferric Chloride, 10%	125mL
Lugol's Iodine Solution	125mL
Ferric Chloride, 2%	125mL
Sodium Thiosulfate, 5%	125mL
Van Gieson's Stain	125mL

Kits in this section are Volume Optimized. Please refer to pages 267-275 for standard 125, 250 & 500 mL versions.

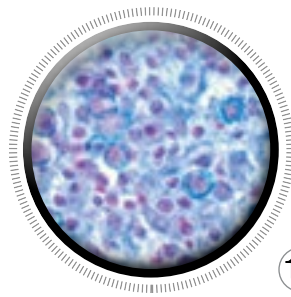

11

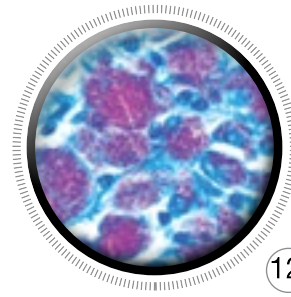

12

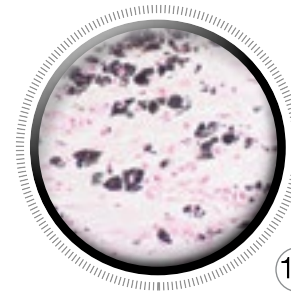

13

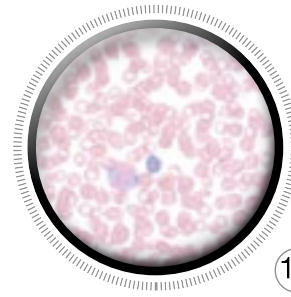

14

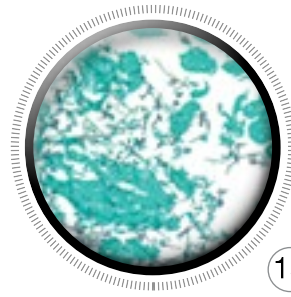

15

11. Eosinophil – Mast Cell Stain Kit

The Eosinophil - Mast Cell Stain Kit is intended for simultaneous visualization of eosinophils and mast cells.

SS1035-VO	
Astra Blue Solution	125 mL
Vital New Red Solution	125 mL
Modified Mayer's Hematoxylin	125 mL

12. Fite Stain Kit, Leprosy & Nocardia

The Fite's Stain Kit is intended for use in the histological visualization of mycobacterium leprae (leprosy).

SS1024-VO	
Xylene-Peanut Oil Solution	125mL
Carbol Fuchsin Stain	125mL
Acid Alcohol, 1%	500mL
Methylene Blue Working Solution	125mL

13. Fontana-Masson Stain Kit (For Argentaffin Cells and Melanin)

SS1020-VO
The Fontana-Masson Stain Kit is intended for use in the histological visualization of argentaffin cells and melanin in paraffin or frozen sections.

Silver Nitrate, 10%	125mL
Gold Chloride, 0.2%	9mL (5)
Sodium Thiosulfate, 5%	125mL
Nuclear Fast Red	125mL

14. Giemsa Stain Kit (May-Grunwald)

The Giemsa Stain Kit is intended for use in the visualization of cells present in hematopoietic tissues and certain microorganisms. This kit may be used on formalin-fixed, paraffin-embedded or frozen sections.

SS1033-VO	
May-Grunwald (Jenner) Solution	500mL
Giemsa Stain Stock Solution	500mL
Giemsa Buffer, pH 6.8	500mL

15. GMS Stain Kit

The Modified Gomori Methenamine-Silver Nitrate Stain (GMS Stain Kit) is intended for use in the histologic visualization of fungi, basement membrane and some opportunistic organisms such as Pneumocystis carinii. Pneumocystis carinii is an opportunistic pathogen that causes severe pulmonary disease in humans, dogs, rats, mice and other vertebrate species with acquired, induced, or inherited immune deficiency syndromes. In addition, this procedure will demonstrate Actinomyces and related species, Nocardia asteroides, and certain encapsulated bacteria.

SS1046-VO	
GMS Methenamine Stock Solution	125mL
GMS Silver Nitrate Stock Solution	125mL
Gold Chloride, 0.2%	125mL
Sodium Borate, 5%	15mL
Sodium Bisulfite, 1%	125mL
Sodium Thiosulfate, 5%	125mL
Chromic Acid, 5%	125mL
Light Green Counterstain	125mL

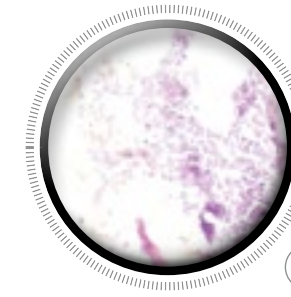

16

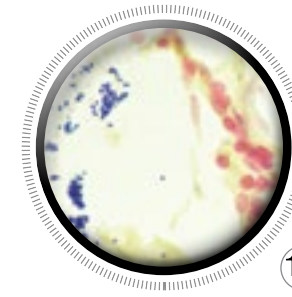

17

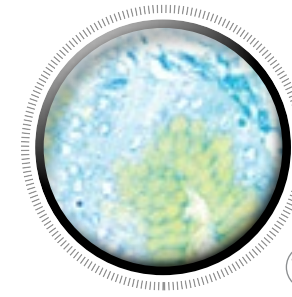

18

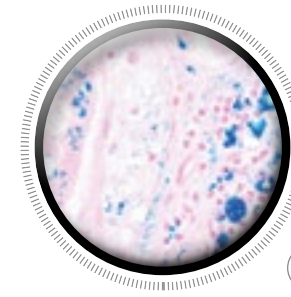

19

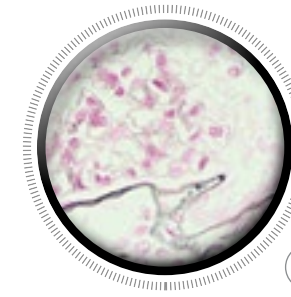

20

16. Gram Stain Kit

The Gram Stain Kit is intended for the demonstration and differentiation of Gram-positive and Gram-negative bacteria. Gram Positive Bacteria: Blue, Gram Negative Bacteria: Red, Other Tissue: Yellow, Nuclei: Red.

SS1004-VO	
Gentian Violet Solution	125mL
Iodine Solution, Lugol	125mL
Gram's Decolorizer Solution	125mL
Carbol Fuchsin Counterstain	125mL
Tartrazine Stain	125mL

17. Gram Stain Kit (Modified Brown & Brenn)

The Gram Stain Kit is intended for the demonstration and differentiation of Gram-positive and Gram-negative bacteria.

SS1004-BB-VO	
Gentian Violet Solution	125mL
Iodine Solution, Lugol	125mL
Gram's Decolorizer Solution	125mL
Safranin O Stain	125mL
Picric Acid-Acetone Solution	125mL

18. H. Pylori Rapid Stain Kit

The H. Pylori Rapid Stain Kit is designed for demonstrating Helicobacter Pylori infected tissue. Kit may be used on formalin fixed, paraffin-embedded tissue as well as frozen sections.

SS1025-VO	
Periodic Acid, 1%	500mL
Alcian Yellow Stain	125mL
Sodium Metabisulfite, 5%	125mL
Toluidine Blue Stock Solution	6mL (2)
Sodium Hydroxide, 3%	8mL

19. Iron Stain Kit

The Iron Stain Kit is intended for use in the detection of ferric iron in tissues, blood smears, or bone marrow smears. Ferric iron is normally found in small amounts in bone marrow and the spleen. Abnormally large deposits may be seen in hemochromatosis and hemosiderosis. This product is based on the Prussian Blue reaction in which ionic iron reacts with acid ferrocyanide producing a blue color.

SS1013-VO	
Potassium Ferrocyanide, 3%	500mL
Hydrochloric Acid, 3%	500mL
Nuclear Fast Red	125mL

20. Jones Stain Kit (Basement Membrane)

The Jones Stain Kit is intended for use in histological demonstration of the basement membrane and reticular fibers. This procedure is ideal for staining renal glomerular basement membranes. The main function of the basement membrane and reticular fibers is to provide anchorage and support. They are normally found throughout the body, particularly in the kidney, spleen, and lung.

SS1050-VO	
Periodic Acid, 0.5%	250mL
Methenamine, 3%	250mL (2)
Silver Nitrate, 5%	30mL
Sodium Borate, 5%	125mL
Gold Chloride, 0.2%	125mL
Sodium Thiosulfate, 5%	125mL
Nuclear Fast Red	125mL

Kits in this section are Volume Optimized. Please refer to pages 267-275 for standard 125, 250 & 500 mL versions.



21. Luxol Fast Blue Stain Kit

The Luxol Fast Blue Stain Kit is designed for staining myelin/myelinated axons and Nissl substance on formalin fixed, paraffin-embedded tissue as well as frozen tissue. This product is used for identifying the basic neuronal structure in brain or spinal cord sections.

SS1036-VO	
Luxol Fast Blue, 0.1%	125mL
Cresyl Echt Violet, 0.1%	125mL
Lithium Carbonate, 0.05%	500mL
Ethyl Alcohol, 70%	500mL

22. Movat Pentachrome Stain Kit (Modified Russell-Movat)

The Movat Pentachrome Stain Kit is intended for use in histological demonstration of collagen, elastin, muscle, mucin and fibrin in tissue sections. This procedure is particularly useful when studying the heart, blood vessels and various vascular diseases.

SS1037-VO	
Alcoholic Hematoxylin, 5%	250mL
Ferric Chloride, 10%	125mL
Iodine Solution	125mL
Ferric Chloride, 2%	125mL
Sodium Thiosulfate, 5%	125mL
Acetic Acid, 3%	125mL
Acetic Acid, 1%	250mL
Alcian Blue, pH 2.5	125mL
Biebrich Scarlet-Acid Fuchsin Stain	125mL
Phosphotungstic Acid, 5%	125mL
Tartrazine Stain	125mL

Kits in this section are Volume Optimized. Please refer to pages 267-275 for standard 125, 250 & 500 mL versions.

23. Mucicarmine (Modified Southgate) Stain Kit

Mucicarmine Stain Kit is intended for use in the histological visualization of acid mucopolysaccharides in tissue sections. This product is useful in distinguishing mucin negative undifferentiated squamous cell lesions from mucin positive adenocarcinomas. In addition, this product will stain the mucopolysaccharide capsule of *Cryptococcus neoformans*.

SS1009-SG-VO	
Modified Mayer's Hematoxylin	125mL
Bluing Reagent	125mL
Mucicarmine Stock Solution	125mL
Tartrazine Stain	125mL

24. Oil Red O Stain Kit (For Fat)

Oil Red O Stain Kit is intended for use in the histological visualization of fat cells and neutral fat. This kit may be used ONLY on frozen tissue sections, fresh smears, or touch preps.

SS1048-VO	
Propylene Glycol, 100%	500mL
Oil Red O Stain	125mL
Modified Mayer's Hematoxylin	125mL

25. Orcein Stain Kit (Hepatitis B)

The Hepatitis B Stain Kit is intended for use in the histological visualization of Hepatitis B surface antigen (HBsAg). This kit may be used on formalin-fixed, paraffin-embedded or frozen sections.

SS1039-VO	
Potassium Permanganate, 5%	30mL
Sulfuric Acid, 3%	30mL
Oxalic Acid, 2%	125mL
Orcein Solution	125mL
Acid Alcohol, 1%	125mL

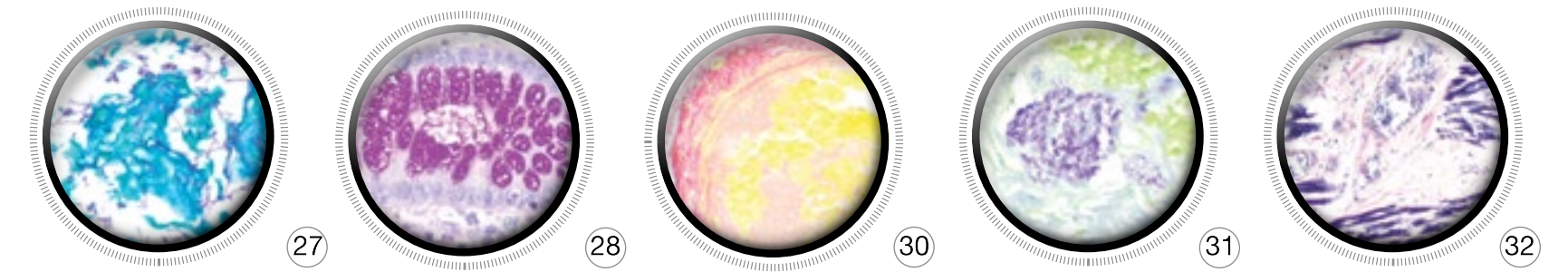

26. Periodic Acid Schiff (PAS) Diastase Stain Kit

Basically the same description as the normal PAS with the addition of something like this: The digestion step included in this kit, breaks down glycogen into smaller sugars allowing for the comparison of digested and undigested slides.

SS1010-VO (NOT PICTURED)	
Diastase Solution	125mL
Periodic Acid, 1%	250mL
Schiff Reagent	250mL
Modified Mayer's Hematoxylin	125mL
Bluing Reagent	125mL

27. Periodic Acid Schiff (PAS) Fungus Stain Kit

The Periodic Acid Schiff (PAS) for Fungus Stain Kit is intended for use in histological demonstration of fungal organisms in tissue sections. The PAS reaction is also useful in the demonstration of lymphocytes and mucopolysaccharides. The staining patterns of the lymphocytes are helpful in making therapeutic decisions in established cases of lymphocytic leukemia.

SS1047-VO	
Periodic Acid, 1%	250mL
Schiff Reagent	250mL
Light Green Counterstain	125mL

28. Periodic Acid Schiff (PAS) Stain Kit (Modified Lillie's)

The Periodic Acid Schiff (PAS) Stain Kit is intended for use in histological demonstration of lymphocytes and mucopolysaccharides. The staining pattern of the lymphocytes is helpful in making therapeutic decisions in established cases of lymphocytic leukemia. The PAS reaction in tissue sections is useful for the demonstration of mucopolysaccharides. PAS staining may also be used for the demonstration of fungal organisms in tissue sections.

SS1011-VO	
Periodic Acid, 1%	250mL
Schiff Reagent	250mL
Modified Mayer's Hematoxylin	125mL
Bluing Reagent	125mL

29. Picro-Sirius Red Stain Kit (For Cardiac Muscle)

The Cardiac modification of the PRS Stain eliminates the yellow staining of the muscle fibers and cytoplasmic background. This allows for thin collagenous septa to be more easily distinguished and may also be viewed under polarized light to produce birefringence of the collagen fibers.

SS1038-CM-VO (NOT PICTURED)	
Phosphomolybdic Acid, 0.2%	250mL
Picro-Sirius Red Solution	250mL
Acetic Acid, 0.5%	250mL

30. Picro-Sirius Red Stain Kit (For Collagen)

The PRS Stain is intended for use in staining of collagen, and with the incorporation of an iron hematoxylin nuclear stain, maybe used in place of Van Gieson's staining procedures. The Picro-Sirius Red primary stain produces red collagen and yellow muscle and cytoplasmic staining. When used, iron hematoxylin produces black nuclei. Sections stained in the PRS may also be viewed under polarized light to produce birefringence of the collagen fibers.

SS1038-VO	
Picro-Sirius Red Solution	250mL
Acetic Acid, 0.5%	250mL

31. Pneumocystis Stain Kit

The Pneumocystis Stain Kit is intended for use in the histological visualization of Pneumocystis in cytology smears, and paraffin or frozen tissue sections.

SS1049-VO	
Cresyl Echt Violet, 0.1%	125mL
Naphthol Yellow S Stain	125mL
Staining Jar	60mL

32. PTAH Stain Kit for Microwave (Phosphotungstic Acid Hematoxylin)

The PTAH Stain Kit for Microwave is intended for use in the histological visualization of collagen, striated muscle, glial fibers and collagen without using Zenker's Fixative with Mercuric Chloride as a mordant. This kit may be used on formalin-fixed, paraffin-embedded or frozen sections.

SS1041-VO	
Zinc Chloride Solution (PTAH)	500mL
Ferric Ammonium Sulfate, 5%	125mL
Phosphotungstic Acid Hematoxylin (PTAH) Stain	125mL

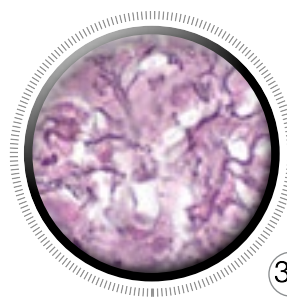

34



35

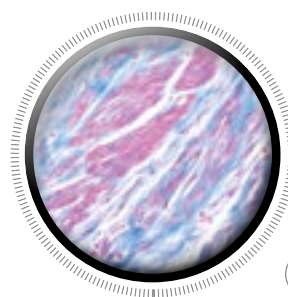

36

33. Reticulum Stain Kit

The Reticulum Stain Kit is intended for use in histological demonstration of reticular fibers. The main function of reticular fibers is to provide support. They are normally found throughout the body, particularly in liver, lymph node, spleen and kidney. Ammoniacal silver stains are the most commonly used methods for demonstration of reticular fibers.

SS1042-R-VO (NOT PICTURED)

Potassium Permanganate, 1%	125mL
Potassium Metabisulfite, 3%	125mL
Ferric Ammonium Sulfate, 3%	125mL
Formalin Solution, 20%	125mL
Gold Chloride, 0.1%	125mL
Sodium Thiosulfate, 5%	125mL
Nuclear Fast Red	125mL
Sodium Hydroxide, 3%	125mL
Silver Nitrate, 10%	10mL (5)

34. Reticulum Stain Kit (Modified Gomori's)

The Reticulum Stain Kit (Modified Gomori's) is intended for use in histological demonstration of reticular fibers. The main function of reticular fibers is to provide support. They are normally found throughout the body, particularly in liver, lymph node, spleen and kidney. Ammoniacal silver stains are the most commonly used methods for demonstration of reticular fibers.

SS1042-VO

Potassium Permanganate, 0.5%	125mL
Sulfuric Acid Solution (1N)	15mL
Potassium Metabisulfite, 3%	125mL
Ferric Ammonium Sulfate, 2%	125mL
Silver Nitrate, 10%	60mL
Potassium Hydroxide, 10%	15mL
Formalin Solution, 20%	125mL
Gold Chloride, 0.2%	125mL
Sodium Thiosulfate, 5%	125mL
Nuclear Fast Red	125mL

35. Steiner Stain Kit (Modified Chapman) for Spirochetes

The Steiner Stain Kit, Modified Chapman (For Spirochetes) is designed for demonstrating fungi, Helicobacter Pylori, Legionella pneumophila, and Spirochete infected tissue. Kit may be used on formalin fixed, paraffin- embedded tissue as well as frozen sections.

SS1014-MC-VO

Oxidizer Solution, Steiner	125mL
Zinc Formalin, 10%	125mL
Silver Nitrate, 0.2%	125mL
Silver Nitrate, 1%	15mL
Gum Mastic, 2.5%	125mL
Hydroquinone Powder	0.5g (5)

36. Trichrome Stain Kit, Modified Gomori (Green)

The Trichrome Stain Kit (Modified Gomori) is intended for use in the histological visualization of collagenous connective tissue fibers in tissue sections. The Gomori Trichrome is a more simplified procedure than other more traditional trichromes. Additionally, this procedure is useful in the assessment of the degree of fibrosis in liver biopsies.

SS1026-MG-VO

Bouin's Solution	125mL
Iron Hematoxylin, Solution A	125mL
Iron Hematoxylin, Solution B	125mL
Gomori Trichrome Stain, Green	125mL
Acid Alcohol, 0.5%	250mL
Acetic Acid, 0.5%	250mL

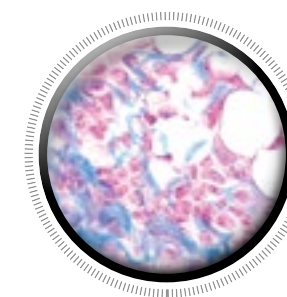

37

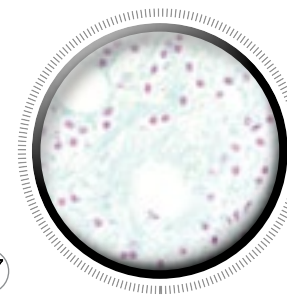

38

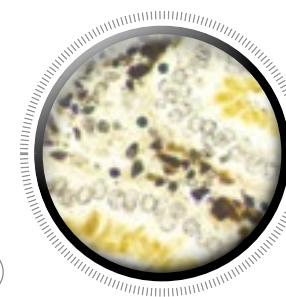

39

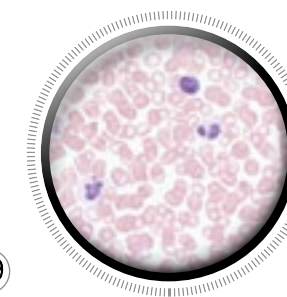

40

37. Trichrome Stain Kit Modified Masson (Blue)

The Trichrome Stain Kit (Modified Masson) is intended for use in histology laboratories for the staining and subsequent visualization of collagenous connective tissue fibers in tissue sections. This Trichrome Special Stain kit may be used on formalin-fixed, paraffin-embedded or frozen sections.

SS1026-MAB-VO

Bouin's Solution	125mL
Iron Hematoxylin, Solution A	125mL
Iron Hematoxylin, Solution B	125mL
Biebrich Scarlet-Acid Fuchsin Stain	125mL
Acid Alcohol, 1%	125mL
Aniline Blue Stain	125mL
Acetic Acid, 1%	125mL

38. Twort's Counterstain Kit

The Twort's Counterstain Kit is intended for use in histology procedures such as the Gram Stain to provide contrast for easier visualization of various cell components in tissue sections.

SS1043-VO

Twort's Counterstain, Solution A (Red)	125mL
Twort's Counterstain, Solution B (Green)	30mL
Acetic Acid-Alcohol, 2%	250mL

39. Warthin-Starry (Modified Stat) Stain Kit

The Warthin-Starry Stain Kit is intended for use in the visualization of Spirochetes, Helicobacter pylori, Legionella pneumophila, and Cat Scratch Fever bacteria. This kit may be used on formalin-fixed, paraffin-embedded or frozen sections.

SS1028-VO

Spirochete Prep Solution	125mL
Silver Nitrate, 0.5%, Acidulated	125mL
Gelatin Solution, 4%, Acidulated	125mL
Silver Nitrate, 2%, Acidulated	15mL
Hydroquinone Solution, Acidulated	60mL

40. Wright-Giemsa Stain Kit

Wright-Giemsa Stain Kit is intended to be used for differential staining of blood smears, bone marrow and blood parasites.

SS1044-VO

Wright-Giemsa Stain	500mL
Giemsa Buffer, pH 6.8	500mL (2)

Kits in this section are Volume Optimized. Please refer to pages 267-275 for standard 125, 250 & 500 mL versions.

Special Stain Components

Special Stain Components

265

Name	250mL	500mL	Storage	Expiration	Name	250mL	500mL	Storage	Expiration
Acetic Acid 1%	SSC1031-250	SSC1031-500	20°-25°C	24 months	Congo Red Stain, Highman	SSC1065-250	SSC1065-500	20°-25°C	12 months
Acetate Buffer, pH 5.6	SSC1269-250	SSC1269-500	20°-25°C	12 months	Congo Red Stock Solution, Puchtler	SSC1063-250	SSC1063-500	20°-25°C	12 months
Acetate Buffer, pH 8.0	SSC1220-250	SSC1220-500	20°-25°C	12 months	Cresyl Echt Violet, 0.1%	SSC1068-250	SSC1068-500	20°-25°C	12 months
Acetic Acid-Alcohol Solution (SAB)	SSC1221-250	SSC1221-500	20°-25°C	24 months	Cresyl Echt Violet, 1%, Aqueous	SSC1233-250	SSC1233-500	20°-25°C	12 months
Acetic Acid-Alcohol, 2%	SSC1222-250	SSC1222-500	20°-25°C	24 months	Crocein Scarlet-Acid Fuchsin Stain	SSC1272-250	SSC1272-500	20°-25°C	12 months
Acetic Acid, 0.5%	SSC1030-250	SSC1030-500	20°-25°C	24 months	Crystal Scarlet (MSB) Stain	SSC1234-250	SSC1234-500	20°-25°C	12 months
Acetic Acid, 10%	SSC1223-250	SSC1223-500	20°-25°C	24 months	Crystal Violet Stock Solution	SSC1066-250	SSC1066-500	20°-25°C	12 months
Acetic Acid, 12%	SSC1032-250	SSC1032-500	20°-25°C	24 months	Crystal Violet-Oxalate Stain	SSC1146-250	SSC1146-500	20°-25°C	12 months
Acetic Acid, 2%	SSC1224-250	SSC1224-500	20°-25°C	24 months	Crystal Violet, 1%	SSC1067-250	SSC1067-500	20°-25°C	12 months
Acetic Acid, 25%	SSC1225-250	SSC1225-500	20°-25°C	24 months	Diastase Solution	SSC1058-250	SSC1058-500	2°-8°C	12 months
Acetic Acid, 3%	SSC1033-250	SSC1033-500	20°-25°C	24 months	Diastase, 25G	SSC1139-25G-250	SSC1139-25G-500	20°-25°C	24 months
Acetic Acid, 40%	SSC1034-250	SSC1034-500	20°-25°C	24 months	Eriochrome Black T Stain	SSC1069-250	SSC1069-500	20°-25°C	12 months
Acetic Acid, 99%	SSC1226-250	SSC1226-500	20°-25°C	24 months	Fast Green Counterstain	SSC1160-250	SSC1160-500	20°-25°C	12 months
Acetone	SSC1192-250	SSC1192-500	20°-25°C	24 months	Fast Green, 1%	SSC1235-250	SSC1235-500	20°-25°C	12 months
Acetone-Alcohol Solution	SSC1163-250	SSC1163-500	20°-25°C	24 months	Ferric Ammonium Sulfate, 2.5%	SSC1072-2.5-250	SSC1072-2.5-500	20°-25°C	24 months
Acetone-Xylene Solution	SSC1193-250	SSC1193-500	20°-25°C	24 months	Ferric Ammonium Sulfate, 2%	SSC1159-2-250	SSC1159-2-500	20°-25°C	24 months
Acid Alcohol, 0.5%	SSC1035-250	SSC1035-500	20°-25°C	24 months	Ferric Ammonium Sulfate, 3%	SSC1275-250	SSC1275-500	20°-25°C	24 months
Acid Alcohol, 1%	SSC1036-250	SSC1036-500	20°-25°C	24 months	Ferric Ammonium Sulfate, 5%	SSC1236-250	SSC1236-500	20°-25°C	24 months
Acid Water 1%	SSC1038-250	SSC1038-500	20°-25°C	24 months	Ferric Chloride, 1%	SSC1237-250	SSC1237-500	20°-25°C	24 months
Acidulated Water, pH 4.0	SSC1210-250	SSC1210-500	20°-25°C	12 months	Ferric Chloride, 10%	SSC1073-250	SSC1073-500	20°-25°C	24 months
Alcian Blue Stain pH 1.0	SSC1039-250	SSC1039-500	20°-25°C	12 months	Ferric Chloride, 2%	SSC1203-250	SSC1203-500	20°-25°C	24 months
Alcian Blue Stain pH 2.5	SSC1040-250	SSC1040-500	20°-25°C	12 months	Formalin Solution, 10%	SSC1074-250	SSC1074-500	20°-25°C	24 months
Alcian Blue, 1% Alcoholic	SSC1227-250	SSC1227-500	20°-25°C	12 months	Formalin Solution, 2%	SSC1277-250	SSC1277-500	20°-25°C	24 months
Alcian Yellow Stain	SSC1041-250	SSC1041-500	20°-25°C	12 months	Formalin Solution, 20%	SSC1161-250	SSC1161-500	20°-25°C	24 months
Alcoholic Hematoxylin, 5%	SSC1042-250	SSC1042-500	20°-25°C	12 months	Fouchet's Reagent	SSC1076-250	SSC1076-500	20°-25°C	24 months
Alcoholic Saffron Solution	SSC1228-250	SSC1228-500	20°-25°C	12 months	Gallego Solution	SSC1077-250	SSC1077-500	20°-25°C	24 months
Alcoholic Sodium Chloride Solution	SSC1043-250	SSC1043-500	20°-25°C	24 months	Gelatin Solution, 4%, Acidulated	SSC1165-250	SSC1165-500	2°-8°C	12 months
Aldehyde Fuchsin Stain	SSC1141-250	SSC1141-500	2°-8°C	12 months	Gelatin Solution, 5%, Acidulated	SSC1273-250	SSC1273-500	2°-8°C	12 months
Alkaline-Alcohol Solution	SSC1044-250	SSC1044-500	20°-25°C	24 months	Gentian Violet Solution	SSC1166-250	SSC1166-500	20°-25°C	12 months
Ammonium Hydroxide, 28%	SSC1045-250	SSC1045-500	20°-25°C	24 months	Giemsa Buffer, pH 6.8	SSC1145-250	SSC1145-500	20°-25°C	24 months
Ammonium Hydroxide, 3%	SSC1229-250	SSC1229-500	20°-25°C	24 months	Giemsa Stain Stock Solution	SSC1164-250	SSC1164-500	20°-25°C	12 months
Amyloid Pretreatment Solution	SSC1046-250	SSC1046-500	20°-25°C	24 months	GMS Methenamine Stock Solution	SSC1204-250	SSC1204-500	2°-8°C	12 months
Amyloid Stain, Crystal Violet	SS1003-C-250	SS1003-C-500	20°-25°C	12 months	GMS Silver Nitrate Stock Solution	SSC1240-250	SSC1240-500	2°-8°C	12 months
Aniline Blue (MSB) Stain	SSC1230-250	SSC1230-500	20°-25°C	12 months	Gold Chloride, 0.1%	SSC1150-250	SSC1150-500	2°-8°C	12 months
Aniline Blue Stain	SSC1048-250	SSC1048-500	20°-25°C	12 months	Gold Chloride, 0.2%	SSC1080-250	SSC1080-500	2°-8°C	12 months
Auramine O Phenol Stain	SSC1232-250	SSC1232-500	20°-25°C	12 months	Gomori Trichrome Stain, Green	SSC1082-250	SSC1082-500	20°-25°C	12 months
Auramine O-Rhodamine Stain	SSC1049-250	SSC1049-500	2°-8°C	12 months	Gram's Decolorizer Solution	SSC1163-250	SSC1163-500	20°-25°C	24 months
Basic Fuchsin, 0.25%	SSC1051-250	SSC1051-500	20°-25°C	12 months	Gum Mastic, 2.5%	SSC1083-250	SSC1083-500	2°-8°C	24 months
Biebrich Scarlet-Acid Fuchsin Stain	SSC1052-250	SSC1052-500	20°-25°C	12 months	Hydrochloric Acid, 2%	SSC1084-250	SSC1084-500	20°-25°C	24 months
Bluing Reagent	SSC1152-250	SSC1152-500	20°-25°C	24 months	Hydrochloric Acid, 20%	SSC1085-250	SSC1085-500	20°-25°C	24 months
Bouin's Solution	SSC1053-250	SSC1053-500	20°-25°C	24 months	Hydrochloric Acid, 3%	SSC1086-250	SSC1086-500	20°-25°C	24 months
Carbol Fuchsin Counterstain	SSC1196-250	SSC1196-500	20°-25°C	12 months	Hydroquinone Powder	SSC1088-5G	SSC1088-5G	20°-25°C	24 months
Carbol Fuchsin Counterstain (Gram's)	SSC1055-250	SSC1055-500	20°-25°C	12 months	Hydroquinone Solution, Acidulated	SSC1087-250	SSC1087-500	2°-8°C	12 months
Carbol Fuchsin, Kinyoun	SSC1054-250	SSC1054-500	20°-25°C	12 months	Hydroquinone, 2%	SSC1270-250	SSC1270-500	2°-8°C	12 months
Carbol Fuchsin, Ziehl-Neelsen	SSC1055-ZN-250	SSC1055-ZN-500	20°-25°C	12 months	Iodine Solution, Gram	SSC1089-250	SSC1089-500	20°-25°C	24 months
Chromic Acid Solution, ~10%	SSC1156-250	SSC1156-500	20°-25°C	24 months	Iodine Solution, Lugol's	SSC1090-250	SSC1090-500	20°-25°C	24 months
Chromic Acid, 4%	SSC1140-250	SSC1140-500	20°-25°C	24 months	Iodine Solution, Weigert & Lugol	SSC1274-250	SSC1274-500	20°-25°C	12 months
Chromic Acid, 5%	SSC1056-250	SSC1056-500	20°-25°C	24 months	Iron Hematoxylin Stain Kit (Sol. A&B)	SSC1241-250	SSC1241-500	20°-25°C	12 months
Citric Acid Solution (Bielschowsky)	SSC1200-250	SSC1200-500	20°-25°C	12 months	Iron Hematoxylin, Solution A	SSC1060-250	SSC1060-500	20°-25°C	12 months
Colloidal Iron Stock Solution	SSC1062-250	SSC1062-500	20°-25°C	12 months	Iron Hematoxylin, Solution B	SSC1061-250	SSC1061-500	20°-25°C	12 months
Congo Red Solution, Amyloid Stain	SSC1157-250	SSC1157-500	20°-25°C	12 months	Light Green Counterstain	SSC1091-250	SSC1091-500	20°-25°C	12 months
Congo Red Stain, Benhold	SSC1064-250	SSC1064-500	20°-25°C	12 months	Light Green Stain (Masson)	SSC1242-250	SSC1242-500	20°-25°C	12 months
Congo Red Stain, PureView™	SSC1057-250	SSC1057-500	20°-25°C	12 months	Light Green Stock Solution	SSC1093-250	SSC1093-500	20°-25°C	12 months

SPECIAL STAINS CONTROL SLIDES

266

Name	250mL	500mL	Storage	Expiration	Name	250mL	500mL	Storage	Expiration
Lithium Carbonate, 0.05%	SSC2101-250	SSC2101-500	20°-25°C	24 months	Rhodanine Stain Stock Solution	SSC1116-250	SSC1116-500	2°-8°C	12 months
Lithium Carbonate, 1%	SSC1243-250	SSC1243-500	20°-25°C	24 months	Safranin O Stain	SSC1188-250	SSC1188-500	20°-25°C	12 months
Luxol Fast Blue, 0.1%	SSC2102-250	SSC2102-500	20°-25°C	12 months	Schiff Reagent	SSC1117-250	FX2109	2°-8°C	12 months
Malaria Stain, Thick Preparation, Solution A	SSC1244-250	SSC1244-500	20°-25°C	12 months	Silver Nitrate, 0.1%	SSC1268-250	SSC1268-500	2°-8°C	12 months
Malaria Stain, Thick Preparation, Solution B	SSC1245-250	SSC1245-500	20°-25°C	12 months	Silver Nitrate, 0.2%	SSC1187-250	SSC1187-500	2°-8°C	18 months
Malaria Stain, Thin Preparation	SSC1246-250	SSC1246-500	20°-25°C	12 months	Silver Nitrate, 0.5%, Acidulated	SSC1186-250	SSC1186-500	2°-8°C	12 months
Martius Yellow (MSB) Stain	SSC1247-250	SSC1247-500	20°-25°C	12 months	Silver Nitrate, 1%	SSC1120-250	SSC1120-500	2°-8°C	12 months
May Grunwald (Jenner) Solution	SSC1179-250	SSC1179-500	20°-25°C	12 months	Silver Nitrate, 1%, Acidulated	SSC1118-250	SSC1118-500	2°-8°C	12 months
Mayers PureView Hematoxylin	SSC1059-250	SSC1059-500	20°-25°C	12 months	Silver Nitrate, 10%	SSC1121-250	SSC1121-500	2°-8°C	12 months
Mentanil Yellow Stain, .25%	SSC1094-250	SSC1094-500	20°-25°C	12 months	Silver Nitrate, 2%, Acidulated	SSC1119-250	SSC1119-500	2°-8°C	12 months
Methenamine Silver Stock Solution	SSC1095-250	SSC1095-500	2°-8°C	6 months	Silver Nitrate, 20%	SSC1199-250	SSC1199-500	2°-8°C	12 months
Methenamine, 3%	SSC1248-250	SSC1248-500	2°-8°C	12 months	Silver Nitrate, 5%	SSC1122-250	SSC1122-500	2°-8°C	12 months
Methylene Blue Working Solution	SSC1096-250	SSC1096-500	20°-25°C	12 months	Sodium Bisulfite, 1%	SSC1185-250	SSC1185-500	20°-25°C	24 months
Modified Mayer's Hematoxylin	SSC1059-250	SSC1059-500	20°-25°C	12 months	Sodium Borate (Saturated), Alcoholic	SSC1261-250	SSC1261-500	20°-25°C	24 months
Mucicarmine Stock Solution	SSC1098-250	SSC1098-500	2°-8°C	12 months	Sodium Borate Solution	SSC1126-250	SSC1126-500	20°-25°C	24 months
Nitric Acid Solution (Bielschowsky's)	SSC1201-250	SSC1201-500	20°-25°C	12 months	Sodium Borate, 0.5%	SSC1125-250	SSC1125-500	20°-25°C	24 months
Nuclear Fast Red	SSC1099-250	SSC1099-500	20°-25°C	12 months	Sodium Borate, 5%	SSC1126-250	SSC1126-500	20°-25°C	24 months
Oil Red O Stain	SSC1100-250	SSC1100-500	20°-25°C	12 months	Sodium Carbonate Solution	SSC1276-250	SSC1276-500	20°-25°C	24 months
One Step Trichrome Stain, Blue	SSC1081-250	SSC1081-500	20°-25°C	12 months	Sodium Hydroxide, 1%	SSC1127-250	SSC1127-500	20°-25°C	24 months
One Step Trichrome Stain, Green	SSC1082-250	SSC1082-500	20°-25°C	12 months	Sodium Hydroxide, 3%	SSC1128-250	SSC1128-500	20°-25°C	24 months
Orcein Solution	SSC1250-250	SSC1250-500	20°-25°C	12 months	Sodium Metabisulfite, 5%	SSC1129-250	SSC1129-500	20°-25°C	24 months
Oxalic Acid, 1%	SSC1101-250	SSC1101-500	20°-25°C	24 months	Sodium Sulfate, 0.5%	SSC1262-250	SSC1262-500	20°-25°C	24 months
Oxalic Acid, 2%	SSC1251-250	SSC1251-500	20°-25°C	24 months	Sodium Sulfite, 5%	SSC1271-250	SSC1271-500	20°-25°C	24 months
Oxalic Acid, 5%	SSC1252-250	SSC1252-500	20°-25°C	24 months	Sodium Thiosulfate, 2%	SSC1130-250	SSC1130-500	20°-25°C	24 months
Oxidizer Solution, Steiner	SSC1278-250	SSC1278-500	20°-25°C	24 months	Sodium Thiosulfate, 5%	SSC1131-250	SSC1131-500	20°-25°C	24 months
Periodic Acid, 0.5%	SSC1102-250	FX2108	20°-25°C	24 months	Spirochete Sensitizing Solution	SSC1263-250	SSC1263-500	20°-25°C	24 months
Periodic Acid, 1%	SSC1103-250	FX2108-1	20°-25°C	24 months	Steiner Sensitizer Solution (Chapman's)	SSC1137-250	SSC1137-500	20°-25°C	24 months
Periodic Acid, 10%	FX2108-10P-250	FX2108-10P-500	20°-25°C	24 months	Sudan Black B Stain	SSC1132-250	SSC1132-500	20°-25°C	12 months
Phosphotungstic Acid, 1%	SSC1253-250	SSC1253-250	20°-25°C	24 months	Tartrazine Stain	SSC1190-250	SSC1190-500	20°-25°C	12 months
Phosphomolybdic Acid, 0.2%	SSC1198-250	SSC1198-250	20°-25°C	24 months	Toluidine Blue Stock Solution	SSC1133-250	SSC1133-500	20°-25°C	12 months
Phosphotungstic Acid Hematoxylin (PTAH) Stain	SSC-PTAH-250	SSC-PTAH-500	20°-25°C	12 months	Twort's Counterstain, Solution A (RED)	SSC1147-250	SSC1147-500	20°-25°C	12 months
Phosphotungstic Acid, 2% Alcoholic	SSC1254-250	SSC1254-500	2°-8°C	24 months	Twort's Counterstain, Solution B (Green)	SSC1148-250	SSC1148-500	20°-25°C	12 months
Phosphotungstic Acid, 5%	SSC1181-250	SSC1181-500	20°-25°C	24 months	Uranyl Nitrate, 1%	SSC1134-250	SSC1134-500	20°-25°C	12 months
Phosphotungstic-Phosphomolybdic Acid	SSC1104-250	SSC1104-500	20°-25°C	24 months	Van Gieson's Stain	SSC1135-250	SSC1135-500	20°-25°C	12 months
Picric Acid-Acetone Solution	SSC1255-250	SSC1255-500	20°-25°C	24 months	Wright-Giemsa Stain	SSC1191-250	SSC1191-500	20°-25°C	24 months
Picric Acid-Acetone Solution, 0.1%	SSC1106-250	SSC1106-500	20°-25°C	24 months	Xylene-Peanut Oil Solution	SSC1136-250	SSC1136-500	20°-25°C	24 months
Picric Acid, 2.5% Alcoholic	SSC1256-250	SSC1256-500	20°-25°C	24 months	Zenker's Fixative, Modified (Mercury Free)	SSC1266-250	SSC1266-500	20°-25°C	24 months
Picro-Sirius Red Solution	SSC1197-250	SSC1197-500	20°-25°C	12 months	Zinc Chloride Solution (PTAH)	SSC1267-250	SSC1267-500	20°-25°C	24 months
Potassium Ferrocyanide, 1%	SSC1257-250	SSC1257-500	20°-25°C	24 months					

List of Special Stain Kits (125, 250 and 500 mL)

Name	125 mL	250 mL	500 mL
* Acid Fast Bacteria (Rapid AFB) Stain Kit, PureView™	SS1000-RPD-125	SS1000-RPD-250	SS1000-RPD-500
* Acid Fast Bacteria (AFB) Stain Kit, Light Green	SS1000-LG-125	SS1000-LG-250	SS1000-LG-500
Acid Fast Bacteria (AFB) Stain Kit, Ellis-Zabrowarny	SS1000-EZ-125	SS1000-EZ-250	SS1000-EZ-500
Acid Fast Bacteria (AFB) Stain Kit, Kinyoun	SS1000-KY-125	SS1000-KY-250	SS1000-KY-500
Acid Fast Bacteria (AFB) Stain Kit, Modified Truant's Fluorescent	SS1000-MT-125	SS1000-MT-250	SS1000-MT-500
Acid Fast Bacteria (AFB) Stain Kit, Ziehl-Neelsen	SS1000-ZN-125	SS1000-ZN-250	SS1000-ZN-500
Alcian Blue - PAS Stain Kit	SS1002-125	SS1002-250	SS1002-500
Alcian Blue pH 1.0 Stain Kit	SS1001-PH1-125	SS1001-PH1-250	SS1001-PH1-500
Alcian Blue pH 2.5 Stain Kit	SS1001-PH2-125	SS1001-PH2-250	SS1001-PH2-500
* Amyloid Stain, Crystal Violet	SS1003-C-125	SS1003-C-250	SS1003-C-500
Amyloid Stain Kit, Congo Red, PureView™	SS1003-PV-125	SS1003-PV-250	SS1003-PV-500
Amyloid Stain Kit, Congo Red, Benhold	SS1003-B-125	SS1003-B-250	SS1003-B-500
Amyloid Stain Kit, Congo Red, Highman	SS1003-H-125	SS1003-H-250	SS1003-H-500
Amyloid Stain Kit, Congo Red, Puchtler	SS1003-P-125	SS1003-P-250	SS1003-P-500
Argentaffin Stain Kit, Fontana-Masson	SS1020-125	SS1020-250	SS1020-500
* Bielschowsky's Stain Kit	SS1040-125	SS1040-250	SS1040-500
Bile Stain Kit	SS1016-125	SS1016-250	SS1016-500
Calcium (Modified Von Kossa) Stain Kit	SS1027-125	SS1027-250	SS1027-500
* Colloidal Iron (Modified Hale's) Stain Kit	SS1006-MH-125	SS1006-MH-250	SS1006-MH-500
Colloidal Iron (Muller-Mowry) Stain Kit	SS1006-MM-125	SS1006-MM-250	SS1006-MM-500
Copper (Microwave) Stain Kit	SS1022-M-125	SS1022-M-250	SS1022-M-500
Copper Stain Kit, Rhodanine	SS1022-125	SS1022-250	SS1022-500
Elastic (Modified Verhoeff's) Stain Kit	SS1005-MV-125	SS1005-MV-250	SS1005-MV-500
* Fat Stain Kit, Oil Red O	SS1024-OR-125	SS1024-OR-250	SS1024-OR-500
Fat Stain Kit, Sudan Black B	SS1024-SB-125	SS1024-SB-250	SS1024-SB-500
* Feulgen Stain Kit	SS1045-125	SS1045-250	SS1045-500
Fite Stain Kit, Leprosy	SS1024-L-125	SS1024-L-250	SS1024-L-500
Fite Stain Kit, Nocardia	SS1024-N-125	SS1024-N-250	SS1024-N-500
* Fungus Stain Kit, Gridley	SS1051-125	SS1051-250	SS1051-500
GMS Fungus Stain Kit, Modified	SS1008-125	SS1008-250	SS1008-500
* GMS Stain Kit	SS1052-125	SS1052-250	SS1052-500
* Grimelius (Conventional) Stain Kit	SS1053-125	SS1053-250	SS1053-500
* Grimelius (Microwave) Stain Kit	SS1053-M-125	SS1053-M-250	SS1053-M-500
Gram Stain Kit, Brown-Brenn, Modified	SS1004-BB-125	SS1004-BB-250	SS1004-BB-500
Gram Stain Kit, Brown-Hopps Modified	SS1004-BH-125	SS1004-BH-250	SS1004-BH-500
* Gram Stain Kit, Hucker-Twort	SS1054-125	SS1054-250	SS1054-500
* Gram (Modified) Stain Kit	SS1004-125	SS1004-250	SS1004-500
* Gram (Traditional) Stain Kit	SS1004-T-125	SS1004-T-250	SS1004-T-500
H. Pylori Stain Kit	SS1025-125	SS1025-250	SS1025-500
* Iron Stain Kit, PureView™	SS1013-PV-125	SS1013-PV-250	SS1013-PV-500
Iron Stain Kit, Gomori	SS1013-125	SS1013-250	SS1013-500
* Jones Stain Kit (Basement Membranes)	SS1034-125	SS1034-250	SS1034-500
* Luxol Fast Blue-Cresyl Echt Violet Stain Kit	SS1036-125	SS1036-250	SS1036-500
* Malaria Stain Kit, PureView™	SS1055-125	SS1055-250	SS1055-500

List of Special Stain Kits (125, 250 and 500 mL)

Name	125 mL	250 mL	500 mL
* Martius Scarlet Blue (MSB) Stain Kit	SS1056-125	SS1056-250	SS1056-500
* May-Grunwald Giemsa Stain Kit	SS1033-125	SS1033-250	SS1033-500
* Mucicarmine (Modified Southgate) Stain Kit	SS1060-MS-125	SS1060-MS-250	SS1060-MS-500
Mucicarmine (Classic Southgate) Stain Kit	SS1060-125	SS1060-250	SS1060-500
* Pentachrome Stain Kit, Movat-Russell	SS1037-125	SS1037-250	SS1037-500
* Pentachrome Stain Kit, Modified Movat-Russell	SS1137-125	SS1137-250	SS1137-500
* Periodic Acid Schiff (PAS) Diastase (Powder) Kit	SS1011-DP-125	SS1011-DP-250	SS1011-DP-500
* Periodic Acid Schiff (PAS) Diastase (Solution) Stain Kit	SS1011-DS-125	SS1011-DS-250	SS1011-DS-500
* Periodic Acid Schiff (PAS) Fungus Stain Kit	SS1011-F-125	SS1011-F-250	SS1011-F-500
Periodic Acid Schiff (PAS) Stain Kit	SS1011-125	SS1011-250	SS1011-500
* Phosphotungstic Acid Hematoxylin (Classic PTAH) Stain Kit	SS1041-CL-125	SS1041-CL-250	SS1041-CL-500
* Phosphotungstic Acid Hematoxylin (Improved PTAH) Stain Kit	SS1041-125	SS1041-250	SS1041-500
* Reticulum Stain Kit, PureView™	SS1012-PV-125	SS1012-PV-250	SS1012-PV-500
* Reticulum Stain Kit, Gomori	SS1012-GM-125	SS1012-GM-250	SS1012-GM-500
Reticulum Stain Kit, Gordon & Sweets	SS1012-GS-125	SS1012-GS-250	SS1012-GS-500
* Reticulum Stain Kit, Gordon & Sweets, Modified	SS1012-GSM-125	SS1012-GSM-250	SS1012-GSM-500
* Sevier-Munger Stain Kit	SS1061-125	SS1061-250	SS1061-500
* Schmorl's Melanin Stain Kit	SS1062-125	SS1062-250	SS1062-500
* Sulfated Alcian Blue (SAB) Amyloid Stain Kit	SS1003-SAB-125	SS1003-SAB-250	SS1003-SAB-500
* Steiner Stain Kit, PureView™	SS1014-PV-125	SS1014-PV-250	SS1014-PV-500
Steiner-Steiner Stain Kit	SS1014-125	SS1014-250	SS1014-500
Steiner (Uranyl Nitrate Free), Stain Kit, Modified Chapmans	SS1014-MC-125	SS1014-MC-250	SS1014-MC-500
Trichrome Stain Kit, Gomori One Step, Aniline Blue	SS1026-GAB-125	SS1026-GAB-250	SS1026-GAB-500
Trichrome Stain Kit, Gomori One Step, Light Green	SS1026-GLG-125	SS1026-GLG-250	SS1026-GLG-500
Trichrome Stain Kit, Masson, Aniline Blue	SS1026-MAB-125	SS1026-MAB-250	SS1026-MAB-500
* Trichrome Stain Kit, Masson, Light Green	SS1026-MLG-125	SS1026-MLG-250	SS1026-MLG-500
* Trichrome Stain Kit, McLetchie, Aniline Blue	SS1026-MCAB-125	SS1026-MCAB-250	SS1026-MCAB-500
* Trichrome Stain Kit, McLetchie, Light Green	SS1026-MCLG-125	SS1026-MCLG-250	SS1026-MCLG-500
* Twort's Counterstain Kit	SS1043-125	SS1043-250	SS1043-500
Warthin-Starry Stain Kit	SS1028-125	SS1028-250	SS1028-500
* Warthin-Starry (Modified Stat) Stain Kit	SS1028-M-125	SS1028-M-250	SS1028-M-500

* Kits available but not listed in the following section. Full information online.

The following Special Stain Kits are CDI's® 125 ml, 250 mL & 500 mL kits (Individual components listed under kit descriptions)

AFB Stain Kit, Ellis-Zabrowarny

The **Modified Ellis-Zabrowarny AFB Stain Kit** utilizes **Pureview-Fuchsin™** (phenol free), a carbol fuchsin based primary stain which does not contain phenol. This kit is formulated to provide less exposure to hazardous reagents and produces similar results to the Ziehl-Neelsen modification. Acid fast organisms appear red against a light blue background.

Number	Description	UOM	Case Quantity
SS1000-EZ-125	AFB Stain Kit, Ellis-Zabrowarny	125mL	1
SS1000-EZ-250	AFB Stain Kit, Ellis-Zabrowarny	250mL	1
SS1000-EZ-500	AFB Stain Kit, Ellis-Zabrowarny	500mL	1

Components	250mL	500mL
Pureview-Fuchsin™ (phenol free)	SSC1138-250	SSC1138-500
Acid Alcohol, 1%	SSC1036-250	SSC1036-500
Methylene Blue Working Solution	SSC1096-250	SSC1096-500

Recommended Control	Number
Acid Fast Bacteria	HCS1002

AFB Stain Kit, Kinyoun

Carbol Fuchsin based AFB Stains are used to identify the presence of acid fast bacteria in tissue sections. This kit utilizes the **Kinyoun** modification producing bright red stained acid fast bacteria contrasted by a light blue background.

Number	Description	UOM	Case Quantity
SS1000-KY-125	AFB Stain Kit, Kinyoun	125mL	1
SS1000-KY-250	AFB Stain Kit, Kinyoun	250mL	1
SS1000-KY-500	AFB Stain Kit, Kinyoun	500mL	1

Components	250mL	500mL
Carbol Fuchsin, Kinyoun	SSC1054-250	SSC1054-500
Acid Alcohol, 1%	SSC1036-250	SSC1036-500
Methylene Blue Working Solution	SSC1096-250	SSC1096-500

Recommended Control	Number
Acid Fast Bacteria	HCS1002

AFB Stain Kit, Modified Truant's Fluorescent

The **Modified Truant's AFB Stain** identifies the presence of acid fast bacteria in tissue sections utilizing fluorescent microscopy. Acid fast organisms appear fluorescent yellow to orange against a black background.

Number	Description	UOM	Case Quantity
SS1000-MT-125	AFB Stain Kit, Modified Truant's FL	125mL	1
SS1000-MT-250	AFB Stain Kit, Modified Truant's FL	250mL	1
SS1000-MT-500	AFB Stain Kit, Modified Truant's FL	500mL	1

Components	250mL	500mL
Auramine O-Rhodamine B Stain	SSC1049-250	SSC1049-500
Acid Alcohol, 0.5%	SSC1035-250	SSC1035-500
Eriochrome Black T Stain	SSC1069-250	SSC1069-500

Recommended Control	Number
Acid Fast Bacteria	HCS1002

AFB Stain Kit, Ziehl-Neelsen

Carbol Fuchsin based AFB Stains are used to identify the presence of acid fast bacteria in tissue sections. This kit utilizes the **Ziehl-Neelsen** modification producing bright red stained acid fast bacteria contrasted by a light blue background.

Number	Description	UOM	Case Quantity
SS1000-ZN-125	AFB Stain Kit, Ziehl-Neelsen	125mL	1
SS1000-ZN-250	AFB Stain Kit, Ziehl-Neelsen	250mL	1
SS1000-ZN-500	AFB Stain Kit, Ziehl-Neelsen	500mL	1

Components	250mL	500mL
Carbol Fuchsin, Ziehl-Neelsen	SSC1055-ZN-250	SSC1055-ZN-500
Acid Alcohol, 1%	SSC1036-250	SSC1036-500
Methylene Blue Working Solution	SSC1096-250	SSC1096-500

Recommended Control	Number
Acid Fast Bacteria	HCS1002

Alcian Blue pH 1.0 Stain Kit

Alcian Blue Stains are used for staining acid mucosubstances and acetic mucins. This kit utilizes an **Alcian Blue** solution formulated with a **pH of 1.0**. Acid mucins and mucosubstances appear vibrant blue while Nuclear Fast Red counterstains nuclei pink to red.

Number	Description	UOM	Case Quantity
SS1001-PH1-125	Alcian Blue pH 1.0 Stain Kit	125mL	1
SS1001-PH1-250	Alcian Blue pH 1.0 Stain Kit	250mL	1
SS1001-PH1-500	Alcian Blue pH 1.0 Stain Kit	500mL	1

Components	250mL	500mL
Alcian Blue, pH 1.0	SSC1039-250	SSC1039-500
Acetic Acid, 3%	SSC1033-250	SSC1033-500
Nuclear Fast Red	SSC1099-250	SSC1099-500

Recommended Control	Number
Alcian Blue	HCS1004

Alcian Blue pH 2.5 Stain Kit

Alcian Blue Stains are used for staining acid mucosubstances and acetic mucins. This kit utilizes an **Alcian Blue** solution formulated with a **pH of 2.5**. Acid mucins and mucosubstances appear vibrant blue while Nuclear Fast Red counterstains nuclei pink to red.

Number	Description	UOM	Case Quantity
SS1001-PH2-125	Alcian Blue pH 2.5 Stain Kit	125mL	1
SS1001-PH2-250	Alcian Blue pH 2.5 Stain Kit	250mL	1
SS1001-PH2-500	Alcian Blue pH 2.5 Stain Kit	500mL	1

Components	250mL	500mL
Alcian Blue, pH 2.5	SSC1040-250	SSC1040-500
Acetic Acid, 3%	SSC1033-250	SSC1033-500
Nuclear Fast Red	SSC1099-250	SSC1099-500

Recommended Control	Number
Alcian Blue	HCS1004

Alcian Blue/PAS Stain Kit

Alcian Blue/PAS Stains are used to identify and differentiate neutral and acetic mucosubstances, primarily used on GI tissues. Our **Alcian Blue/PAS Stain Kit** produces distinct staining, neutral polysaccharides appear magenta to pink while acid mucosubstances appear blue.

Number	Description	UOM	Case Quantity
SS1002-125	Alcian Blue/PAS Stain Kit	125mL	1
SS1002-250	Alcian Blue/PAS Stain Kit	250mL	1
SS1002-500	Alcian Blue/PAS Stain Kit	500mL	1

Components	250mL	500mL
Acetic Acid, 3%	SSC1033-250	SSC1033-500
Alcian Blue, pH 2.5	SSC1040-250	SSC1040-500
Periodic Acid, 0.5%	SSC1102-250	FX2108
Schiff Reagent	SSC1117-250	FX2109
PureView™ Mayer's Hematoxylin	SSC1059-250	SSC1059-500

Recommended Control	Number
PAS	HCS1018

Amyloid Stain Kit (PureView™), Congo Red

Congo Red based Amyloid Stains are metachromatic stains used to detect amyloid proteins in tissue. Our **PureView™ Amyloid Stain Kit** is based on the Puchtler modification with **PureView™ Iron Hematoxylin** used as the nuclear stain. **PureView™ Iron Hematoxylin** produces well-delineated nuclei but does not suppress staining of amyloid deposits by the Congo Red. A pre-treatment solution prior to Congo Red intensifies the results by reducing background birefringence. Amyloid appear pink to red and an apple-green color when viewed with polarized microscopy.

Number	Description	UOM	Case Quantity
SS1003-PV-125	PureView™ Amyloid Stain Kit Congo Red	125mL	1
SS1003-PV-250	PureView™ Amyloid Stain Kit Congo Red	250mL	1
SS1003-PV-500	PureView™ Amyloid Stain Kit Congo Red	500mL	1

Components	250mL	500mL
PureView™ Iron Hematoxylin, Solution A	SSC1060-250	SSC1060-500
PureView™ Iron Hematoxylin, Solution B	SSC1061-250	SSC1061-500
Amyloid Pretreatment Solution	SSC1046-250	SSC1046-500
PureView™ Congo Red	SSC1057-250	SSC1057-500

Recommended Control	Number
Amyloid	HCS1005

CDI's Special Stain Kits may be purchased as a complete kit or as individual components ordered in 250mL and 500mL sizes.

Other formulations available, please inquire.

Amyloid Stain Kit, Congo Red, Bennhold

Congo Red based Amyloid Stains are metachromatic stains used to detect amyloid proteins in tissue. This kit utilizes the **Bennhold** modification. Amyloid appear pink to red and an apple-green color when viewed with polarized microscopy.

Number	Description	UOM	Case Quantity
SS1003-B-125	Amyloid Stain Kit, Congo Red, Bennhold	125mL	1
SS1003-B-250	Amyloid Stain Kit, Congo Red, Bennhold	250mL	1
SS1003-B-500	Amyloid Stain Kit, Congo Red, Bennhold	500mL	1

Components	250mL	500mL
Congo Red, Bennhold	SSC1064-250	SSC1064-500
Alkaline-Alcohol Solution	SSC1044-250	SSC1044-500
PureView™ Mayer's Hematoxylin	SSC1059-250	SSC1059-500

Recommended Control	Number
Amyloid	HCS1005

Amyloid Stain Kit, Congo Red, Highman

Congo Red based Amyloid Stains are metachromatic stains used to detect amyloid proteins in tissues. This kit utilizes the **Highman** modification. Amyloid appear orange to red and an apple-green color when viewed with polarized microscopy.

Number	Description	UOM	Case Quantity
SS1003-H-125	Amyloid Stain Kit, Congo Red, Highman	125mL	1
SS1003-H-250	Amyloid Stain Kit, Congo Red, Highman	250mL	1
SS1003-H-500	Amyloid Stain Kit, Congo Red, Highman	500mL	1

Components	250mL	500mL
Congo Red, Highman	SSC1065-250	SSC1065-500
Alkaline-Alcohol Solution	SSC1044-250	SSC1044-500
PureView™ Mayer's Hematoxylin	SSC1059-250	SSC1059-500

Recommended Control	Number
Amyloid	HCS1005

Amyloid Stain Kit, Congo Red, Puchtler

Congo Red based Amyloid Stains are metachromatic stains used to detect amyloid proteins in tissue. This kit utilizes the **Puchtler** modification. A pretreatment solution prior to Congo Red intensifies the results by reducing background birefringence. Amyloid appear pink to red and an apple-green color when viewed with polarized microscopy.

Number	Description	UOM	Case Quantity
SS1003-P-125	Amyloid Stain Kit, Congo Red, Puchtler	125mL	1
SS1003-P-250	Amyloid Stain Kit, Congo Red, Puchtler	250mL	1
SS1003-P-500	Amyloid Stain Kit, Congo Red, Puchtler	500mL	1

Components	250mL	500mL
PureView™ Mayer's Hematoxylin	SSC1059-250	SSC1059-500
Alcoholic Sodium Chloride Solution	SSC1043-250	SSC1043-500
Sodium Hydroxide, 1%	SSC1127-250	SSC1127-500
Congo Red Stock Solution, Puchtler	SSC1063-250	SSC1063-500

Recommended Control	Number
Amyloid	HCS1005

Bile Stain Kit, Hall

Hall's method for the staining of bile uses the oxidizing action of **Fouchet's Reagent** to convert the bile pigment to an easily identifiable green biliverdin. Bile pigments appear green against a yellow background. Collagen appears pink to red.

Number	Description	UOM	Case Quantity
SS1016-125	Bile Stain Kit, Hall	125mL	1
SS1016-250	Bile Stain Kit, Hall	250mL	1
SS1016-500	Bile Stain Kit, Hall	500mL	1

Components	250mL	500mL
Fouchet's Reagent	SSC1076-250	SSC1076-500
Van Gieson's Stain	SSC1135-250	SSC1135-500

Recommended Control	Number
Bile	HCS1008

Colloidal Iron Stain Kit, Müller-Mowry

The **Müller-Mowry Colloidal Iron Stain Kit** is used to demonstrate carboxylated and sulfated mucopolysaccharides and glycoproteins. Acid mucopolysaccharides and sialomucins are stained deep blue and cytoplasm pink, while nuclei appear pink to red.

Number	Description	UOM	Case Quantity
SS1006-MM-125	Colloidal Iron Stain Kit, Müller-Mowry	125mL	1
SS1006-MM-250	Colloidal Iron Stain Kit, Müller-Mowry	250mL	1
SS1006-MM-500	Colloidal Iron Stain Kit, Müller-Mowry	500mL	1

Components	250mL	500mL
Acetic Acid, 12%	SSC1032-250	SSC1032-500
Colloidal Iron Stock Solution	SSC1062-250	SSC1062-500
Acetic Acid, 40%	SSC1034-250	SSC1034-500
Potassium Ferrocyanide, 2%	SSC1108-250	SSC1108-500
Hydrochloric Acid, 2%	SSC1084-250	SSC1084-500
Nuclear Fast Red	SSC1099-250	SSC1099-500

Recommended Control	Number
Mucin	HCS1017

Copper Stain Kit, Rhodanine

This kit uses **Rhodanine** as the primary stain for the demonstration of copper in tissue. This traditional method produces light blue nuclei with bright to yellow-red cytoplasmic copper granules.

Number	Description	UOM	Case Quantity
SS1022-125	Copper Stain Kit, Rhodanine	125mL	1
SS1022-250	Copper Stain Kit, Rhodanine	250mL	1
SS1022-500	Copper Stain Kit, Rhodanine	500mL	1

Components	250mL	500mL
Rhodanine Stock Solution	SSC1116-250	SSC1116-500
Mayer's PureView™ Hematoxylin	SSC1059-250	SSC1059-500
Sodium Borate, 0.5%	SSC1125-250	SSC1125-500

Recommended Control	Number
Section containing copper	N/A

Elastic Stain Kit, Modified Verhoeff

The **Verhoeff's Elastic Stain Kit** demonstrates changes in elastic fibers. Tissues are overstained using Verhoeff's working hematoxylin solution and countered by Van Gieson's. Elastic fibers and nuclei are stained blue to black, collagen is stained red, while other tissues stain yellow.

Number	Description	UOM	Case Quantity
SS1005-MV-125	Elastic Stain Kit, Verhoeff	125mL	1
SS1005-MV-250	Elastic Stain Kit, Verhoeff	250mL	1
SS1005-MV-500	Elastic Stain Kit, Verhoeff	500mL	1

Components	250mL	500mL
Alcoholic Hematoxylin, 5%	SSC1042-250	SSC1042-500
Ferric Chloride, 10%	SSC1073-250	SSC1073-500
Iodine Solution, Lugol	SSC1090-250	SSC1090-500
Sodium Thiosulfate, 5%	SSC1131-250	SSC1131-500
Van Gieson's Stain	SSC1135-250	SSC1135-500
Ferric Chloride, 2%	SSC1203-250	SSC1203-500

Recommended Control	Number
Elastic	HCS1010

Fat Stain Kit, Sudan Black B

The **Sudan Black B** method is used for the demonstration of lipids in fresh tissue sections. Similar to Oil Red O, Sudan Black B is highly soluble in neutral fats; however, it will also combine with acidic groups in compound lipids due to its slightly basic nature. The effect of this is the additional staining of phospholipids. Nuclei are stained red while fat cells are stained blue-black.

Number	Description	UOM	Case Quantity
SS1024-SB-125	Fat Stain Kit, Sudan Black B	125mL	1
SS1024-SB-250	Fat Stain Kit, Sudan Black B	250mL	1
SS1024-SB-500	Fat Stain Kit, Sudan Black B	500mL	1

Components	250mL	500mL
Propylene Glycol, 100%	SSC1114-250	SSC1114-500
Sudan Black B Stain	SSC1132-250	SSC1132-500
Propylene Glycol, 85%	SSC1115-250	SSC1115-500
Nuclear Fast Red	SSC1099-250	SSC1099-500

Recommended Control	Number
Frozen section containing fat	N/A

Elastic Stain Kit, Verhoeff

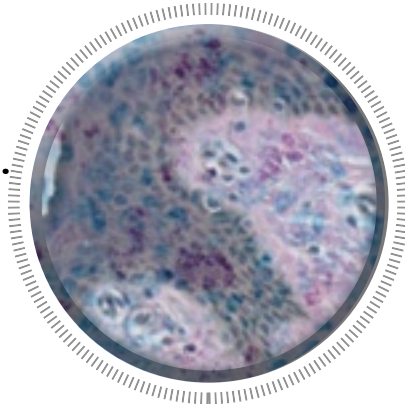

Fite Stain Kit, Leprosy

The **Fite Stain Kit for Leprosy** is another carbol fuchsin based stain for acid fast bacteria but adds peanut oil to counteract staining difficulty normally associated with leprosy bacillus.

Number	Description	UOM	Case Quantity
SS1024-L-125	Fite Stain Kit, Leprosy	125mL	1
SS1024-L-250	Fite Stain Kit, Leprosy	250mL	1
SS1024-L-500	Fite Stain Kit, Leprosy	500mL	1

Components	250mL	500mL
Xylene-Peanut Oil Solution	SSC1136-250	SSC1136-500
Carbol Fuchsin, Ziehl-Neelsen	SSC1055-ZN-250	SSC1055-ZN-500
Acid Water, 1%	SSC1038-250	SSC1038-500
Methylene Blue Working Solution	SSC1096-250	SSC1096-500

Recommended Control	Number
Leprosy positive tissue	N/A

Fite Stain Kit, Nocardia

This kit is similar to the Fite Stain Kit for Leprosy however, Acid Water is used in place of Acid Alcohol in the differentiation step of the **Nocardia** procedure.

Number	Description	UOM	Case Quantity
SS1024-N-125	Fite Stain Kit, Nocardia	125mL	1
SS1024-N-250	Fite Stain Kit, Nocardia	250mL	1
SS1024-N-500	Fite Stain Kit, Nocardia	500mL	1

Components	250mL	500mL
Xylene-Peanut Oil Solution	SSC1136-250	SSC1136-500
Carbol Fuchsin, Ziehl-Neelsen	SSC1055-ZN-250	SSC1055-ZN-500
Acid Alcohol, 1%	SSC1038-250	SSC1038-500
Methylene Blue Working Solution	SSC1096-250	SSC1096-500

Recommended Control	Number
Fite/Nocardia	HCS1011

GMS Fungus Stain Kit

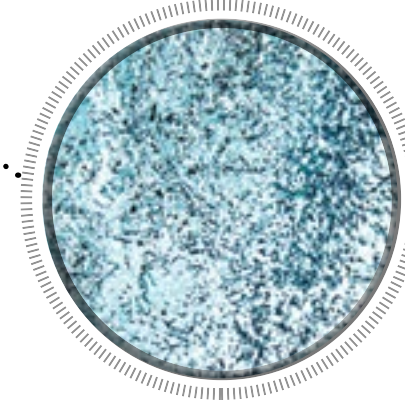

Fontana-Masson Stain Kit (Argentaffin)

The **Fontana-Masson Stain Kit** is used to identify Argentaffin granules and melanin. Argentaffin tissue components are able to take-up silver from silver solutions and reduce it to a visible metallic state, independent of a reducing agent. Argentaffin substances appear black and nuclei pink.

Number	Description	UOM	Case Quantity
SS1020-125	Argentaffin Stain Kit, Fontana-Masson	125mL	1
SS1020-250	Argentaffin Stain Kit, Fontana-Masson	250mL	1
SS1020-500	Argentaffin Stain Kit, Fontana-Masson	500mL	1

Components	250mL	500mL
Silver Nitrate, 10%	SSC1121-250	SSC1121-500
Ammonium Hydroxide, 28%	SSC1045-250	SSC1045-500
Gold Chloride, 0.2%	SSC1080-250	SSC1080-500
Sodium Thiosulfate, 5%	SSC1131-250	SSC1131-500
Nuclear Fast Red	SSC1099-250	SSC1099-500

Recommended Control	Number
Argentaffin	HCS1006

GMS Fungus Stain Kit, Modified

The **GMS (Grocott's Methenamine Silver) Fungus Stain Kit** is a modified silver stain used to distinguish fungi, basement membranes and opportunistic organisms. Fungi and Pneumocystis carinii stain gray to black and mucin appears taupe to dark gray contrasted by a green background counterstained by Light Green.

Number	Description	UOM	Case Quantity
SS1008-125	GMS Fungus Stain Kit, Modified	125mL	1
SS1008-250	GMS Fungus Stain Kit, Modified	250mL	1
SS1008-500	GMS Fungus Stain Kit, Modified	500mL	1

Components	250mL	500mL
Chromic Acid, 5%	SSC1056-250	SSC1056-500
Methenamine-Silver Stock Solution	SSC1095-250	SSC1095-500
Sodium Borate, 5%	SSC1126-250	SSC1126-500
Gold Chloride, 0.1%	SSC1150-250	SSC1150-500
Sodium Thiosulfate, 2%	SSC1130-250	SSC1130-500
Light Green Counterstain	SSC1091-250	SSC1091-500

Recommended Control	Number
Fungus	HCS1000

Gram Stain Kit, Brown & Brenn, Modified

This kit utilizes the **Brown & Brenn Gram stain** method to differentiate gram-positive organisms from gram-negative. Gram-positive organisms stain blue, while gram-negative organisms stain red against a yellow background.

Number	Description	UOM	Case Quantity
SS1004-BB-125	Gram Stain Kit, Brown & Brenn, Modified	125mL	1
SS1004-BB-250	Gram Stain Kit, Brown & Brenn, Modified	250mL	1
SS1004-BB-500	Gram Stain Kit, Brown & Brenn, Modified	500mL	1

Components	250mL	500mL
Crystal Violet-Oxalate Stain	SSC1146-250	SSC1146-500
Iodine Solution, Gram	SSC1089-250	SSC1089-500
Acetone-Alcohol Solution	SSC1163-250	SSC1163-500
Basic Fuchsin, 0.25%	SSC1051-250	SSC1051-500
Picric Acid-Acetone Solution	SSC1255-250	SSC1255-500
Acetone	SSC1192-250	SSC1192-500
Acetone-Xylene Solution	SSC1193-250	SSC1193-500

Recommended Control	Number
Gram	HCS1012

Gram Stain Kit, Brown & Hopps, Modified

This kit utilizes the **Brown & Hopps** method. Gram stains are used to differentiate gram-positive organisms from gram-negative. Gram- positive organisms stain blue, while gram-negative organisms stain red against a yellow background.

Number	Description	UOM	Case Quantity
SS1004-BH-125	GMS Fungus Stain Kit, Modified	125mL	1
SS1004-BH-250	GMS Fungus Stain Kit, Modified	250mL	1
SS1004-BH-500	GMS Fungus Stain Kit, Modified	500mL	1

Components	250mL	500mL
Crystal Violet, 1%	SSC1067-250	SSC1067-500
Iodine Solution, Gram	SSC1089-250	SSC1089-500
Basic Fuchsin, 0.25%	SSC1051-250	SSC1051-500
Gallego Solution	SSC1077-250	SSC1077-500
Picric Acid-Acetone Solution	SSC1255-250	SSC1255-500
Acetone	SSC1192-250	SSC1192-500
Acetone-Xylene Solution	SSC1193-250	SSC1193-500

Recommended Control	Number
Gram	HCS1012

Gram Stain Kit, Brown & Brenn

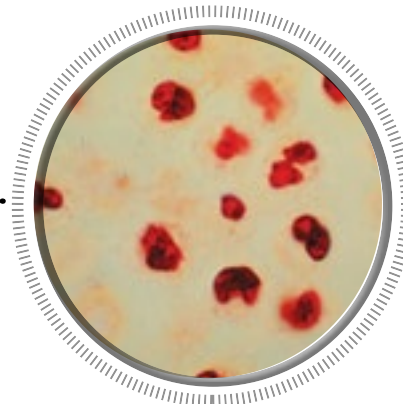

Helicobacter Pylori Stain Kit

This **Helicobacter Pylori Stain Kit** utilizes Alcian Yellow and Toluidine Blue as the primary differentiators. H. Pylori organisms are stained blue while mucin stains yellow. (both are contrasted on a pale blue background.)

Number	Description	UOM	Case Quantity
SS1025-125	Helicobacter Pylori Stain Kit	125mL	1
SS1025-250	Helicobacter Pylori Stain Kit	250mL	1
SS1025-500	Helicobacter Pylori Stain Kit	500mL	1

Components	250mL	500mL
Periodic Acid, 1%	SSC1103-250	FX2108-1
Alcian Yellow Stain	SSC1041-250	SSC1041-500
Sodium Metabisulfite, 5%	SSC1129-250	SSC1129-500
Toluidine Blue Stock Solution	SSC1133-250	SSC1133-500
Sodium Hydroxide, 3%	SSC1128-250	SSC1128-500

Recommended Control	Number
Helicobacter	HCS1013

Iron Stain Kit, Gomori

The **Gomori's Iron Stain Kit** is used for the demonstration of ferric iron in tissues. This kit uses the traditional method and components developed by Gomori. Ferric Iron appears blue and nuclei red. These are present on a pink background counterstained by Nuclear Fast Red.

Number	Description	UOM	Case Quantity
SS1013-125	Iron Stain Kit, Gomori	125mL	1
SS1013-250	Iron Stain Kit, Gomori	250mL	1
SS1013-500	Iron Stain Kit, Gomori	500mL	1

Components	250mL	500mL
Hydrochloric Acid, 20%	SSC1085-250	SSC1085-500
Potassium Ferrocyanide, 10%	SSC1107-250	SSC1107-500
Nuclear Fast Red	SSC1099-250	SSC1099-500

Recommended Control	Number
Iron	HCS1015

Mucicarmine Stain Kit, Classic Southgate

Carmine based Mucicarmine Stain Kits are used for distinguishing mucin- positive epithelial cells from non-mucin producing cells. This kit utilizes the **Southgate** modification. With this method, nuclei stain black, mucin and capsule of Cryptococci stain deep rose to red. These are present on a yellow background counterstained by Metanil Yellow.

Number	Description	UOM	Case Quantity
SS1060-125	Mucicarmine Stain Kit, Classic Southgate	125mL	1
SS1060-250	Mucicarmine Stain Kit, Classic Southgate	250mL	1
SS1060-500	Mucicarmine Stain Kit, Classic Southgate	500mL	1

Components	250mL	500mL
Iron (Pureview™) Hematoxylin, Solution A	SSC1060-250	SSC1060-500
Iron (Pureview™) Hematoxylin, Solution B	SSC1061-250	SSC1061-500
Mucicarmine Stock Solution	SSC1098-250	SSC1098-500
Metanil Yellow Stain	SSC1094-250	SSC1094-500

Recommended Control	Number
Mucin	HCS1017

Periodic Acid Schiff (PAS) Stain Kit

The **Periodic Acid Schiff (PAS) Stain Kit** identifies the presence and pattern of specific carbohydrates in mucin, basement membranes, fungus and glycogen. PAS positive substances stain pink to red, while nuclei appear blue.

Number	Description	UOM	Case Quantity
SS1011-125	Periodic Acid Schiff (PAS) Stain Kit	125mL	1
SS1011-250	Periodic Acid Schiff (PAS) Stain Kit	250mL	1
SS1011-500	Periodic Acid Schiff (PAS) Stain Kit	500mL	1

Components	250mL	500mL
Periodic Acid, 0.5%	SSC1102-250	FX2108
Schiff Reagent	SSC1117-250	FX2109
PureView™ Mayer's Hematoxylin	SSC1059-250	SSC1059-500

Recommended Control	Number
PAS	HCS1018

Reticulum Stain Kit, Gordon & Sweet

The purpose of this Reticulum Stain Kit and others like it, is to demonstrate reticular fibers abundant in liver, spleen and kidney. This kit utilizes the **Gordon & Sweets** method. Reticulum are stained black against a pink to rose background counterstained with Nuclear Fast Red.

Number	Description	UOM	Case Quantity
SS1012-GS-125	Reticulum Stain Kit, Gordon & Sweet	125mL	1
SS1012-GS-250	Reticulum Stain Kit, Gordon & Sweet	250mL	1
SS1012-GS-500	Reticulum Stain Kit, Gordon & Sweet	500mL	1

Components	250mL	500mL
Potassium Permanganate, 1%	SSC1113-250	SSC1113-500
Oxalic Acid, 1%	SSC1101-250	SSC1101-500
Ferric Ammonium Sulfate, 2.5%	SSC1072-2.5-250	SSC1072-2.5-500
Silver Nitrate, 10%	SSC1121-250	SSC1121-500
Ammonium Hydroxide, 28%	SSC1045-250	SSC1045-500
Formalin Solution, 10%	SSC1074-250	SSC1074-500
Gold Chloride, 0.2%	SSC1080-250	SSC1080-500
Sodium Thiosulfate, 5%	SSC1131-250	SSC1131-500
Nuclear Fast Red	SSC1099-250	SSC1099-500
Sodium Hydroxide, 3%	SSC1128-250	SSC1128-500

Recommended Control	Number
Reticulum	HCS1022

CDI's Special Stain Kits may be purchased as a complete kit or as individual components ordered in 250mL and 500mL sizes.

Other formulations available, please inquire.

Steiner Stain Kit, Modified Chapman (Uranyl Nitrate Free)

Utilizing a 10% Zinc Formalin sensitizer as suggested by Chapman, this **Modified Steiner Stain Kit** identifies spirochetes and non-filamentous bacteria in paraffin embedded tissues. Spirochetes and other non- filamentous bacteria stain dark brown to black while background tissue appear bright yellow to light brown.

Number	Description	UOM	Case Quantity
SS1014-MC-125	Steiner Stain Kit, Modified Chapman	125mL	1
SS1014-MC-250	Steiner Stain Kit, Modified Chapman	250mL	1
SS1014-MC-500	Steiner Stain Kit, Modified Chapman	500mL	1

Components	250mL	500mL
Steiner Sensitizer Solution	SSC1137-250	SSC1137-500
Silver Nitrate, 1%	SSC1120-250	SSC1120-500
Gum Mastic Alcoholic, 2.5%	SSC1083-250	SSC1083-500
Hydroquinone Powder, 0.5g	SSC1088-5G	SSC1088-5G

Recommended Control	Number
Spirochete	HCS1023

Steiner-Steiner Stain Kit

Utilizing Uranyl Nitrate as a sensitizer, the **Steiner & Steiner Stain Kit** identifies spirochetes and non-filamentous bacteria in paraffin embedded tissues. Spirochetes and other non-filamentous bacteria stain dark brown to black while background tissue appear bright yellow to light brown.

Number	Description	UOM	Case Quantity
SS1014-125	Steiner-Steiner Stain Kit	125mL	1
SS1014-250	Steiner-Steiner Stain Kit	250mL	1
SS1014-500	Steiner-Steiner Stain Kit	500mL	1

Components	250mL	500mL
Uranyl Nitrate, 1%	SSC1134-250	SSC1134-500
Silver Nitrate, 1%	SSC1120-250	SSC1120-500
Gum Mastic Alcoholic, 2.5%	SSC1083-250	SSC1083-500
Hydroquinone Powder, 0.5g	SSC1088-5G	SSC1088-5G

Recommended Control	Number
Spirochete	HCS1023

Steiner-Steiner Stain Kit

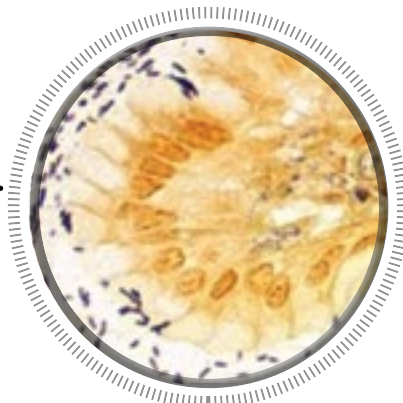

Trichrome Stain Kit, Gomori's One Step, Aniline Blue

Trichrome Stains are primarily used to differentiate between collagen and smooth muscle in paraffin embedded tissues. This kit utilizes the **Gomori's One Step** method. This refers to the multiple stain reaction which has been consolidated into a single step using the **Gomori's Trichrome Stain Solution**, as compared to a multi step method such as Masson's. The connective tissue fiber dye used in this particular formulation is **Aniline Blue**. This kit produces black nuclei with red cytoplasm and muscle fibers; collagen and mucin appear blue.

Number	Description	UOM	Case Quantity
SS1026-GAB -125	Trichrome Stain Kit, Gomori's One Step, Aniline Blue	125mL	1
SS1026-GAB -250	Trichrome Stain Kit, Gomori's One Step, Aniline Blue	250mL	1
SS1026-GAB -500	Trichrome Stain Kit, Gomori's One Step, Aniline Blue	500mL	1

Components	250mL	500mL
Bouin's Solution	SSC1053-250	SSC1053-500
Iron (Pureview™) Hematoxylin, Solution A	SSC1060-250	SSC1060-500
Iron (Pureview™) Hematoxylin, Solution B	SSC1061-250	SSC1061-500
Gomori's One Step Trichrome Stain, Aniline Blue	SSC1081-250	SSC1081-500
Acetic Acid, 0.5%	SSC1030-250	SSC1030-500

Recommended Control	Number
Trichome	HCS1024

Trichrome Stain Kit, Gomori's One Step, Light Green

Trichrome Stains are primarily used to differentiate between collagen and smooth muscle in paraffin embedded tissues. This kit utilizes the **Gomori's One Step** method; referring to the consolidation into a single step using the **Gomori's Trichrome Stain Solution**, from the multiple stain process such as Masson's. **Light Green SF** is the connective tissue (fiber) dye used in this particular formulation. This kit produces black nuclei with red cytoplasm and muscle fibers; collagen and mucin appear green.

Number	Description	UOM	Case Quantity
SS1026-GLG -125	Trichrome Stain Kit Gomori's One Step, Light Green	125mL	1
SS1026-GLG -250	Trichrome Stain Kit Gomori's One Step, Light Green	250mL	1
SS1026-GLG -500	Trichrome Stain Kit Gomori's One Step, Light Green	500mL	1

Components	250mL	500mL
Bouin's Solution	SSC1053-250	SSC1053-500
Iron (Pureview™) Hematoxylin, Solution A	SSC1060-250	SSC1060-500
Iron (Pureview™) Hematoxylin, Solution B	SSC1061-250	SSC1061-500
Gomori's One Step Trichrome Stain, Light Green	SSC1082-250	SSC1082-500
Acetic Acid, 0.5%	SSC1030-250	SSC1030-500

Recommended Control	Number
Trichome	HCS1024

CDI's Special Stain Kits may be purchased as a complete kit or as individual components ordered in 250mL and 500mL sizes.

Other formulations available, please inquire.

Trichrome Stain Kit, Masson, Aniline Blue

Trichrome Stains are primarily used to differentiate between collagen and smooth muscle in paraffin embedded tissues. This **Masson's** method produces black nuclei with red cytoplasm and muscle fibers; collagen and mucin appear blue.

Number	Description	UOM	Case Quantity
SS1026-MAB-125	Trichrome Stain Kit, Masson, Aniline Blue	125mL	1
SS1026-MAB-250	Trichrome Stain Kit, Masson, Aniline Blue	250mL	1
SS1026-MAB-500	Trichrome Stain Kit, Masson, Aniline Blue	500mL	1

Components	250mL	500mL
Bouin's Solution	SSC1053-250	SSC1053-500
Iron (Pureview™) Hematoxylin, Solution A	SSC1060-250	SSC1060-500
Iron (Pureview™) Hematoxylin, Solution B	SSC1061-250	SSC1061-500
Biebrich Scarlet-Acid Fuchsin Solution	SSC1052-250	SSC1052-500
Phosphomolybdic/Phosphotungstic Acid	SSC1104-250	SSC1104-500
Aniline Blue Stain	SSC1048-250	SSC1048-500
Acetic Acid, 1%	SSC1031-250	SSC1031-500

Recommended Control	Number
Trichome	HCS1024

Von Kossa (Modified) Calcium Stain Kit

The **Von Kossa Stain** highlights the presence of calcium in tissue. Light (specifically ultra-violet wavelengths) is used to develop the stain which produces brown to black calcium salts contrasted by a pink to red background.

Number	Description	UOM	Case Quantity
SS1027-125	Von Kossa (Modified) Calcium Stain Kit	125mL	1
SS1027-250	Von Kossa (Modified) Calcium Stain Kit	250mL	1
SS1027-500	Von Kossa (Modified) Calcium Stain Kit	500mL	1

Components	250mL	500mL
Silver Nitrate, 5%	SSC1122-250	SSC1122-500
Sodium Thiosulfate, 5%	SSC1131-250	SSC1131-500
Nuclear Fast Red	SSC1099-250	SSC1099-500

Recommended Control	Number
Calcium containing tissue	N/A

Warthin-Starry Stain Kit

The **Warthin-Starry Stain Kit** demonstrates Spirochetes, H. Pylori, Cat Scratch Fever bacteria, and Legionnaires' Disease in paraffin embedded tissues. Spirochetes and other bacteria appear black against a pale yellow to brown background.

Number	Description	UOM	Case Quantity
SS1028-125	Warthin-Starry Stain Kit	125mL	1
SS1028-250	Warthin-Starry Stain Kit	250mL	1
SS1028-500	Warthin-Starry Stain Kit	500mL	1

Components	250mL	500mL
Acidulated Water, pH 4.0	SSC1210-250	SSC1210-500
Silver Nitrate Solution (Acidulated), 2%	SSC1119-250	SSC1119-500
Gelatin Solution (Acidulated), 5%	SSC1273-250	SSC1273-500
Hydroquinone Solution (Acidulated)	SSC1087-250	SSC1087-500

Recommended Control	Number
Spirochete	HCS1023

Histology Control Slides

CDI's control slides consist of formalin-fixed, paraffin-embedded tissue sections, which contain known distinctive tissue elements. One slide in each box features a serial section that has been stained using the specified staining procedure that is included in each box.

Available in a box of 20 unless otherwise indicated. Add "-C" after item number for "bulk" quantity CS/100

Item #	Type of control slide	Item #	Type of control slide
HCS1002	Acid Fast Bacteria Control	HCS1014	Hepatitis Control
HCS1004	Alcian Blue Control	HCS1015	Iron Control
HCS1005	Amyloid Control	HCS1003	Mast Cell Control (25/bx)
HCS1006	Argentaffin Control	HCS1016	Melanin Control
HCS1007	Argyrophil Control	HCS1017	Mucin Control
HCS1008	Bile Control	HCS1019	PAS (With Digestion) Control
HCS1001	Calcium, Von Kossa Stain Control (25/bx)	HCS1018	Periodic Acid Schiff Control
HCS1009	Copper Control	HCS1020	Pneumocystis Control
HCS1010	Elastic Control	HCS1021	PTAH Control
HCS1011	Fite/Nocardia Control	HCS1022	Reticulum (Retic) Control
HCS1000	Fungus Control	HCS1023	Spirochete Control
HCS1012	Gram Control	HCS1024	Trichrome Control
HCS1013	Helicobacter Control		





LABELS
MARKERS
PENCILS

DESIGNED FOR ACCURATE AND
RELIABLE SPECIMEN IDENTIFICATION

Custom, Stock, & Blank Labels • Markers
• Pencils • Printer Ribbons





LEADING LAB MARKER SINCE 1999

Marker Pens and Pencils



Moist Mark Plus™

Resistant to all solvents. Writes smooth, dark and fine on all cassettes and all slides. Use for cytology as a "dotting" reference marker as well. Strictest manufacturing standards. Proprietary, formulated ink.

Item	Qty
MP1000	BX/10
MP2100	CS/100



Pencils

Pencils/ Slide and Cassette Marking Pack with 12 pencils. Writes dark and smooth. Formulated for lab use.

Item	Qty
N1000	PK/12

Slide Labels

Slide Labels (Zebra Compatible)

Xylene Resistant Slide Labels

.875" x .875" (22 x 22mm), 1 across

Perforated, gloss finish, opaque liner.

Item	Size/Desc.	Qty
XRI40-1A1CP	1" Core	Roll/1,800
XRI40-1A3CP	3" Core	Roll/1,800

.875" x .875" (22 x 22mm), 4 across

Perforated, gloss finish, opaque liner. 3" core available in gloss and matte finish.

Item	Size/Desc.	Qty
XRI40-4A1CP	1" Core (Gloss finish)	Roll/7,200
XRI40-4A3CP	3" Core (Gloss finish)	Roll/7,200
XRMI40-4A3CP	3" Core (Matte finish)	Roll/7,200

Xylene Resistant Slide Labels

.9375" x .9375" (23.8 x 23.8mm), 1 across

Perforated, gloss and matte finish, opaque liner.

Item	Size/Desc.	Qty
XRI71-1A1CP	1" Core (Gloss finish)	Roll/1,800
CDI-M171	1" Core (Matte finish)	Roll/2,500

Slide Labels (Cognitive Compatible)

Xylene Resistant Slide Labels

.875" x .875" (22 x 22mm), 1 across

Perforated, transparent liner, labels rolled to inside.

Item	Size/Desc.	Qty
TFC140-1A1CPi	1" Core	Roll/1,800

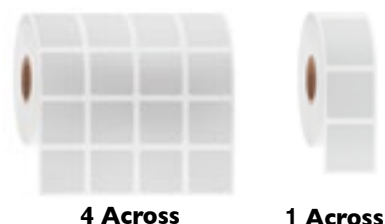

Xylene Resistant Slide Labels

.9062" x .875", (23 x 22.2mm), 1 across

Perforated, matte finish, opaque liner.

Item	Size/Desc.	Qty
XRMI43-1A1CP	1" Core	Roll/2,500

Xylene Resistant IHC Slide Labels

.9375" x .875" (23.8 x 22mm), 1 across

Perforated, gloss finish, opaque liner.

Ventana Compatible.

Item	Size/Desc.	Qty
LBL1700-VEN	1" Core	Roll/1,700

Xylene Resistant Slide Labels

.8661" x .5906", (22 x 15mm), 1 across

Perforated, transparent liner.

Leica Compatible.

Item	Size/Desc.	Qty
TFC352MDA-1A1CP	1" Core	Roll/3,000



Popular labels shown. Contact us for any size label.

Printer Ribbons

Xylene Resistant Resin Ribbons (Zebra Compatible)



1/2" Core

1" Core

For Desktop Printers

For Table Top Industrial Printers



LBL-RIB-XR



CDI-B324



B324040BOS



B324040EOS



B324110BOS

Item	Size/Desc.	Inches x Feet	Metric	Qty	Item	Size/Desc.	Inches x Feet	Metric	Qty
LBL-RIB-XR	1/2" Core	2.5" x 242'	63mm X 74m	1 Roll	B324040BOS	1" Core	1.5" x 984'	38mm x 300m	1 Roll
CDI-B324	1/2" Core	4.33" x 242'	110mm X 74m	1 Roll	B324040EOS	1" Core	1.5" x 1476'	38mm x 450m	1 Roll
					B324110BOS	1" Core	4.33" x 984'	110mm x 300m	1 Roll

Xylene Resistant Resin Ribbons (Cognitive Compatible)

Item	Size/Desc.	Inches x Feet	Metric	Qty
0004-00-0044-02	1/2" Core	2.4" x 460'	60mm x 140m	1 Roll
18105564	1/2" Core (multiple slats)	2.2" x 242'	56mm x 74m	1 Roll

Pinfed Labels

Color Laboratory Labeling Tape

A wide assortment of vinyl-coated, soft satin-finish paper tape that sticks to virtually any surface. It can be written on with pencil, fiber-tip or ball point pen, and lab markers. Available per roll.



Item	Description	Color
PAT-13WH	Color lab tape 0.5" x 180' / 13mm x 55m	White
PAT-13YE	Color lab tape 0.5" x 180' / 13mm x 55m	Yellow
PAT-13LBL	Color lab tape 0.5" x 180' / 13mm x 55m	Light blue
PAT-13RE	Color lab tape 0.5" x 180' / 13mm x 55m	Red
PAT-13GA	Color lab tape 0.5" x 180' / 13mm x 55m	Green apple
PAT-13PI	Color lab tape 0.5" x 180' / 13mm x 55m	Pink
PAT-13GR	Color lab tape 0.5" x 180' / 13mm x 55m	Gray
PAT-13OR	Color lab tape 0.5" x 180' / 13mm x 55m	Orange
PAT-13PU	Color lab tape 0.5" x 180' / 13mm x 55m	Purple
PAT-13GS	Color lab tape 0.5" x 180' / 13mm x 55m	Green Seafoam
PAT-18WH	Color lab tape 0.71" x 180' / 18mm x 55m	White
PAT-18YE	Color lab tape 0.71" x 180' / 18mm x 55m	Yellow
PAT-18LBL	Color lab tape 0.71" x 180' / 18mm x 55m	Light Blue
PAT-18RE	Color lab tape 0.71" x 180' / 18mm x 55m	Red
PAT-18GA	Color lab tape 0.71" x 180' / 18mm x 55m	Green Apple
PAT-18PI	Color lab tape 0.71" x 180' / 18mm x 55m	Pink
PAT-18GR	Color lab tape 0.71" x 180' / 18mm x 55m	Gray
PAT-18OR	Color lab tape 0.71" x 180' / 18mm x 55m	Orange
PAT-18PU	Color lab tape 0.71" x 180' / 18mm x 55m	Purple
PAT-18GS	Color lab tape 0.71" x 180' / 18mm x 55m	Green Seafoam
PAT-24WH	Color lab tape 0.94" x 180' / 24mm x 55m	White
PAT-24YE	Color lab tape 0.94" x 180' / 24mm x 55m	Yellow
PAT-24LBL	Color lab tape 0.94" x 180' / 24mm x 55m	Light Blue
PAT-24RE	Color lab tape 0.94" x 180' / 24mm x 55m	Red
PAT-24GA	Color lab tape 0.94" x 180' / 24mm x 55m	Green Apple
PAT-24PI	Color lab tape 0.94" x 180' / 24mm x 55m	Pink
PAT-24GR	Color lab tape 0.94" x 180' / 24mm x 55m	Gray
PAT-24OR	Color lab tape 0.94" x 180' / 24mm x 55m	Orange
PAT-24PU	Color lab tape 0.94" x 180' / 24mm x 55m	Purple
PAT-24GS	Color lab tape 0.94" x 180' / 24mm x 55m	Green Seafoam



Pinfed labels

4, 5 or 6 across. Pinfed labels: Size: 15/16" X 15/16"
Material: EDP
Adhesive: Permanent
Minimum Order 10,000 Labels (stack approx few inches fan fold)

Item	Description	Qty
LBL1010-4	Pinfed	4 across
LBL1010-5	Pinfed	5 across
LBL1010-6	Pinfed	6 across

Laser Printer Labels

Laser Printer labels 15/16" x 15/16". Sheet-fed labels for easy printing.

Item	Description	Qty
LBL1008	Laser	PK/1056 (88 per sheet/12 sheets)
LBL1008B	Laser	CS/8800 (88 per sheet/100 sheets)

Custom Labels

Custom Print Labels, Peel and Stick

Sheet labels. 15/16" x 15/16".

White with custom print or Color with custom print.

Item	Description	Qty
LBL1006	Thin Style	PK/10,000
LBL1007	Thin Style	PK/1,000



Please specify color and size when ordering

1 White	2 Yellow	3 Green	4 Red	5 Orange	6 Blue	7 Pink	8 Tan	9 Salmon	10 Copper	11 Rose	12 Violet	13 Lavender
14 Gray	15 Lime	16 Aqua	17 Chartreuse	18 Gold	19 Silver	20 Magenta	21 Dk. Red	22 Maroon	23 DK. Brown	24 Dk. Blue	25 Dk. Green	26 Black

Consecutive Numbered Slide Labels

Xylene Resistant Cytology Slide Labels

Roll form Pre-numbered Xylene Resistant Cytology Slide Labels.

1,000/Roll. (Minimum order 10,000).

Available Clear or Opaque (white). Choice of color ink.

White (opaque) or clear label.
Choose ink color



Item	Description
LBL1011	Opaque (white)-Roll
LBL1012	Clear-Roll



Clear: Standard Size: 5/8" x 7/8"

White (opaque): Standard Size: 5/8" x 7/8"

White with Bar-Code:

Standard Size: 3/4" x 7/8", 7/8" x 7/8", 5/8" x 7/8"



For customized labels
download our
custom template
on our website
www.cancerdiagnostics.com

Please specify ink color and size when ordering

1 White	2 Yellow	3 Green	4 Red	5 Orange	6 Blue	7 Pink	8 Tan	9 Salmon	10 Copper	11 Rose	12 Violet	13 Lavender
14 Gray	15 Lime	16 Aqua	17 Chartreuse	18 Gold	19 Silver	20 Magenta	21 Dk. Red	22 Maroon	23 DK. Brown	24 Dk. Blue	25 Dk. Green	26 Black

Pre-Numbered Labels

Paper, Pads or Roll Slide Labels

Histology Pre-Numbered Paper Labels pre-printed with consecutive numbers and prefix of choice. Choose any color label. Printed on pads unless rolls are specified.

Item	Description	Qty
LBL1013	15/16" x 15/16"	1,000/Pads
LBL1014	7/8" x 7/8"	1,000/Pads

Black ink. Choose paper
label color



Xylene Resistant Labels, Roll

(1,000) min order: 10,000 labels.

Roll form consecutive numbers are printed on the highest quality pressure sensitive material with the optimal adhesive stock that holds tight at temperatures from -50 - 160F. Default size 1/2" x 1 1/4" round-corner labels. White label with choice of ink color. Colored backgrounds available for slight upcharge. A standard 1" core is used with 3" available upon request.

* For ink colors see opposite page.

Item	Description
LBR600	(Roll Form)

Standard Sizes:

- 1/2" x 1 1/4"
- 1/2" x 1 1/2"
- 1/4" x 1"

OP-3001 4002	OP-3001 4003
OP-3001 4002	OP-3001 4003
OP-3001 4002	OP-3001 4003

Thin Prep Labels & Pre-Printed

Per 1,000. Min. order 5,000

Please specify type of barcode, number of labels per set, numbering sequence, and which type of instrument label is being used with, or simply provide sample of current label.

Item	Description
LA-BIF-209-TPL	Roll Form



For customized labels download our
custom template on our website
www.cancerdiagnostics.com



IHC

IMMUNOHISTOCHEMISTRY

Antibodies • Detection Kits

Tissue Micro Array and Control Slides • Ancillaries

Manufactured and developed in accordance with FDA QSR 21 CFR Part 820 cGMP and ISO 13485:2003 standards.

Antibodies



Ordering Info: Mouse and Rabbit Antibodies

Predilute/Ready-to-use

- 3 mL Predilute (30 tests)
- 7 mL Predilute (70 tests)
- 15 mL Predilute (150 tests)

- No need for optimization
- Compatible with biotin or polymer based detection systems
- Predilute/Ready-to-use: diluted in proprietary protein blocker/stabilizer

Concentrated

- .1 mL Concentrate
- .5 mL Concentrate
- 1 mL Concentrate

- Cost effective solution
- Compatible with biotin or polymer based detection systems
- Can be optimized to meet the needs of each laboratory
- Concentrated antibodies diluted in proprietary protein blocker/stabilizer

Specify antibody item number or name, clone, and packaging size to order.

Rabbit Monoclonal Antibodies

Why Rabbit Monoclonal Antibodies?

- Higher Affinity
- Stronger Signal
- Less Background
- Multiple Applications (IHC , Flow Cytometry, etc.)
- Increased Sensitivity
- Higher Specificity
- Supported by research publications
- Large portfolio of over 130 Rabbit Monoclonal Antibodies

Mouse and Rabbit Monoclonal Comparison

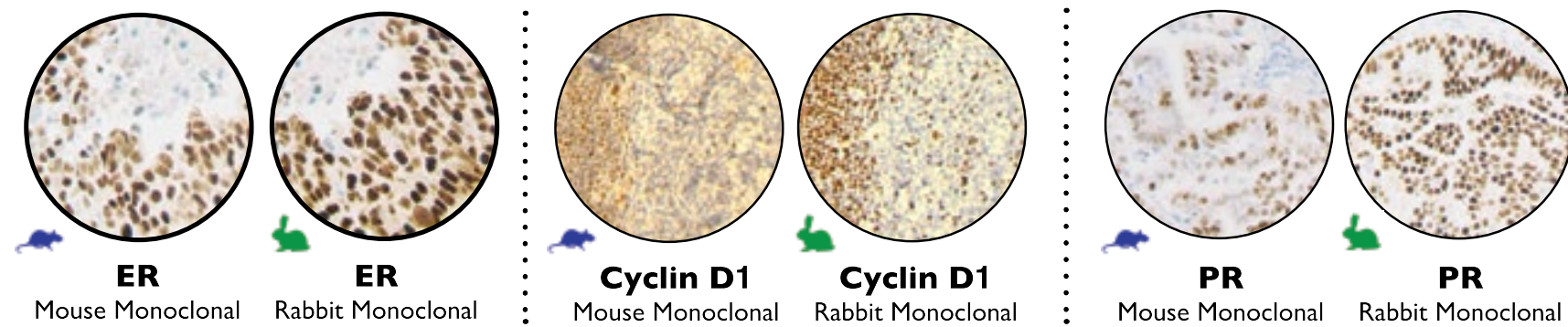

Both antibodies in each comparison were evaluated using the same epitope retrieval, detection kit, IHC protocols and methodologies. All results produced using CDI Ancillaries and ImmunoDetector HRP/DAB Kit (BSB0001).

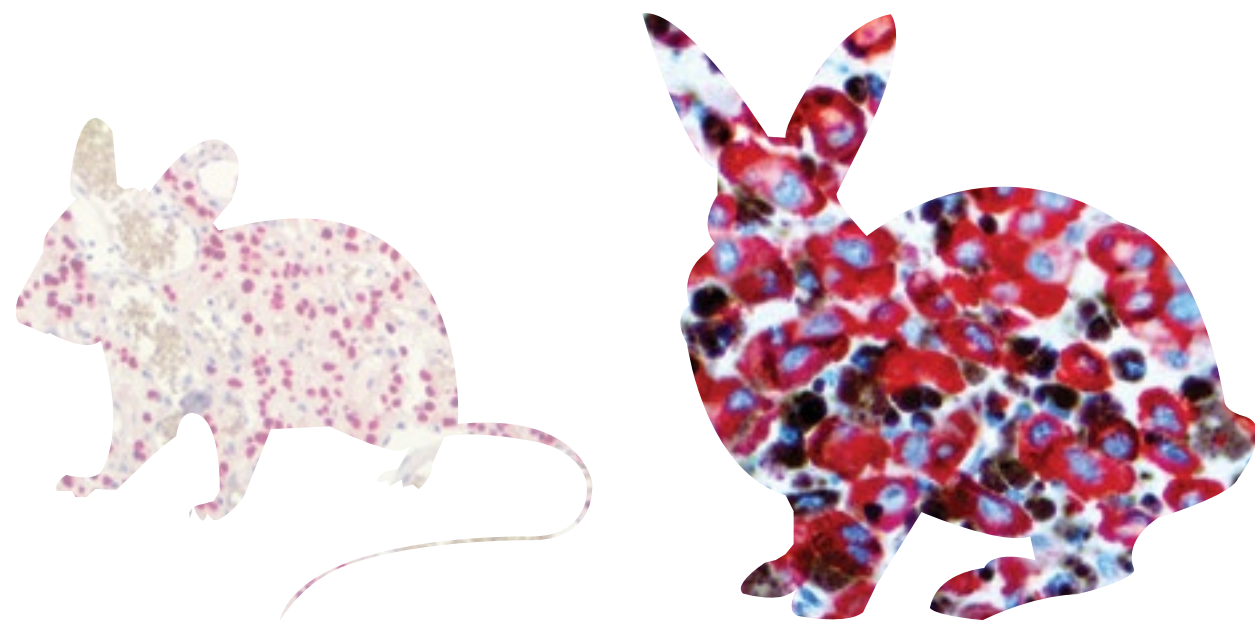

Antibodies (alphabetical)

ANTIBODY	ANTIBODY TYPE	CLONE
Alpha-1-Antichymotrypsin	RPab	N/A
Alpha-1-Antitrypsin	RPab	N/A
ACTH	MMab	BSB-25
Actin, Muscle Specific	MMab	HHF35
Actin, Smooth Muscle	MMab	BSB-15
Adenovirus	MMab	20/11 & 2/6
Adipophilin/ADRP	MMab	BSB91
ALDH1A1	RMab	EP168
ALK-1	RMab	EP302
ALK-1	RMab	RBT-ALK1
Alpha-Fetaprotein	MMab	BSB-23
Alpha-Fetaprotein	RMab	EP209
* Alpha Synuclein	MMab	BSB-114
AMACRacemase/P504S	RMab	13H4
Amyloid A	RMab	EP335
* Amyloid Beta	RMab	RBT-A4
Androgen Receptor	MMab	BSB-4 (AR-D12)
Annexin A1	MMab	BSB-95
Arginase-1	RMab	EP261
* ATRX	MMab	BSB-108
B7H3/CD276	RMab	RBT-B7H3
* BAP1	MMab	BSB-109
Bax	RMab	E63
BCA-225	MMab	Cu-118
bcl-2	MMab	BSB-5
bcl-2	RMab	EP36
* bcl-6	MMab	BSB-26
bcl-6	RMab	EP278
bcl-6	RMab	RBT-bc16
bcl-10	MMab	BSB-22
Bclx	RMab	EP94
Beta-Catenin	MMab	14
Beta-Catenin	RMab	EP35
BG8 Lewis Y	MMab	F3
BOB.1	RMab	EP114
* Brachyury	RPab	Polyclonal
BRAF V600E	RMab	RM8
c-MET/HGFR	RMab	EP1454Y
c-Myc	MMab	9E10
c-Myc	RMab	EP121
c-Myc	RPab	N/A
CA-125	MMab	OC-125
CA-125	RMab	EP48
C3d	RPab	Polyclonal
C4d	RPab	Polyclonal
C4d	RMab	EP273
Cadherin-6	RMab	EP217
Cadherin 17/Li-Cadherin	RMab	EP86
Calcitonin	RPab	N/A
Calcitonin	RMab	EP92
Caldesmon	MMab	BSB-19
Calponin	MMab	BSB-20
Calretinin	RMab	EP1798
Carbonic Anhydrase 9	RMab	EP161
* Caveolin 1	RMab	EP353

ANTIBODY	ANTIBODY TYPE	CLONE
CA15-3	RMab	DF3
CA 19-9	MMab	121SLE
CD1a	RMab	EP80
CD2	MMab	AB75
CD3 Epsilon	RMab	RBT-CD3e
CD3	RMab	RBT-CD3
CD4	RMab	RBT-CD4
CD5	RMab	RBT-CD5
CD5	RMab	RED1
CD6	MMab	BSB-54
CD7	MMab	LP15
CD7	RMab	EP132
CD8	MMab	C8/144B
CD8	RMab	EP334
CD10	MMab	56C6
CD10	RMab	EP195
CD11b	RMab	EP45
CD11c	RMab	EP157
CD13	MMab	38C12
CD13	RMab	EP117
CD14	MMab	7
CD14	RMab	EP128
CD15	MMab	MMA
CD15	RMab	EP272
* CD16	RMab	EP364
CD19	MMab	BSB-97
CD19	RMab	EP169
CD20	MMab	L26
CD21	RMab	EP64
CD23	MMab	1B12
CD23	RMab	EP75
CD25	MMab	4C9
CD25	RMab	RBT-CD25
CD30	MMab	Ber-H2
CD31	MMab	1A10
* CD33	RMab	RBT-CD33
CD34	MMab	QBEnd/10
CD34	RMab	EP88
CD35	MMab	RLB25
CD35	RMab	EP197
CD38	MMab	SPC32
CD38	RMab	EP135
CD41/Integrin alpha 11b	RMab	EP178
CD43	MMab	MT1
CD44	MMab	BSB-12
CD45	MMab	2B11 & PD7/26
CD45R	MMab	MB1
CD45RA	MMab	4KB5
CD45RO	MMab	UCHL-1
CD56	MMab	123C3.D5
CD57	MMab	BSB-10
CD61	MMab	2f2
CD63	MMab	NK1/C3
CD68	MMab	BSB-8
CD68	MMab	KP-1

ANTIBODY	ANTIBODY TYPE	CLONE
CD71	MMab	10F11
CD74	MMab	LN2
CD75	MMab	LN1
CD79a	MMab	JCB117
CD99	MMab	BSB-9
CD103/ITGAE	RMab	EP206
CD105/Endoglin	RPab	Polyclonal
CD105	RMab	EP274
CD117	RMab	EP10
CD123, IL-3RA	MMab	BSB-59
CD138	MMab	B-A38
CD138	RMab	EP201
CD163	MMab	10D6
CD163	RMab	EP324
CDK2	RMab	RBT-CDK2
CDK4	RMab	EP180
CDX2	RMab	EP25
CEA	MMab	BSB-13
CEA	RPab	Polyclonal
Chromagrain A	MMab	LK2H10
Claudin-1	RPab	Polyclonal
Claudin-5	RMab	EP224
Clusterin/Apolipoprotein J	RMab	EP181
Collagen Type IV	MMab	CIV22
COX-2	RMab	EP293
COX-2	RMab	RBT-COX2
■ CTLA-4/CD152	MMab	BSB-88
Cyclin B1	RMab	RBT-B1
Cyclin D1	RMab	EP12
Cyclin D1	RMab	RBT14
Cyclin E1	RMab	EP126
Cytokeratin 4	RMab	EP4
Cytokeratin 5	RMab	EP24
Cytokeratin 5 & 6	RMab	DS/16B4
Cytokeratin 5 & 6	RMab	EP24 & EP67
Cytokeratin 5 & 14	RMab	EP24 & EP61
Cytokeratin 5 & ERG	RMab	EP24/EP111
Cytokeratin 5 & 6 & ERG	RMab	EP24/EP67/
EP111		
Cytokeratin 5 & 14	RMab	EP24/EP61
Cytokeratin 6	RMab	EP67
Cytokeratin 6 & CDKX2	RMab	EP16 & EP25
Cytokeratin 7	MMab	OV-TL 12/30
Cytokeratin 7	RMab	EP16
Cytokeratin 7 & CDX2	RMab	EP16 & EP25
Cytokeratin 8	RMab	EP17
Cytokeratin 8 & 18	MMab	B22.1/B23.1
Cytokeratin 8 & 18	RMab	EP17/EP30
Cytokeratin 10	RMab	EP97
Cytokeratin 14	RMab	EP61
Cytokeratin 14	MMab	LL002
Cytokeratin 15	RMab	EP14
Cytokeratin 16	RMab	EP297
Cytokeratin 17	MMab	BSB-33
Cytokeratin 17	RMab	EP98
Cytokeratin 18	RMab	EP30
Cytokeratin 19	MMab	BSB-34
Cytokeratin 19	RMab	EP72
Cytokeratin 20	MMab	Ks20.8
Cytokeratin 20	RMab	EP23

QUICK GUIDE REFERENCE
 * NEW ANTIBODIES ■ ASR ■ RUO

PLEASE NOTE: All antibodies are IVD unless otherwise specified.

All Antibodies Available
Concentrate and Predilute

ANTIBODY	ANTIBODY TYPE	CLONE
Cytokeratin 35BH11	MMab	35betaH11
Cytokeratin Cocktail AE1&AE3	MMab	AE1/AE3
Cytokeratin HMW 34BE12	MMab	34betaE12
Cytokeratin HMW/AE3	MMab	AE3
Cytokeratin LMW CAM5.2	MMab	CAM5.2
Cytokeratin LMW/AE1	MMab	AE1
Cytokeratin OSCAR	MMab	OSCAR
■ Cytomegalovirus	MMab	8B1.2, 1G5.2 & 2D4.2
Desmin	MMab	D33
Desmin	RMab	EP15
Desmoglein-3	MMab	BSB-61
Desmoglein-3	RMab	EP306
DOG1	RMab	EP332
DOG1	RMab	RBT-DOG1
E-Cadherin	RMab	EP6
E2F4	RMab	EP252
■ EGFR	MMab	31G7
■ EGFR Phospho	RMab	EP11
EMA	MMab	E29
EpCAM/Epithelial Specific Antigen	MMab	BerEP4
EpCAM/Epithelial Specific Antigen	MMab	MOC-31
■ Epstein Barr Virus, LMP-1	MMab	CS1-4
ERCC1	RMab	EP219
ERG	RMab	EP1111
■ Estrogen Receptor	MMab	BSB-1
■ Estrogen Receptor	RMab	EP1
■ Estrogen Receptor	RMab	RBT11
Factor VIII-Related Antigen	RPab	N/A
Factor XIIIa	RMab	EP292
Fascin	MMab	BSB-36
Fli-1	MMab	G146-222
Follicular Dendritic Cell	MMab	CAN.42
FOXA1/HNF-3A	RPab	Polyclonal
FOXA1/HNF-3A	RMab	EP277
FOXP01	RMab	EP290
FOXP1	RMab	EP137
FOXP3	RPab	Polyclonal
FOXP3	RMab	EP340
FSH	MMab	BSB-55
Galectin-3	MMab	9C4
Gastrin	RPab	N/A
* GATA 3	MMab	L50-823
GATA 3	RMab	EP368
GCDFP-15	MMab	23A3
GCDFP-15	RMab	EP95
GFAP	MMab	G-A-5
GFAP	RMab	EP13
* GH	MMab	BSB-99
GH	RPab	N/A
GH	RMab	E267
* Glucagon	MMab	BSB-111
Glucagon	RPab	Polyclonal
Glucagon	RMab	EP74
GLUT1	RMab	EP141
Glutamine Synthase	MMab	GS-6
Glycophorin-A	MMab	GA-R2
Glypican-3	MMab	1G12
Granzyme B	RPab	Polyclonal
Granzyme B	RMab	EP230
hCG	MMab	BSB-38

QUICK GUIDE REFERENCE
 * NEW ANTIBODIES ■ ASR ■ RUO

PLEASE NOTE: All antibodies are IVD unless otherwise specified.

All Antibodies Available
Concentrate and Predilute

ANTIBODY	ANTIBODY TYPE	CLONE
* HE4	RMab	EP370
■ Helicobacter pylori	MMab	BSB-37
■ Helicobacter pylori	RPab	Polyclonal
■ Helicobacter pylori	RMab	EP279
Hemaglobin A	RMab	EP124
■ Hepatitis B Virus Core	RPab	Polyclonal
■ Hepatitis B Virus Surface Antigen	MMab	T9
Hepatocyte Specific Antigen/ Hep Par 1	MMab	OCH1E5
■ HER-2 neu	MMab	BSB-3
■ HER-2 neu	RMab	EP3
■ HER-2 neu	RMab	RBT-HER2
■ HER-2 neu Phospho	RMab	EP123
HER-3/c-erbB-3	RMab	RBT-HER3
■ Herpes Simplex Virus I	RPab	Polyclonal
■ Herpes Simplex Virus I	MMab	10A3
■ Herpes Simplex Virus II	RPab	Polyclonal
■ Herpes Simplex Virus II	MMab	BSB-116
■ Herpes Simplex Virus I & II	RPab	Polyclonal
■ Herpes Simplex Virus I & II	MMab	10A3 / BSB-116
hGAL.GCET2	RMab	EP316
■ HHV-8	MMab	13B10
HIF-1a	RMab	EP118
Histone H3 Phospho	RPab	Polyclonal
Histone H3 Phospho	RMab	EP233
HLA-DR alpha chain	RMab	EP96
HLA-DRβ1 beta chain	RMab	EP191
hPL	RMab	EP241
hPL	RPab	Polyclonal
■ HPV	MMab	BSB-66
■ HPV-16	MMab	CAMVIR-1
HSP-27	MMab	G3.1
IgA	MMab	BSB-39
IgD	RPab	Polyclonal
IgD	RMab	EP173
IgG	MMab	BSB-40
IgG4	MMab	BSB-96
IgG4	RMab	EP138
IgM	MMab	BSB-41
IMP-3/1GF2BP3	RMab	EP286
* Inhibin Alpha	MMab	R1
Inhibin Alpha	RMab	EP378
INI-1	MMab	25
iNOS	RMab	RBT-iNOS
Insulin	MMab	BSB-42
Insulin	RMab	EP125
Islet-1/ISL1	RMab	EP283
Kappa Light Chains	MMab	BSB-58
Ki-67	RMab	EP5
Ksp-Cadherin	MMab	4H6/F9
* LAG-3	RMab	EP294
Lambda	MMab	BSB-16
Langerin	MMab	12D6
* Langerin/CD2-7	RMab	EP349
* LEF-1	RMab	EP310
LH	MMab	BSB-16
Macrophage/HAM-56	MMab	HAM-56
Mammaglobin	RMab	EP249
MART-1/Melan-A, M2-7C10	MMab	M2-7C10
MART-1/Melan-A, A103	MMab	A103
Maspin	MMab	BSB-92
MCM2	RMab	RBT-MCM2
MCM3	RMab	EP202

ANTIBODY	ANTIBODY TYPE	CLONE
MCM5	RMab	RBT-MCM5
MDM2	MMab	BSB-64
MDR-1	MMab	JSB-1
MDR-1	RMab	EP271
Melanoma/KBA.62	MMab	KBA6.2
Melanoma/PNL2	MMab	PNL2
Melanoma Cocktail	MMab	HMB-45, A103 & BSB-6
Melanosome HMB-45	MMab	HMB-45
* Mesothelial	MMab	HBME-1
Mesothelial	RMab	EP140
MITF	MMab	CS/D5
MLH1	MMab	G168-728
MMP-9	RMab	EP127
MSH2	MMab	G219-1129
MSH2	RMab	RBT-MSH2
MSH6	MMab	44
MSH6	RMab	EP287
■ Mycobacterium Tuberculosis	RPab	Polyclonal
Myelin Basic Protein	RPab	N/A
Myelin Basic Protein	RMab	EP207
Myeloperoxidase	RPab	N/A
Myeloperoxidase	RMab	EP151
MyoD1	RMab	EP212
Myogenin	MMab	F5D
Myogenin	RMab	EP162
* Myoglobin	MMab	BSB-104
Myoglobin	RPab	N/A
Myoglobin	RMab	EP87
Myosin, Smooth Muscle Heavy Chain	MMab	BSB-17
* Napsin A	MMab	BSB-112
Napsin A	RMab	EP205
Nestin	RMab	EP287
NeuN	MMab	A60
Neuroblastoma	RMab	NB84a
Neutrophil Elastase	RMab	EP223
Neurofilament	MMab	2F11
Neurofilament	RMab	EP79
NGFR	MMab	BSB-18
NKX2.2	RMab	EP336
R1	RMab	EP356
NKX3.1	RMab	EP378
NRAS (Q61R)	RMab	25
NSE	MMab	BSB-94
OCT-2	RMab	EP115
OCT-4	RMab	EP143
OLIG2	RMab	EP112
Osteonectin/SPARC	MMab	BSB-93
■ OX40/CD134	MMab	BSB-90
P21	MMab	DCS-60.2
P27	MMab	SX53G8
P40	RMab	ZR8
P53	MMab	DO7
p57	MMab	KP10
P63	RMab	EP174
P120 Catenin	RMab	EP66
Parafibromin	MMab	BSB-50
Parathyroid Hormone/PTH	MMab	BSB-24
* Parvalbumin	RMab	EP300
■ Parvovirus	MMab	R92F6
PAX-2	RMab	EP235
PAX-5	RMab	RBT-PAX-5
PAX-6	RMab	EP341

ANTIBODY	ANTIBODY TYPE	CLONE
PAX-8	RMab	EP298
PAX-8	RMab	ZR-1
PD-1/CD279	MMab	NAT-105
PD-1/CD279	RMab	EP239
PD-L1/CD274	RMab	RBT-PDL1
PDGFR-B	RMab	RBT-PDGFRB
PDX1	RMab	EP139
Perforin	MMab	5B10
PGP 9.5	MMab	BSB-46
PLAP	MMab	BSB-47
PLAP	RMab	EP194
PMS2	RMab	EP51
■ Pneumocystis jirovecii	MMab	3F6
Podoplanin/d2-40	MMab	D2-40
■ Progesterone Receptor	MMab	BSB-2
■ Progesterone Receptor	RMab	RBT22
■ Progesterone Receptor	RMab	EP2
Prolactin	MMab	PRL02
Prolactin	RMab	EP193
Prostein/P501S	RMab	ZR-9
PSA	MMab	BSB-7
PSA	RMab	RBT-PSA
PSAP	MMab	PA5E/4LJ
PSAP	RMab	EP53
PSMA	RMab	EP192
PSP94/MSMB	RMab	EP203
PTEN	MMab	6H2.1
PTEN	RMab	RBT-PTEN
PTH	MMab	BSB-24
PU.1	RMab	EP18
Retinoblastoma	MMab	1F8
S100	MMab	4C4.9
S100 Beta	RMab	EP32
S100A1	RMab	EP184
S100A6	RMab	EP313
S100A8/MRP8	RMab	EP90
S100A9	RMab	EP185
S100P	RMab	EP186
SALL4	MMab	6E3
SALL4	RMab	EP299
SATB2f	RMab	EP281
SMAD4/DPC4	MMab	BSB-63
* SMAD4/DPC4	RMab	RBT-SMAD4
Smoothelin	MMab	R4A
* Somatostatin	MMab	BSB-113
Somatostatin	RPab	N/A
Somatostatin	RMab	EP130
SOX-2	RMab	EP103
SOX-9	RMab	EP317
SOX-10	MMab	BSB-62
SOX-10	RMab	EP268
SOX-11	MMab	CL0142
Spectrin	MMab	RBC2/3D5
Spectrin	RMab	EP251
* STAT6	RMab	EP325
STAT6	RPab	Polyclonal
Stathmin	RMab	EP247
Survivin	RMab	EP119
■ SV40	MMab	Pab101
Synaptophysin	RPab	Polyclonal

QUICK GUIDE REFERENCE
 * NEW ANTIBODIES ■ ASR ■ RUQ

PLEASE NOTE: All antibodies are IVD unless otherwise specified.

All Antibodies Available
Concentrate and Predilute

ANTIBODY	ANTIBODY TYPE	CLONE
Synaptophysin	RMab	EP158
T-Bet/TBX-21	RMab	EP263
TAG-72	MMab	BSB-21
* Tau	MMab	BSB-115
TCL1	RMab	EP105
TCCR Beta F1	MMab	8A3
TdT	RPab	N/A
TdT	RMab	EP266
TdT	RMab	RBT-TdT
TFE3	RPab	Polyclonal
TFE3	RMab	EP285
Thrombomodulin/CD141	RMab	EP175
Thyroglobulin	MMab	BSB-49
Thyroglobulin	MMab	2H11/6E1
Thyroglobulin	RMab	EP250
Thyroid Peroxidase	RMab	EP159
TIA-1	MMab	TIA-1
Topoisomerase IIa	RMab	RBT-Topo2a
Toxoplasma gondii	RPab	N/A
TRAcP	MMab	9C5
Treponema Pallidum	RPab	Polyclonal
Tryptase	MMab	G3
Tryptase	RMab	EP259
TSH	MMab	BSB-56
TSH	RMab	EP254
TTF-1	MMab	8G7G3/1
Tyrosinase	MMab	BSB-6
Uroplakin III	RPab	Polyclonal
Uroplakin III	RMab	EP321
Varicella Zoster Virus	MMab	SG1-1, SG1-SG4, NCP & IE62
VEGF	RMab	RBT-VEGF
Villin	MMab	CWVWB1
Villin	RMab	EP163
Vimentin	MMab	V9
Vimentin	RMab	EP21
WT-1	MMab	6F-H2
Zap-70	MMab	2F3.2

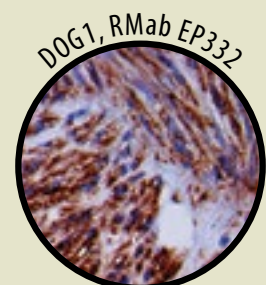
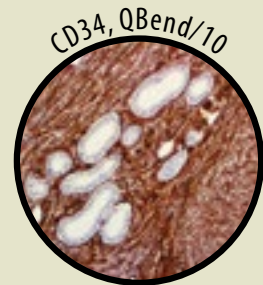
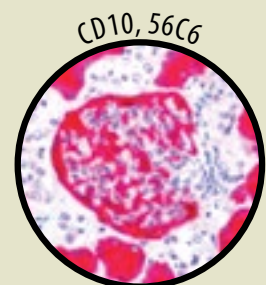

Antibodies by Application

Breast Cancer Antibodies

ANTIBODY	ANTIBODY TYPE	CLONE
Actin, Smooth Muscle	MMab	BSB-15
ALDH1A1	RMab	EP168
Androgen Receptor	MMab	BSB-4 (AR-D12)
■ B7H3/CD276	RMab	RBT-B7H3
Bax	RMab	E63
BCA-225	MMab	Cu-118
bcl-2	MMab	BSB-5
bcl-2	RMab	EP36
Bclx	RMab	EP94
Beta-Catenin	MMab	14
Beta-Catenin	RMab	EP35
c-MET/HGFR	RMab	EP1454Y
CA-125	MMab	OC125
CA-125	RMab	EP48
Caldesmon	MMab	BSB-19
Calponin	MMab	BSB-20
CA15-3	RMab	DF3
CD10	MMab	56C6
CD10	RMab	EP195
CD31	MMab	1A10
CD44	MMab	BSB-12
CD45RA	MMab	4KB5
CD68	MMab	BSB-8
CD68	MMab	KP-1
CD105/Endoglin	RPab	Polyclonal
CD105	RMab	EP274
CDK2	RMab	RBT-CDK2
Claudin-1	RPab	Polyclonal
Claudin-5	RMab	EP224
Clusterin/Apolipoprotein J	RMab	EP181
Collagen Type IV	MMab	CIV22
Cyclin B1	RMab	RBT-B1
Cyclin D1	RMab	RBT14
Cyclin E1	RMab	EP126
Cytokeratin 5	RMab	EP24
Cytokeratin 5 & 6	RMab	D5/16B4
Cytokeratin 5 & 6	RMab	EP24 & EP67
Cytokeratin 5 & 14	RMab	EP24 & EP61
Cytokeratin 7	MMab	OV-TL 12/30
Cytokeratin 7	RMab	EP16
Cytokeratin 7	RMab	EP17
Cytokeratin 8	RMab	EP17
Cytokeratin 14	RMab	EP61
Cytokeratin 15	RMab	EP14
Cytokeratin 17	MMab	BSB-33
Cytokeratin 17	RMab	EP98
Cytokeratin 18	RMab	EP30
Cytokeratin 19	MMab	BSB-34
Cytokeratin 19	RMab	EP72
Cytokeratin 35BH11	MMab	35betaH11
Cytokeratin Cocktail AE1&AE3	MMab	AE1/AE3
Cytokeratin LMW/AE1	MMab	AE1
Cytokeratin OSCAR	MMab	OSCAR
E-Cadherin	RMab	EP6

QUICK GUIDE REFERENCE
 * NEW ANTIBODIES ■ ASR ■ RUQ

PLEASE NOTE: All antibodies are IVD unless otherwise specified.

All Antibodies Available
Concentrate and Predilute

Breast Cancer Antibodies

ANTIBODY	ANTIBODY TYPE	CLONE
■ EGFR	MMab	31G7
■ EGFR Phospho	RMab	EP11
EMA	MMab	E29
■ Estrogen Receptor	MMab	BSB-1
■ Estrogen Receptor	RMab	RBT11
FOXA1/HNF-3A	RPab	Polyclonal
FOXA1/HNF-3A	RMab	EP277
FOXP1	RMab	EP137
FOXP3	RPab	Polyclonal
FOXP3	RMab	EP340
GATA 3	MMab	L50-823
GATA 3	RMab	EP368
GCDFP-15	MMab	23A3
GCDFP-15	RMab	EP95
■ HER-2 neu	MMab	BSB-3
■ HER-2 neu	RMab	EP3
■ HER-2 neu	RMab	RBT-HER2
■ HER-2 neu Phospho	RMab	EP123
HLA-DR alpha chain	RMab	EP96
HLA-DRB1 beta chain	RMab	EP191
HSP-27	MMab	G3.1
Ki-67	RMab	EP5
Mammaglobin	RMab	EP249
Maspin	MMab	BSB-92
MCM3	RMab	EP202
MDM2	MMab	BSB-64
MDR-1	MMab	JSB-1
MDR-1	RMab	EP271
MMP-9	RMab	EP127
MUC1	MMab	BSB-44
MUC1	RMab	EP85
Myosin, Smooth Muscle Heavy Chain	MMab	BSB-17
Nestin	RMab	EP287
NGFR	MMab	BSB-18
NKX3.1	RMab	EP356
Osteonectin/SPARC	MMab	BSB-93
P27	MMab	SX53G8
P40	RMab	ZR8
P53	MMab	DO7
P63	RMab	EP174
P120 Catenin	RMab	EP66
Progesterone Receptor	MMab	BSB-2
Progesterone Receptor	RMab	RBT22
Progesterone Receptor	RMab	EP2
PTEN	MMab	6H2.1
PTEN	RMab	RBT-PTEN
S100A8/MRP8	RMab	EP90
S100A9	RMab	EP185
SALL4	MMab	6E3
SALL4	RMab	EP299
Survivin	RMab	EP119
TAG-72	MMab	BSB-21
Topoisomerase IIa	RMab	RBT-Topo2a

Carcinoma Unknown Primary Site

ANTIBODY	ANTIBODY TYPE	CLONE
Cadherin 17/Li-Cadherin	RMab	EP86
CDX2	RMab	EP25
CEA	MMab	BSB-13
CEA	RPab	Polyclonal
Cytokeratin 5	RMab	EP24
Cytokeratin 7	MMab	OV-TL 12/30
Cytokeratin 7	RMab	EP16
Cytokeratin 17	MMab	BSB-33
Cytokeratin 17	RMab	EP98
Cytokeratin Cocktail AE1&AE3	MMab	AE1/AE3
Cytokeratin LMW CAM5.2	MMab	CAM5.2
Cytokeratin OSCAR	MMab	OSCAR
Estrogen Receptor	MMab	BSB-1
Estrogen Receptor	RMab	RBT11
GATA 3	MMab	L50-823
* GATA 3	RMab	EP368
GCDFFP-15	RMab	EP95
Hepatocyte Specific Antigen/ Hep Par 1	MMab	OCH1E5
Mammaglobin	RMab	EP249
* Napsin A	MMab	BSB-112
NKX3.1	RMab	EP356
P40	RMab	ZR8
P63	RMab	EP174
PAX-6	RMab	EP341
PAX-8	RMab	EP298
PAX-8	RMab	ZR-1
Progesterone Receptor	MMab	BSB-2
Progesterone Receptor	RMab	RBT22
Progesterone Receptor	RMab	EP2
Prostein/P501S	RMab	ZR-9
PSA	MMab	BSB-7
PSA	RMab	RBT-PSA
S100	MMab	4C4.9
Synaptophysin	RPab	Polyclonal
Synaptophysin	RMab	EP158
TFE3	RMab	EP285
TTF-1	MMab	8G7G3/1
WT-1	MMab	6F-H2

Cervical Antibodies

ANTIBODY	ANTIBODY TYPE	CLONE
CA-125	MMab	OC125
CA-125	RMab	EP48
CD45RA	MMab	4KB5
CD117	RMab	EP10
Clusterin/Apolipoprotein J	RMab	EP181
Cyclin B1	RMab	RBT-B1
Cyclin E1	RMab	EP126
Cytokeratin 16	RMab	EP297
Cytokeratin 17	MMab	BSB-33
Cytokeratin 17	RMab	EP98
FOXO1	RMab	EP290
HIF-1a	RMab	EP118

QUICK GUIDE REFERENCE
 * NEW ANTIBODIES ■ ASR ■ RUO

Cervical Antibodies

ANTIBODY	ANTIBODY TYPE	CLONE
■ HPV	MMab	BSB-66
■ HPV-16	MMab	CAMVIR-1
HSP-27	MMab	G3.1
IMP-3/1GF2BP3	RMab	EP286
Ki-67	RMab	EP5
MCM2	RMab	RBT-MCM2
MCM3	RMab	EP202
MCM5	RMab	RBT-MCM5
MUC4	MMab	8G7
MUC4	RMab	EP256
P63	RMab	EP174
Stathmin	RMab	EP247
Topoisomerase IIa	RMab	RBT-Topo2a
■ VEGF	RMab	RBT-VEGF

Colon & G.I. Antibodies

ANTIBODY	ANTIBODY TYPE	CLONE
Actin, Smooth Muscle	MMab	BSB-15
ALDH1A1	RMab	EP168
Beta-Catenin	MMab	14
Beta-Catenin	RMab	EP35
■ BRAF V600E	RMab	RM8
c-MET/HGFR	RMab	EP1454Y
Cadherin 17/Li-Cadherin	RMab	EP86
Carbonic Anhydrase 9	RMab	EP161
CA 19-9	MMab	121SLE
CD34	MMab	QBEnd/10
CD34	RMab	EP88
CD44	MMab	BSB-12
CD45RA	MMab	4KB5
CD45RO	MMab	UCHL-1
CD103/ITGAE	RMab	EP206
CD105/Endoglin	RPab	Polyclonal
CD105	RMab	EP274
CD117	RMab	EP10
CDX2	RMab	EP25
CEA	MMab	BSB-13
CEA	RPab	Polyclonal
Chromogranin A	MMab	LK2H10
Claudin-1	RPab	Polyclonal
COX-2	RMab	EP293
COX-2	RMab	RBT-COX2
Cyclin E1	RMab	EP126
Cytokeratin 4	RMab	EP4
Cytokeratin 7	MMab	OV-TL 12/30
Cytokeratin 7	RMab	EP16
Cytokeratin 7 & CDX2	RMab	EP16 & EP25
Cytokeratin 8 & 18	RMab	EP17/EP30
Cytokeratin 18	RMab	EP30
Cytokeratin 19	MMab	BSB-34
Cytokeratin 19	RMab	EP72
Cytokeratin 20	MMab	Ks20.8
Cytokeratin 20	RMab	EP23
Cytokeratin 35BH11	MMab	35betaH11
Cytokeratin LMW CAM5.2	MMab	CAM5.2
DOG1	RMab	EP332

PLEASE NOTE: All antibodies are IVD unless otherwise specified.

All Antibodies Available
Concentrate and Predilute

Colon & G.I. Antibodies Cont.

ANTIBODY	ANTIBODY TYPE	CLONE
Cytokeratin 7	RMab	EP16
Cytokeratin 7 & CDX2	RMab	EP16 & EP25
Cytokeratin 8 & 18	RMab	EP17/EP30
Cytokeratin 18	RMab	EP30
Cytokeratin 19	MMab	BSB-34
Cytokeratin 19	RMab	EP72
Cytokeratin 20	MMab	Ks20.8
Cytokeratin 20	RMab	EP23
Cytokeratin 35BH11	MMab	35betaH11
Cytokeratin LMW CAM5.2	MMab	CAM5.2
DOG1	RMab	EP332
DOG1	RMab	RBT-DOG1
■ EGFR	MMab	31G7
■ EGFR Phospho	RMab	EP11
EpCAM/Epithelial Specific Antigen	MMab	BerEP4
EPCAM/Epithelial Specific Antigen	MMab	MOC-31
■ Helicobacter pylori	MMab	BSB-37
■ Helicobacter pylori	RPab	Polyclonal
■ HER-2 neu	MMab	BSB-3
■ HER-2 neu	RMab	EP3
■ HER-2 neu	RMab	RBT-HER2
■ HER-2 neu Phospho	RMab	EP123
HLA-DRB1 beta chain	RMab	EP191
IgG4	MMab	BSB-96
IMP-3/1GF2BP3	RMab	EP286
Ki-67	RMab	EP5
* LEF-1	RMab	EP310
Maspin	MMab	BSB-92
MLH1	MMab	G168-728
MMP-9	RMab	EP127
MSH2	MMab	G219-1129
MSH2	RMab	RBT-MSH2
MSH6	MMab	44
MUC1	MMab	BSB-44
MUC1	RMab	EP85
MUC2	MMab	BSB-45
MUC2	RMab	EP187
MUC4	MMab	8G7
MUC4	RMab	EP256
MUC5AC	MMab	CLH2
MUC6	MMab	CLH5
Osteonectin/SPARC	MMab	BSB-93
P53	MMab	BSB-93
PAX-5	RMab	RBT-PAX-5
PAX-6	RMab	EP341
PDX1	RMab	EP139
PGP 9.5	MMab	BSB-46
PMS2	RMab	EP51
S100A6	RMab	EP313
S100P	RMab	EP186
SALL4	MMab	6E3
SALL4	RMab	EP299
SATB2f	RMab	EP281
* SMAD4/DPC4	MMab	BSB-63
* SMAD4/DPC4	RMab	RBT-SMAD4
Somatostatin	MMab	BSB-113
Somatostatin	RMab	EP130
SOX-9	RMab	EP317
Synaptophysin	RPab	Polyclonal

QUICK GUIDE REFERENCE
 * NEW ANTIBODIES ■ ASR ■ RUO

PLEASE NOTE: All antibodies are IVD unless otherwise specified.

Colon & G.I. Antibodies Cont.

ANTIBODY	ANTIBODY TYPE	CLONE
Synaptophysin	RMab	EP158
Villin	MMab	CWWB1
Villin	RMab	EP163
Synaptophysin	RMab	EP158
Villin	MMab	CWWB1
Villin	RMab	EP163

Endometrial & Genital Antibodies

ANTIBODY	ANTIBODY TYPE	CLONE
bcl-2	MMab	BSB-5
bcl-2	RMab	EP36
CD10	MMab	56C6
CD10	RMab	EP195
CD44	MMab	BSB-12
Cyclin D1	RMab	EP12
Cyclin D1	RMab	RBT14
Cyclin E1	RMab	EP126
Estrogen Receptor	MMab	BSB-1
Estrogen Receptor	RMab	EP1
Estrogen Receptor	RMab	RBT1
hPL	RMab	EP241
hPL	RPab	Polyclonal
IMP-3/1GF2BP3	RMab	EP286
* Inhibin Alpha	RMab	EP378
MUC4	RMab	EP256
P21	MMab	DCS-60.2
P53	MMab	DO7
Progesterone Receptor	MMab	BSB-2
Progesterone Receptor	RMab	RBT22
Progesterone Receptor	RMab	EP2
PTEN	MMab	6H2.1
PTEN	RMab	RBT-PTEN
Retinoblastoma	MMab	1F8
SALL4	MMab	6E3
SALL4	RMab	EP299
Stathmin	RMab	EP247
Vimentin	MMab	V9
Vimentin	RMab	EP21

Endothelial

ANTIBODY	ANTIBODY TYPE	CLONE
DO7	MMab	DO7
ALDH1A1	RMab	EP168
CD31	MMab	1A10
CD34	MMab	QBEnd/10
CD34	RMab	EP88
CD105/Endoglin	RPab	Polyclonal
CD105	RMab	EP274
Claudin-5	RMab	EP224
ERG	RMab	EP1111
Fli-1	MMab	G146-222
Podoplanin/d2-40	MMab	D2-40
■ VEGF	RMab	RBT-VEGF

All Antibodies Available
Concentrate and Predilute

Gall Bladder + Pancreatic

ANTIBODY	ANTIBODY TYPE	CLONE
* B7H3/CD276	RMab	RBT-B7H3
■ bcl-6	MMab	BSB-26
bcl-6	RMab	EP278
bcl-10	MMab	BSB-22
Beta-Catenin	RMab	EP35
Cadherin 17/Li-Cadherin	RMab	EP86
CA 19-9	MMab	121SLE
CD10	MMab	56C6
CDX2	RMab	EP25
CEA	MMab	BSB-13
CEA	RPab	Polyclonal
Chromogranin A	MMab	LK2H10
Collagen Type IV	MMab	CIV22
Cytokeratin 17	MMab	BSB-33
Cytokeratin 17	RMab	EP98
Cytokeratin 35BH11	MMab	35betaH11
Cytokeratin LMW CAM5.2	MMab	CAM5.2
Gastrin	RPab	N/A
* Glucagon	MMab	BSB-111
Glucagon	RPab	Polyclonal
Glucagon	RMab	EP74
* HE4	RMab	EP370
IgG4	MMab	BSB-96
IgG4	RMab	EP138
Insulin	MMab	BSB-42
Insulin	RMab	EP125
Islet-1/ISL1	RMab	EP283
Maspin	MMab	BSB-92
* Mesothelial	MMab	HBME-1
Mesothelial	RMab	EP140
* MUC4	MMab	8G7
MUC4	RMab	EP256
Osteonectin/SPARC	MMab	BSB-93
PAX-6	RMab	EP341
PDX1	RMab	EP139
PGP 9.5	MMab	BSB-46
S100A6	RMab	EP313
S100A8/MRP8	RMab	EP90
S100P	RMab	EP186
* SMAD4/DPC4	MMab	BSB-63
* SMAD4/DPC4	RMab	RBT-SMAD4
Somatostatin	MMab	BSB-113
Somatostatin	RPab	N/A
Somatostatin	RMab	EP130
SOX-9	RMab	EP317
Synaptophysin	RMab	EP158
Synaptophysin	RPab	Polyclonal
TAG-72	MMab	BSB-21
Villin	MMab	CVVWB1
Villin	RMab	EP163

QUICK GUIDE REFERENCE

* NEW ANTIBODIES ■ ASR ■ RUO

Germ Cell Tumor

ANTIBODY	ANTIBODY TYPE	CLONE
Alpha-Fetaprotein	MMab	BSB-23
Alpha-Fetaprotein	RMab	EP209
CD117	RMab	EP10
Cytokeratin Cocktail AE1&AE3	MMab	AE1/AE3
Cytokeratin OSCAR	MMab	OSCAR
FOXP1	RMab	EP137
GCDFP-15	MMab	23A3
Glypican-3	MMab	1G12
hCG	MMab	BSB-38
OCT-4	RMab	EP143
p57	MMab	KP10
PLAP	MMab	BSB-47
PLAP	RMab	EP194
SALL4	MMab	6E3
SALL4	RMab	EP299
SOX-2	RMab	EP103

Gist

ANTIBODY	ANTIBODY TYPE	CLONE
CD34	MMab	QBEnd/10
CD34	RMab	EP88
CD117	RMab	EP10
Desmin	MMab	D33
DOG1	RMab	EP332
DOG1	RMab	RBT-DOG1
S100	MMab	4C4.9
S100 Beta	RMab	EP32

Head & Neck

ANTIBODY	ANTIBODY TYPE	CLONE
Androgen Receptor	MMab	BSB-4 (AR-D12)
Calcitonin	RPab	N/A
Calcitonin	RMab	EP92
Caldesmon	MMab	BSB-19
CD117	RMab	EP10
Cyclin E1	RMab	EP126
Cytokeratin 7	MMab	OV-TL 12/30
Cytokeratin 7	RMab	EP16
Desmoglein-3	MMab	BSB-61
Desmoglein-3	RMab	EP306
DOG1	RMab	EP332
DOG1	RMab	RBT-DOG1
Galectin-3	MMab	9C4
GFAP	MMab	G-A-5
GFAP	RMab	EP13
■ HPV	MMab	BSB-66
HSP-27	MMab	G3.1
MCM3	RMab	EP202
Mesothelial	MMab	HBME-1
P63	RMab	EP174
Parathyroid Hormone/PTH	MMab	BSB-24
SOX-10	MMab	BSB-62
* Thyroglobulin	MMab	BSB-49
Thyroglobulin	MMab	2H11/6E1
Thyroglobulin	RMab	EP250
Thyroid Peroxidase	RMab	EP159

PLEASE NOTE: All antibodies are IVD unless otherwise specified.

All Antibodies Available
Concentrate and Predilute

Hematopoietic

ANTIBODY	ANTIBODY TYPE	CLONE
CD31	MMab	1A10
CD34	MMab	QBEnd/10
CD34	RMab	EP88
CD41/Integrin alpha IIb	RMab	EP178
CD138	MMab	B-A38
CD138	RMab	EP201
Clusterin/Apolipoprotein J	RMab	EP181
Fli-1	MMab	G146-222
Glycophorin-A	MMab	GA-R2
Tryptase	MMab	G3
Tryptase	RMab	EP259

Hodgkin's & NHD Lymphoma

ANTIBODY	ANTIBODY TYPE	CLONE
* bcl-6	MMab	BSB-26
bcl-6	RMab	EP278
bcl-6	RMab	RBT-bcl6
BOB.1	RMab	EP114
CD3 Epsilon	RMab	RBT-CD3e
CD3	RMab	RBT-CD3
CD10	MMab	56C6
CD10	RMab	EP195
CD15	MMab	MMA
CD15	RMab	EP272
CD19	MMab	BSB-97
CD19	RMab	EP169
CD20	MMab	L26
CD21	RMab	EP64
CD23	MMab	1B12
CD23	RMab	EP75
CD30	MMab	Ber-H2
CD45	MMab	2B11 & PD7/26
CD57	MMab	BSB-10
CD79a	MMab	JCB117
Cyclin E1	RMab	EP126
■ Epstein Barr Virus, LMP-1	MMab	CS1-4
Fascin	MMab	BSB-36
FOXO1	RMab	EP290
FOXP3	RPab	Polyclonal
FOXP3	RMab	EP340
Granzyme B	RPab	Polyclonal
Granzyme B	RMab	EP230
hGAL.GCET2	RMab	EP316
IgA	MMab	BSB-39
IgD	RPab	Polyclonal
IgD	RMab	EP173
IgG	MMab	BSB-40
IgM	MMab	BSB-41
* LAG-3	RMab	EP294
MUM-1	RMab	EP190
OCT-2	RMab	EP115
PAX-5	RMab	RBT-PAX-5
PD-1/CD279	MMab	NAT-105
PD-1/CD279	RMab	EP239
PD-L1/CD274	RMab	RBT-PDL1
PU.1	RMab	EP18
TIA-1	MMab	TIA-1

QUICK GUIDE REFERENCE

* NEW ANTIBODIES ■ ASR ■ RUO

PLEASE NOTE: All antibodies are IVD unless otherwise specified.

All Antibodies Available
Concentrate and Predilute

Immunotherapy

ANTIBODY	ANTIBODY TYPE	CLONE
■ B7H3/CD276	RMab	RBT-B7H3
CD8	MMab	C8/144B
CD8	RMab	EP334
■ CTLA-4/CD152	MMab	BSB-88
FOXP3	RPab	Polyclonal
FOXP3	RMab	EP340
Granzyme B	RPab	Polyclonal
Granzyme B	RMab	EP230
* LAG-3	RMab	EP294
■ OX40/CD134	MMab	BSB-90
PD-1/CD279	MMab	NAT-105
PD-1/CD279	RMab	EP239
PD-L1/CD274	RMab	RBT-PDL1

Infectious Disease

ANTIBODY	ANTIBODY TYPE	CLONE
■ Adenovirus	MMab	20/11 & 2/6
■ Cytomegalovirus	MMab	8B1.2, 1G5.2&2D4.2
■ Epstein Barr Virus, LMP-1	MMab	CS1-4
■ Helicobacter pylori	MMab	BSB-37
■ Helicobacter pylori	RPab	Polyclonal
■ Helicobacter pylori	RMab	EP279
■ Hepatitis B Virus Core	RPab	Polyclonal
■ Hepatitis B Virus Surface Antigen	MMab	T9
■ Herpes Simplex Virus I	RPab	Polyclonal
■ Herpes Simplex Virus I	MMab	10A3
■ Herpes Simplex Virus II	RPab	Polyclonal
■ Herpes Simplex Virus II	MMab	BSB-116
* ■ Herpes Simplex Virus I & II	RPab	Polyclonal
* ■ Herpes Simplex Virus I & II	MMab	10A3 / BSB116
■ HHV-8	MMab	13B10
■ HPV	MMab	BSB-66
■ HPV-16	MMab	CAMVIR-1
■ Mycobacterium Tuberculosis	RPab	Polyclonal
■ Parvovirus	MMab	R92F6
■ Pneumocystis jirovecii	MMab	3F6
■ SV40	MMab	Pab101
■ Toxoplasma gondii	RPab	N/A
■ Treponema Pallidum	RPab	Polyclonal
■ Varicella Zoster Virus	MMab	SG1-1, SG1-SG4, NCP & 1E62

Kidney & Urothelial

ANTIBODY	ANTIBODY TYPE	CLONE
AMACRacemase/P504S	RMab	13H4
Amyloid A	RMab	EP335
* BAP1	MMab	BSB-109
c-MET/HGFR	RMab	EP1454Y
C3d	RPab	Polyclonal
C4d	RPab	Polyclonal
C4d	RMab	EP273
Carbonic Anhydrase 9	RMab	EP161
CD10	MMab	56C6
CD10	RMab	EP195
CD45RO	MMab	UCHL-1
CD57	MMab	BSB-10

QUICK GUIDE REFERENCE

* NEW ANTIBODIES ■ ASR ■ RUO

PLEASE NOTE: All antibodies are IVD unless otherwise specified.

All Antibodies Available
Concentrate and Predilute

Kidney & Urothelial

ANTIBODY	ANTIBODY TYPE	CLONE
CD61	MMab	2f2
CD63	MMab	NK1/C3
CD68	MMab	BSB-8
CD68	MMab	KP-1
CD75	MMab	LN1
CD105/Endoglin	RPab	Polyclonal
CD105	RMab	EP274
CD117	RMab	EP10
Cytokeratin 7	MMab	OV-TL 12/30
Cytokeratin 7	RMab	EP16
Cytokeratin 8 & 18	MMab	B22.1/B23.1
Cytokeratin 8 & 18	RMab	EP17/EP30
Cytokeratin 14	RMab	EP61
Cytokeratin 14	MMab	LL002
Cytokeratin 20	MMab	Ks20.8
Cytokeratin 20	RMab	EP23
Cytokeratin LMW CAM5.2	MMab	CAM5.2
E-Cadherin	RMab	EP6
ERG	RMab	EP1111
* Inhibin Alpha	RMab	EP378
Ksp-Cadherin	MMab	4H6/F9
Myoglobin	RPab	N/A
P63	RMab	EP174
* Parvalbumin	RMab	EP300
PAX-2	RMab	EP235
PAX-8	RMab	EP298
PAX-8	RMab	ZR-1
PD-L1/CD274	RMab	RBT-PDL1
S100A1	RMab	EP184
S100A6	RMab	EP313
Smoothelin	MMab	R4A
Survivin	RMab	EP19
TFE3	RPab	Polyclonal
Uroplakin III	RPab	Polyclonal
Uroplakin III	RMab	EP321
Vimentin	MMab	V9
Vimentin	RMab	EP21
WT-1	MMab	6F-H2

Leukemia/Histocytic

ANTIBODY	ANTIBODY TYPE	CLONE
Alpha-1-Antichymotrypsin	RPab	N/A
Alpha-1-Antitrypsin	RPab	N/A
ALDH1A1	RMab	EP168
Annexin A1	MMab	BSB-95
■ BRAF V600E	RMab	RM8
c-Myc	RMab	EP121
c-Myc	RPab	N/A
CD1a	RMab	EP80
CD5	RMab	RBT-CD5
CD5	RMab	RED1
CD7	MMab	LP15
CD7	RMab	EP132
CD8	MMab	C8/144B
CD8	RMab	EP334
CD11b	RMab	EP45
CD11c	RMab	EP157
CD13	MMab	38C12
CD13	RMab	EP117

QUICK GUIDE REFERENCE
 * NEW ANTIBODIES ■ ASR ■ RUO

Leukemia/Histocytic

ANTIBODY	ANTIBODY TYPE	CLONE
CD14	MMab	7
CD14	RMab	EP128
* CD16	RMab	EP364
CD19	MMab	BSB-97
CD19	RMab	EP169
CD20	MMab	L26
CD23	MMab	1B12
CD23	RMab	EP75
CD25	MMab	4C9
* CD33	RMab	RBT-CD33
CD34	MMab	QEnd/10
CD34	RMab	EP88
CD38	MMab	SPC32
CD38	RMab	EP135
CD45	MMab	2B11 & PD7/26
CD56	MMab	123C3.D5
CD61	MMab	2f2
CD68	MMab	BSB-8
CD68	MMab	KP-1
CD71	MMab	10F11
CD74	MMab	LN2
CD79a	MMab	JCB117
CD99	MMab	BSB-9
CD103/ITGAE	RMab	EP206
CD117	RMab	EP10
CD123, IL-3RA	MMab	BSB-59
CD163	MMab	10D6
CD163	RMab	EP324
Factor XIIIa	RMab	EP292
Glycophorin-A	MMab	GA-R2
Granzyme B	RPab	Polyclonal
Granzyme B	RMab	EP230
Hemaglobin A	RMab	EP124
Langerin	MMab	12D6
* Langerin/CD2-7	RMab	EP349
Macrophage/HAM-56	MMab	HAM-56
Myeloperoxidase	RPab	N/A
Myeloperoxidase	RMab	EP151
Neutrophil Elastase	RMab	EP223
PAX-5	RMab	RBT-PAX-5
PDGFR-B	RMab	RBT-PDGFRB
PU.1	RMab	EP18
Spectrin	MMab	RBC2/3D5
Spectrin	RMab	EP251
T-Bet/TBX-21	RMab	EP263
TCCL1	RMab	EP105
TCR Beta F1	MMab	8A3
TdT	RMab	EP266
TdT	RMab	RBT-TdT
TIA-1	MMab	TIA-1
TRAcP	MMab	9C5
Zap-70	MMab	2F3.2

Liver

ANTIBODY	ANTIBODY TYPE	CLONE
Alpha-1-Antichymotrypsin	RPab	N/A
Alpha-1-Antitrypsin	RPab	N/A
Alpha-Fetaprotein	MMab	BSB-23
Alpha-Fetaprotein	RMab	EP209

All Antibodies Available
 Concentrate and Predilute

PLEASE NOTE: All antibodies are IVD unless otherwise specified.

Liver cont.

ANTIBODY	ANTIBODY TYPE	CLONE
* BAP1	MMab	BSB-109
Beta-Catenin	MMab	14
Beta-Catenin	RMab	EP35
* Brachyury	RPab	Polyclonal
c-MET/HGFR	RMab	EP1454Y
CD10	MMab	56C6
CD10	RMab	EP195
CD13	MMab	38C12
CD13	RMab	EP117
CD25	MMab	4C9
CD25	RMab	RBT-CD25
CD34	MMab	QEnd/10
CD34	RMab	EP88
* CDK2	RMab	RBT-CDK2
CDX2	RMab	EP25
CEA	MMab	BSB-13
CEA	RPab	Polyclonal
Cytokeratin 8 & 18	MMab	B22.1/B23.1
Cytokeratin 8 & 18	RMab	EP17/EP30
Cytokeratin 19	MMab	BSB-34
Cytokeratin 19	RMab	EP72
Cytokeratin HMW 34BE12	MMab	34betaE12
Cytokeratin LMW CAM5.2	MMab	CAM5.2
EPCAM/Epithelial Specific Antigen	MMab	MOC-31
Glutamine Synthase	MMab	GS-6
Glypican-3	MMab	1G12
Hepatocyte Specific Antigen/ Hep Par 1	MMab	OCH1E5
HLA-DR alpha chain	RMab	EP96
P53	MMab	DO7
S100A9	RMab	EP185
SALL4	MMab	6E3
SALL4	RMab	EP299
SMAD4/DPC4	MMab	BSB-63
* SMAD4/DPC4	RMab	RBT-SMAD4
SOX-9	RMab	EP317
Survivin	RMab	EP119
TTF-1	MMab	8G7G3/1
■ VEGF	RMab	RBT-VEGF

Lung

ANTIBODY	ANTIBODY TYPE	CLONE
ALK-1	RMab	EP302
ALK-1	RMab	RBT-ALK1
Bax	RMab	E63
bcl-2	MMab	BSB-5
bcl-2	RMab	EP36
BG8 Lewis Y	MMab	F3
■ BRAF V600E	RMab	RM8
Calretinin	RMab	EP1798
CA15-3	RMab	DF3
CD14	MMab	7
CD14	RMab	EP128
CD15	MMab	MMA
CD15	RMab	EP272
CD56	MMab	123C3.D5
CD74	MMab	LN2
CD105/Endoglin	RPab	Polyclonal
CD105	RMab	EP274

QUICK GUIDE REFERENCE
 * NEW ANTIBODIES ■ ASR ■ RUO

PLEASE NOTE: All antibodies are IVD unless otherwise specified.

Lung cont.

ANTIBODY	ANTIBODY TYPE	CLONE
CDK2	RMab	RBT-CDK2
CDX2	RMab	EP25
CEA	MMab	BSB-13
CEA	RPab	Polyclonal
Chromogranin A	MMab	LK2H10
Claudin-5	RMab	EP224
Cyclin B1	RMab	RBT-B1
Cytokeratin 5	RMab	EP24
Cytokeratin 5 & 6	RMab	D5/16B4
Cytokeratin 5 & 6	RMab	EP24 & EP67
Cytokeratin 6	RMab	EP67
Cytokeratin 6 & CDKX2	RMab	EP16 & EP25
Cytokeratin 7	MMab	OV-TL 12/30
Cytokeratin 7	RMab	EP16
Cytokeratin 17	MMab	BSB-33
Cytokeratin 17	RMab	EP98
Cytokeratin 20	MMab	Ks20.8
Cytokeratin 20	RMab	EP23
Cytokeratin Cocktail AE1&AE3	MMab	AE1/AE3
Cytokeratin HMW/AE3	MMab	AE3
Cytokeratin LMW CAM5.2	MMab	CAM5.2
Cytokeratin LMW/AE1	MMab	AE1
Cytokeratin OSCAR	MMab	OSCAR
Desmoglein-3	MMab	BSB-61
Desmoglein-3	RMab	EP306
EGFR	MMab	31G7
■ EGFR Phospho	RMab	EP11
■ EMA	MMab	E29
EpCAM/Epithelial Specific Antigen	MMab	BerEP4
EPCAM/Epithelial Specific Antigen	MMab	MOC-31
ERC1	RMab	EP219
GLUT1	RMab	EP141
* HE4	RMab	EP370
HLA-DR alpha chain	RMab	EP96
1MP-3/1GF2BP3	RMab	EP286
Ki-67	RMab	EP5
Maspin	MMab	BSB-92
* Mesothelial	MMab	HBME-1
Mesothelial	RMab	EP140
MUC4	MMab	8G7
MUC4	RMab	EP256
* Napsin A	MMab	BSB-112
Napsin A	RMab	EP205
NSE	MMab	BSB-94
P40	RMab	ZR8
P63	RMab	EP174
PAX-6	RMab	EP341
PD-L1/CD274	RMab	RBT-PDL1
PGP 9.5	MMab	BSB-46
Podoplanin/d2-40	MMab	D2-40
S100A9	RMab	EP185
S100P	RMab	EP186
SOX-2	RMab	EP103
SOX-9	RMab	EP317
SOX-11	MMab	CL0142
STAT6	RMab	EP325
STAT6	RPab	Polyclonal
STAT6	RMab	Polyclonal
Synaptophysin	RPab	Polyclonal
Synaptophysin	RMab	EP158
TTF-1	MMab	8G7G3/1
WT-1	MMab	6F-H2

All Antibodies Available
 Concentrate and Predilute

Lymphoma

ANTIBODY	ANTIBODY TYPE	CLONE
ALDH1A1	RMab	EP168
ALK-1	RMab	EP302
ALK-1	RMab	RBT-ALK1
bcl-2	MMab	BSB-5
bcl-2	RMab	EP36
bcl-6	MMab	BSB-26
* bcl-6	RMab	EP278
bcl-6	RMab	RBT-bcl6
bcl-10	MMab	BSB-22
BOB.1	RMab	EP114
■ BRAF V600E	RMab	RM8
c-Myc	MMab	9E10
c-Myc	RMab	EP121
CD1a	RMab	EP80
CD2	MMab	AB75
CD3 Epsilon	RMab	RBT-CD3e
CD3	RMab	RBT-CD3
CD4	RMab	RBT-CD4
CD5	RMab	RBT-CD5
CD5	RMab	RED1
CD6	MMab	BSB-54
CD7	MMab	LP15
CD7	RMab	EP132
CD8	MMab	C8/144B
CD8	RMab	EP334
CD10	MMab	56C6
CD10	RMab	EP195
CD14	MMab	7
CD14	RMab	EP128
CD15	MMab	MMA
CD15	RMab	EP272
* CD16	RMab	EP364
CD19	MMab	BSB-97
CD19	RMab	EP169
CD20	MMab	L26
CD21	RMab	EP64
CD23	MMab	1B12
CD23	RMab	EP75
CD25	MMab	4C9
CD25	RMab	RBT-CD25
CD30	MMab	Ber-H2
CD35	MMab	RLB25
CD35	RMab	EP197
CD38	MMab	SPC32
CD38	RMab	EP135
CD43	MMab	MT1
CD45	MMab	2B11 & PD7/26
CD45R	MMab	MB1
CD45RO	MMab	UCHL-1
CD56	MMab	123C3.D5
CD57	MMab	BSB-10
CD74	MMab	LN2
CD75	MMab	LN1
CD79a	MMab	JCB117
CD99	MMab	BSB-9
CD103/1TGAE	RMab	EP206
CD123, 1L-3RA	MMab	BSB-59
CD138	MMab	B-A38
CD138	RMab	EP201
■ CTLA-4/CD152	MMab	BSB-88
Cyclin D1	RMab	EP12

QUICK GUIDE REFERENCE

* NEW ANTIBODIES ■ ASR ■ RUO

Lymphoma Cont.

ANTIBODY	ANTIBODY TYPE	CLONE
Cyclin D1	RMab	RBT14
E2F4	RMab	EP252
■ Epstein Barr Virus, LMP-1	MMab	CS1-4
Fascin	MMab	BSB-36
Follicular Dendritic Cell	MMab	CAN.40
FOXP01	RMab	EP290
FOXP1	RMab	EP137
FOXP3	RPab	Polyclonal
FOXP3	RMab	EP340
Granzyme B	RPab	Polyclonal
Granzyme B	RMab	EP230
hGAL.GCET2	RMab	EP316
■ HHV-8	MMab	13B10
Histone H3 Phospho	RPab	Polyclonal
Histone H3 Phospho	RMab	EP233
IgA	MMab	BSB-39
IgD	RPab	Polyclonal
IgD	RMab	EP173
IgG	MMab	BSB-40
Kappa Light Chains	MMab	BSB-58
Ki-67	RMab	EP5
* LAG-3	RMab	EP294
Lambda	MMab	BSB-16
* LEF-1	RMab	EP310
MUM-1	RMab	EP190
OCT-2	RMab	EP115
PAX-5	RMab	RBT-PAX-5
PD-1/CD279	MMab	NAT-105
PD-1/CD279	RMab	EP239
PD-L1/CD274	RMab	RBT-PDL1
PU.1	RMab	EP18
SOX-11	MMab	CL0142
T-Ber/TBX-21	RMab	EP263
TCL1	RMab	EP105
TCR Beta F1	MMab	8A3
TdT	RPab	N/A
TdT	RMab	EP266
TdT	RMab	RBT-TdT
TIA-1	MMab	TIA-1
TRAcP	MMab	9C5
Zap-70	MMab	2F3.2
Adipophilin/ADRP	MMab	BSB91
■ B7H3/CD276	RMab	RBT-B7H3
* BAP1	MMab	BSB-109
■ BRAF V600E	RMab	RM8
CD4	RMab	RBT-CD4
CD8	MMab	C8/144B
CD8	RMab	EP334
CD25	MMab	4C9
CD25	RMab	RBT-CD25
CD41/Integrin alpha IIb	RMab	EP178
CD63	MMab	NK1/C3
CD163	MMab	10D6
CD163	RMab	EP324
Cytokeratin 5 & 6	RMab	D5/16B4
Cytokeratin 5 & 6	RMab	EP24 & EP67
Cytokeratin 7	MMab	OV-TL 12/30
Cytokeratin 7	RMab	EP16

Melanoma & Skin

ANTIBODY	ANTIBODY TYPE	CLONE
Melanosome HMB-45	MMab	HMB-45
MiTF	MMab	C5/D5
MLH1	MMab	G168-728
MSH2	MMab	G219-1129
MSH2	RMab	RBT-MSH2
MSH6	MMab	44
MSH6	RMab	EP49
Nestin	RMab	EP287
NGFR	MMab	BSB-18
NRAS (Q61R)	RMab	RBT-NRAS
■ OX40/CD134	MMab	BSB-90
P40	RMab	ZR8
P63	RMab	EP174
PD-L1/CD274	RMab	RBT-PDL1
PMS2	RMab	EP51
S100	MMab	4C4.9
S100 Beta	RMab	EP32
SOX-10	MMab	BSB-62
SOX-10	RMab	EP268
TIA-1	MMab	TIA-1
Tyrosinase	MMab	BSB-6
Vimentin	MMab	V9
Vimentin	RMab	EP21

Melanoma & Skin

ANTIBODY	ANTIBODY TYPE	CLONE
Cytokeratin 14	RMab	EP61
Cytokeratin 14	MMab	LL002
Cytokeratin 15	RMab	EP14
Cytokeratin 16	RMab	EP297
Cytokeratin HMW 34BE12	MMab	34betaE12
Cytokeratin HMW/AE3	MMab	AE3
Cytokeratin LMW/AE1	MMab	AE1
Cytokeratin OSCAR	MMab	OSCAR
Desmin	MMab	D33
Desmin	RMab	EP15
Desmoglein-3	MMab	BSB-61
Desmoglein-3	RMab	EP306
EpCAM/Epithelial Specific Antigen	MMab	BerEP4
Factor XIIIa	RMab	EP292
Glypican-3	MMab	IG12
Granzyme B	RPab	Polyclonal
Granzyme B	RMab	EP230
Histone H3 Phospho	RPab	Polyclonal
Histone H3 Phospho	RMab	EP233
IMP-3/1GF2BP3	RMab	EP286
Ki-67	RMab	EP5
MART-1/Melan-A, M2-7C10	MMab	M2-7C10
MART-1/Melan-A, A103	MMab	A103
Melanoma/KBA.62	MMab	KBA6.2
Melanoma/PNL2	MMab	PNL2
Melanoma Cocktail	MMab	HMB-45, A103 & BSB-6
Melanosome HMB-45	MMab	HMB-45
MiTF	MMab	C5/D5
MLH1	MMab	G168-728
MSH2	MMab	G219-1129
MSH2	RMab	RBT-MSH2
MSH6	MMab	44
MSH6	RMab	EP49
Nestin	RMab	EP287
NGFR	MMab	BSB-18
NRAS (Q61R)	RMab	RBT-NRAS
■ OX40/CD134	MMab	BSB-90
P40	RMab	ZR8
P63	RMab	EP174
PD-L1/CD274	RMab	RBT-PDL1
PMS2	RMab	EP51
S100	MMab	4C4.9
S100 Beta	RMab	EP32
SOX-10	MMab	BSB-62
SOX-10	RMab	EP268
TIA-1	MMab	TIA-1
Tyrosinase	MMab	BSB-6
Vimentin	MMab	V9
Vimentin	RMab	EP21

Mesothelioma

ANTIBODY	ANTIBODY TYPE	CLONE
BG8 Lewis Y	MMab	F3
Calretinin	RMab	EP1798
* Caveolin 1	RMab	EP353
CEA	MMab	BSB-13
CEA	RPab	Polyclonal
Cytokeratin 5	RMab	EP24
Cytokeratin 5 & 6	RMab	D5/16B4
Cytokeratin 5 & 6	RMab	EP24 & EP67
Cytokeratin 7	MMab	OV-TL 12/30

QUICK GUIDE REFERENCE

* NEW ANTIBODIES ■ ASR ■ RUO

Mesothelioma

ANTIBODY	ANTIBODY TYPE	CLONE
Cytokeratin 7	RMab	EP16
E-Cadherin	RMab	EP6
EpCAM/Epithelial Specific Antigen	MMab	BerEP4
EPCAM/Epithelial Specific Antigen	MMab	MOC-31
GLUT1	RMab	EP141
* Mesothelial	MMab	HBME-1
Mesothelial	RMab	EP140
Podoplanin/d2-40	MMab	D2-40
TAG-72	MMab	BSB-21
Thrombomodulin/CD141	RMab	EP175
TTF-1	MMab	8G7G3/1

Neural & Neuroendocrine

ANTIBODY	ANTIBODY TYPE	CLONE
ACTH	MMab	BSB-25
* Alpha Synuclein	MMab	BSB-114
* Amyloid Beta	RMab	RBT-A4
* ATRX	MMab	BSB-108
* Brachyury	RPab	Polyclonal
c-MET/HGFR	RMab	EP1454Y
Calcitonin	RPab	N/A
Calcitonin	RMab	EP92
CD56	MMab	123C3.D5
CD57	MMab	BSB-10
Chromogranin A	MMab	LK2H10
Cytokeratin 18	RMab	EP30
FSH	MMab	BSB-55
Gastrin	RPab	N/A
GFAP	RMab	EP13
* GH	MMab	BSB-99
GH	RPab	N/A
GH	RMab	E267
* Glucagon	MMab	BSB-111
Glucagon	RPab	Polyclonal
Glucagon	RMab	EP74
Histone H3 Phospho	RPab	Polyclonal
Histone H3 Phospho	RMab	EP233
INI-1	MMab	25
Insulin	MMab	BSB-42
Insulin	RMab	EP125
* LEF-1	RMab	EP310
LH	MMab	BSB-16
Myelin Basic Protein	RPab	N/A
Myelin Basic Protein	RMab	EP207
NeuN	MMab	A60
Neuroblastoma	RMab	NB84a
Neurofilament	MMab	2F11
Neurofilament	RMab	EP79
NSE	MMab	BSB-94
OLIG2	RMab	EP112
Prolactin	MMab	PRL02
Prolactin	RMab	EP193
PTEN	MMab	6H2.1
PTEN	RMab	RBT-PTEN
* Somatostatin	MMab	BSB-113
Somatostatin	RPab	N/A
Somatostatin	RMab	EP130
Synaptophysin	RPab	Polyclonal
Synaptophysin	RMab	EP158
* Tau	MMab	BSB-115
TSH	MMab	BSB-56

QUICK GUIDE REFERENCE

* NEW ANTIBODIES ■ ASR ■ RUO

PLEASE NOTE: All antibodies are IVD unless otherwise specified.

PLEASE NOTE: All antibodies are IVD unless otherwise specified.

All Antibodies Available

Concentrate and Predilute

All Antibodies Available

Concentrate and Predilute

New Antibodies

ANTIBODY	ANTIBODY TYPE	CLONE
Alpha Synuclein	MMab	BSB-114
Amyloid Beta	RMab	RBT-A4
ATRX	MMab	BSB-108
BAP1	MMab	BSB-109
bcl-6	MMab	BSB-26
Brachyury	RPab	Polyclonal
Caveolin 1	RMab	EP353
CD16	RMab	EP364
CD33	RMab	RBT-CD33
GATA 3	RMab	EP368
GH	MMab	BSB-99
Glucagon	MMab	BSB-111
HE4	RMab	EP370
Herpes Simplex Virus II	MMab	BSB-116
Herpes Simplex Virus I & II	MMab	10A3 / BSB116
Inhibin Alpha	RMab	EP378
LAG-3	RMab	EP294
Langerin/CD2-7	RMab	EP349
LEF-1	RMab	EP310
Mesothelial	MMab	HBME-1
Myoglobin	MMab	BSB-104
Napsin A	MMab	BSB-112
Parvalbumin	RMab	EP300
SMAD4/DPC4	RMab	RBT-SMAD4
Somatostatin	MMab	BSB-113
STAT6	RMab	EP325
Tau	MMab	BSB-115

Ovarian Cancer

ANTIBODY	ANTIBODY TYPE	CLONE
ALDH1A1	RMab	EP168
Bax	RMab	E63
CA-125	MMab	OC125
CA-125	RMab	EP48
Cadherin 17/Li-Cadherin	RMab	EP86
Calretinin	RMab	EP1798
CD30	MMab	Ber-H2
CD99	MMab	BSB-9
CD103/ITGAE	RMab	EP206
CDX2	RMab	EP25
CEA	MMab	BSB-13
CEA	RPab	Polyclonal
Cytokeratin 7	MMab	OV-TL 12/30
Cytokeratin 7	RMab	EP16
Cytokeratin 17	MMab	BSB-33
Cytokeratin 17	RMab	EP98
Cytokeratin 20	MMab	Ks20.8
Cytokeratin 20	RMab	EP23
Cytokeratin 35BH11	MMab	35betaH11
EMA	MMab	E29
ERCC1	RMab	EP219
FOXP1	RMab	EP137
FOXP3	RPab	Polyclonal
FOXP3	RMab	EP340
Glypican-3	MMab	1G12
hCG	MMab	BSB-38
* HE4	RMab	EP370
HLA-DR alpha chain	RMab	EP96
hPL	RMab	EP241

QUICK GUIDE REFERENCE
NEW ANTIBODIES ■ ASR ■ RUO

Ovarian Cancer

ANTIBODY	ANTIBODY TYPE	CLONE
hPL	RPab	Polyclonal
Inhibin Alpha	MMab	R1
* Inhibin Alpha	RMab	EP378
Ki-67	RMab	EP5
MUC4	MMab	8G7
MUC4	RMab	EP256
OCT-4	RMab	EP143
PAX-2	RMab	EP235
PAX-6	RMab	EP341
PAX-8	RMab	EP298
PAX-8	RMab	ZR-1
PD-L1/CD274	RMab	RBT-PDL1
PLAP	MMab	BSB-47
PLAP	RMab	EP194
SALL4	MMab	6E3
SALL4	RMab	EP299
SOX-9	RMab	EP317
Stathmin	RMab	EP247
Survivin	RMab	EP119
WT-1	MMab	6F-H2

Pituitary

ANTIBODY	ANTIBODY TYPE	CLONE
ACTH	MMab	BSB-25
FSH	MMab	BSB-55
* GH	MMab	BSB-99
GH	RPab	N/A
GH	RMab	E267
LH	MMab	BSB-16
Prolactin	MMab	PRL02
Prolactin	RMab	EP193
TSH	MMab	BSB-56
TSH	RMab	EP254

Prostate

ANTIBODY	ANTIBODY TYPE	CLONE
ALDH1A1	RMab	EP168
AMACR/acemase/P504S	RMab	13H4
Androgen Receptor	MMab	BSB-4 (AR-D12)
■ B7H3/CD276	RMab	RBT-B7H3
bcl-2	MMab	BSB-5
bcl-2	RMab	EP36
c-Myc	MMab	9E10
c-Myc	RMab	EP121
CD6	MMab	BSB-54
CD105/Endoglin	RPab	Polyclonal
CD105	RMab	EP274
Cyclin D1	RMab	EP12
Cyclin D1	RMab	RBT14
Cytokeratin 5	RMab	EP24
Cytokeratin 5 & 6	RMab	DS/16B4
Cytokeratin 5 & 6	RMab	EP24 & EP67
Cytokeratin 5 & ERG	RMab	EP24/EP111
Cytokeratin 5 & 6 & ERG	RMab	EP24/EP67/EP111
Cytokeratin 5 & 14	RMab	EP24/EP61
Cytokeratin HMW 34BE12	MMab	34betaE12
ERG	RMab	EP1111
FOXA1/HNF-3A	RPab	Polyclonal

All Antibodies Available
Concentrate and Predilute

PLEASE NOTE: All antibodies are IVD unless otherwise specified.

Prostate cont.

ANTIBODY	ANTIBODY TYPE	CLONE
FOXA1/HNF-3A	RMab	EP277
FOXP3	RPab	Polyclonal
FOXP3	RMab	EP340
HSP-27	MMab	G3.1
Maspin	MMab	BSB-92
NKX3.1	RMab	EP356
Osteonectin/SPARC	MMab	BSB-93
P40	RMab	ZR8
P63	RMab	EP174
PDX1	RMab	EP139
Prostein/P501S	RMab	ZR-9
PSA	MMab	BSB-7
PSA	RMab	RBT-PSA
PSAP	MMab	PASE/4LJ
PSAP	RMab	EP53
PSMA	RMab	EP192
PSP94/MSMB	RMab	EP203
PTEN	MMab	6H2.1
PTEN	RMab	RBT-PTEN
S100P	RMab	EP186
SOX-9	RMab	EP317
Survivin	RMab	EP119

Rejection & Autoimmunity

ANTIBODY	ANTIBODY TYPE	CLONE
Cytokeratin 16	RMab	EP297
Desmoglein-3	MMab	BSB-61
Desmoglein-3	RMab	EP306
Granzyme B	RPab	Polyclonal
Granzyme B	RMab	EP230
IgD	RMab	EP173
IgG	MMab	BSB-40
IgM	MMab	BSB-41
iNOS	RMab	RBT-iNOS
Kappa Light Chains	MMab	BSB-58
* LAG-3	RMab	EP294
Lambda	MMab	BSB-16
■ OX40/CD134	MMab	BSB-90
Perforin	MMab	5B10
S100A9	RMab	EP185

Sarcoma & Soft Tissue

ANTIBODY	ANTIBODY TYPE	CLONE
Actin, Muscle Specific	MMab	HHF35
Actin, Smooth Muscle	MMab	BSB-15
ALDH1A1	RMab	EP168
Caldesmon	MMab	BSB-19
Calponin	MMab	BSB-20
CA15-3	RMab	DF3
CD13	MMab	38C12
CD13	RMab	EP117
CD14	MMab	7
CD14	RMab	EP128
* CD33	RMab	RBT-CD33
CD34	MMab	QBEnd/10
CD34	RMab	EP88
CD35	MMab	RLB25
CD35	RMab	EP197

QUICK GUIDE REFERENCE
NEW ANTIBODIES ■ ASR ■ RUO

PLEASE NOTE: All antibodies are IVD unless otherwise specified.

Sarcoma & Soft Tissue

ANTIBODY	ANTIBODY TYPE	CLONE
CD99	MMab	BSB-9
CD117	RMab	EP10
CD163	MMab	10D6
CD163	RMab	EP324
CDK4	RMab	EP180
Cytokeratin 5 & ERG	RMab	EP24/EP111
Cytokeratin Cocktail AE1&AE3	MMab	AE1/AE3
Cytokeratin OSCAR	MMab	OSCAR
Desmin	MMab	D33
Desmin	RMab	EP15
DOG1	RMab	EP332
DOG1	RMab	RBT-DOG1
Factor VIII-Related Antigen	RPab	N/A
Fli-1	MMab	G146-222
FOXO1	RMab	EP290
■ HHV-8	MMab	13B10
Histone H3 Phospho	RPab	Polyclonal
Histone H3 Phospho	RMab	EP233
* Langerin/CD2-7	RMab	EP349
MDM2	MMab	BSB-64
Melanoma/PNL2	MMab	PNL2
MUC4	MMab	8G7
MUC4	RMab	EP256
MyoD1	RMab	EP212
Myogenin	MMab	F5D
Myogenin	RMab	EP162
Myoglobin	MMab	BSB-104
Myoglobin	RPab	N/A
Myoglobin	RMab	EP87
NKX2.2	RMab	EP336
PDGFR-B	RMab	RBT-PDGFRB
Podoplanin/d2-40	MMab	D2-40
* STAT6	RMab	EP325
STAT6	RPab	Polyclonal

Thyroid & Parathyroid

ANTIBODY	ANTIBODY TYPE	CLONE
■ BRAF V600E	RMab	RM8
Cadherin-6	RMab	EP217
Calcitonin	RPab	N/A
Calcitonin	RMab	EP92
CD117	RMab	EP10
Cytokeratin 19	MMab	BSB-34
Cytokeratin 19	RMab	EP72
Galectin-3	MMab	9C4
IgG4	MMab	BSB-96
IgG4	RMab	EP138
P63	RMab	EP174
Parafibromin	MMab	BSB-50
Parathyroid Hormone/PTH	MMab	BSB-24
PAX-8	RMab	EP298
PAX-8	RMab	ZR-1
S100A6	RMab	EP313
Synaptophysin	RPab	Polyclonal
Synaptophysin	RMab	EP158
Thyroglobulin	MMab	BSB-49
Thyroglobulin	MMab	2H11/6E1
Thyroglobulin	RMab	EP250
Thyroid Peroxidase	RMab	EP159
TTF-1	MMab	8G7G3/1

All Antibodies Available
Concentrate and Predilute

Undifferentiated		
ANTIBODY	ANTIBODY TYPE	CLONE
Actin, Muscle Specific	MMab	HHF35
Alpha-Fetaprotein	MMab	BSB-23
Alpha-Fetaprotein	RMab	EP209
CD34	MMab	QBEnd/10
CD34	RMab	EP88
CD45	MMab	2B11 & PD7/26
CD56	MMab	123C3.D5
CD99	MMab	BSB-9
CD117	RMab	EPI0
Cytokeratin Cocktail AE1&AE3	MMab	AE1/AE3
Cytokeratin HMW/AE3	MMab	AE3
Cytokeratin LMW/AE1	MMab	AE1
Cytokeratin OSCAR	MMab	OSCAR
Desmin	MMab	D33
Desmin	RMab	EP15
Galectin-3	MMab	9C4

Undifferentiated		
ANTIBODY	ANTIBODY TYPE	CLONE
hCG	MMab	BSB-38
Melanoma/PNL2	MMab	PNL2
Myogenin	MMab	F5D
Myogenin	RMab	EP162
OCT-4	RMab	EP143
p57	MMab	KP10
PLAP	MMab	BSB-47
PLAP	RMab	EP194
S100	MMab	4C4.9
SALL4	MMab	6E3
SALL4	RMab	EP299
SOX-2	RMab	EP103
Synaptophysin	RPab	Polyclonal
Synaptophysin	RMab	EP158
Vimentin	MMab	V9
Vimentin	RMab	EP21

Immunohistochemistry

Immunohistochemistry or Immunocytochemistry is the name of the method for localizing specific antigens in tissue or cells using antibodies, enzyme conjugates and substrate-chromogens. The antigen-antibody reaction can be evidenced with an optical microscope. The antibodies can be polyclonal or monoclonal (usually from mouse or rabbit) in origin. These non-infectious biological reagents are used by research and clinical laboratories to detect the presence of infectious agents, cancer and other proteins of interest. Cancer Diagnostics, Inc. offers a wide range of rabbit and mouse monoclonal and polyclonal antibodies for IVD and ASR applications as well as complete detection systems or their components. We offer both HRP and AP kits: The ImmunoDetector kits use the traditional 3-step Biotin-Streptavidin-Enzyme / Substrate-Chromogen technology while the PolyDetector and CytoDetector kits have been developed using a proprietary tandem hyperlabelling technology used to directly label immunoglobulins with enzymes. This ensures consistent and reproducible immunostaining for all types of nuclear, cytoplasmic and membranal antigens, in different types of tissues or cells. We also offer for RUO, Complete CytoDetector HRP/DAB kits for HPV and Complete PolyDetector HRP/DAB kits for ER/PR, HER-2 neu and CD117 that include all reagents, solutions, tissue controls and reagent controls.



Tris Buffered Saline Concentrate, 20X

When diluted to 1X with water, it makes 25 mM Tris, pH 7.4.

Item	Description	Qty
TBS20X	W/O Tween, Liter (1000 mL)	EA.
TBST20X	With Tween, Liter (1000 mL)	EA.

Phosphate Buffered Saline, 10X

Phosphate buffered saline (abbreviated PBS) is a buffer used in some biochemical techniques to maintain the pH within a relatively narrow range. It has a slightly alkaline buffering capacity in the 7.4 range. TBS has many uses because it is isotonic and non-toxic. It can be used to dilute substances. Additives can be used to add function. TBS is often used in immuno-blotting for both membrane washing and antibody dilution.

Item	Description	Qty
SSC1180-1000	Liter (1000 mL)	EA.



Refer to our website or request our IHC catalog for more IHC information



Tissue Capture Pen

For better adherence of tissue sections. Apply tip to slide in one motion. Slide is ready to use. Pen "charges" approximately 3500 slides.

Item	Qty
TC0417	EA.



Super Pap Pen

The surface tension provided by the circle drawn with the pen ensures that only the amount of antibody solution needed for sufficient reaction will be applied. Stable up to 129 degrees C in microwave heat.

The Pap Pen is very effective for immunostaining procedures by the Peroxidase-Antiperoxidase (PAP) method, ABC method, B-SA method, immunofluorescence method, ASD method, Enzyme method and Frozen Section method.

Regular Tip

Item	Qty
SPR0905	EA.

Mini Tip

Item	Qty
SPM0928	EA.

Detection Systems

Micro-polymer for High Sensitivity



Immunohistochemistry (IHC) is a method for detecting antigens in cells of a tissue section by exploiting the principle of antibodies binding specifically to antigens in biological tissues. The antibody-antigen binding can be visualized in different manners. Enzymes, such as **Horseradish Peroxidase (HRP)** or **Alkaline Phosphatase (AP)**, are commonly used to catalyze a color-producing reaction.

ImmunoDetector HRP Detection System

For the Immunohistochemical detection of antigens in cells and formalin-fixed or frozen tissues

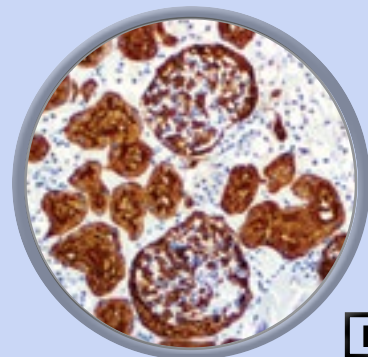

IHC of CD10 on an FFPE Kidney Tissue

IVD

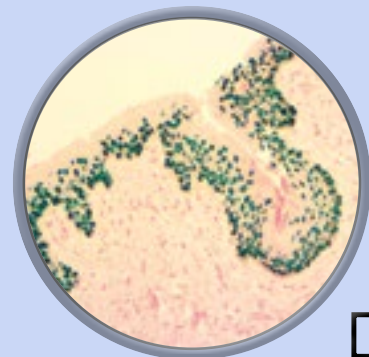

IHC of p63 on an FFPE Skin Tissue

IVD

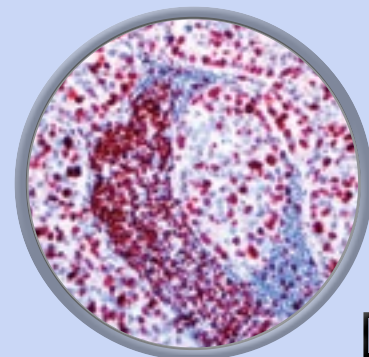

IHC of Ki67 on an FFPE Breast Carcinoma Tissue

IVD

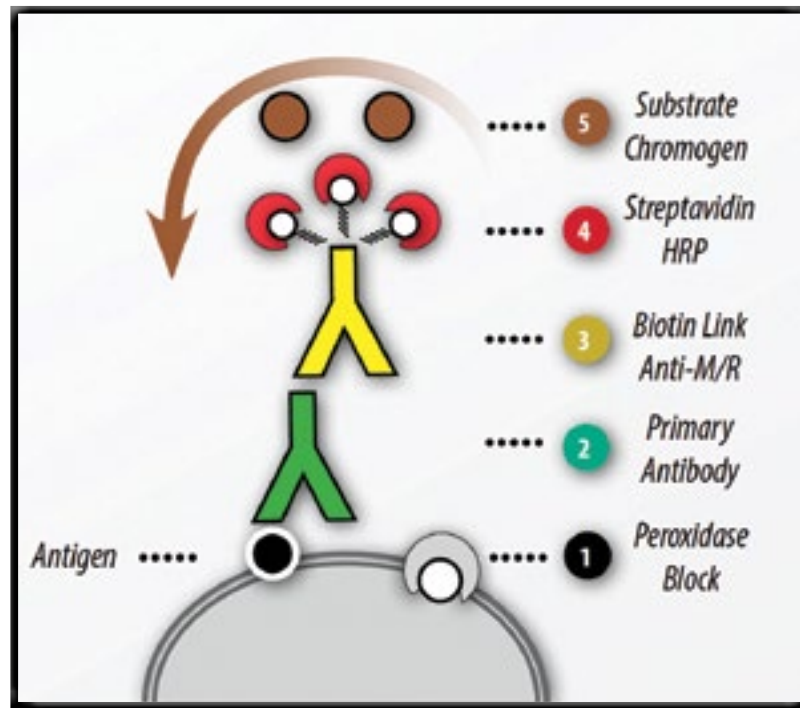

The Mouse/Rabbit ImmunoDetector HRP/AEC Detection System is a Biotin-Streptavidin-Horseradish Peroxidase Detection System that allows for the demonstration of antigens in paraffin-embedded tissue, cryostat sections, cytosmears, and cell preparations. The increased sensitivity of the Mouse/Rabbit ImmunoDetector HRP/AEC Detection System allows for rapid staining procedures without compromises in the quality of stains.

- Biotin-streptavidin immunohistochemistry detection technology.
- Universal ready-to-use formulation detects mouse or rabbit antibodies.
- Optimized for use with Bio SB Tinto Prediluted antibodies.
- Kits available in mouse/rabbit configurations.
- All kits manufactured according to US FDA and ISO 13485 Guidelines.

CAT. #	PRESENTATION	VOL
ImmunoDetector HRP Link & label		
BSB 0001LH	Mouse/Rabbit ImmunoDetector Biotin	15.0 ml
BSB 0003LH	Mouse/Rabbit ImmunoDetector Biotin	50.0 ml
BSB 0005LH	Mouse/Rabbit ImmunoDetector Biotin	100.0 ml
BSB 0007LH	Mouse/Rabbit ImmunoDetector Biotin	200.0 ml
BSB 0009LH	Mouse/Rabbit ImmunoDetector Biotin	1000.0 ml
ImmunoDetector HRP Label		
BSB 0001H	Mouse/Rabbit ImmunoDetector HRP Label	15.0 ml
BSB 0003H	Mouse/Rabbit ImmunoDetector HRP Label	50.0 ml
BSB 0005H	Mouse/Rabbit ImmunoDetector HRP Label	100.0 ml
BSB 0007H	Mouse/Rabbit ImmunoDetector HRP Label	200.0 ml
BSB 0009H	Mouse/Rabbit ImmunoDetector HRP Label	1000.0 ml

IVD For in Vitro Diagnostic Use

10 tests per ml considering 100µl per tissue

ImmunoDetector AP with ALK Magenta Detection System

For the Immunohistochemical detection of antigens in cells and formalin-fixed or frozen tissues

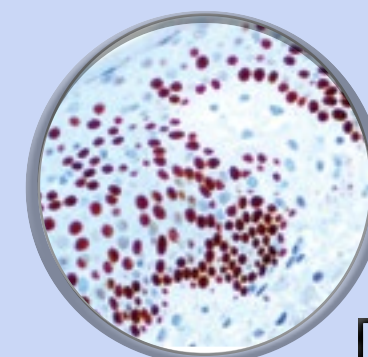

IHC of p63 on an FFPE Skin Tissue

IVD

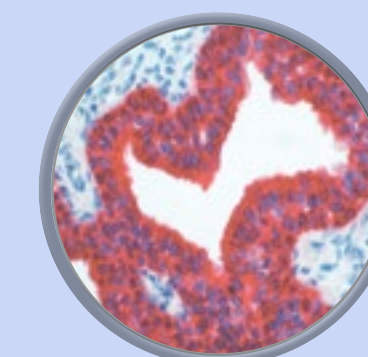

IHC of Cytokeratin Pan Cocktail AE1 & AE3 on an FFPE Prostate Carcinoma

IVD

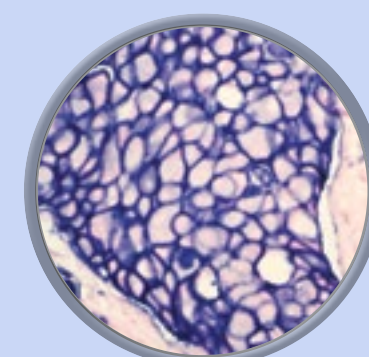

IHC of HER-2 neu on an FFPE Breast Carcinoma

IVD

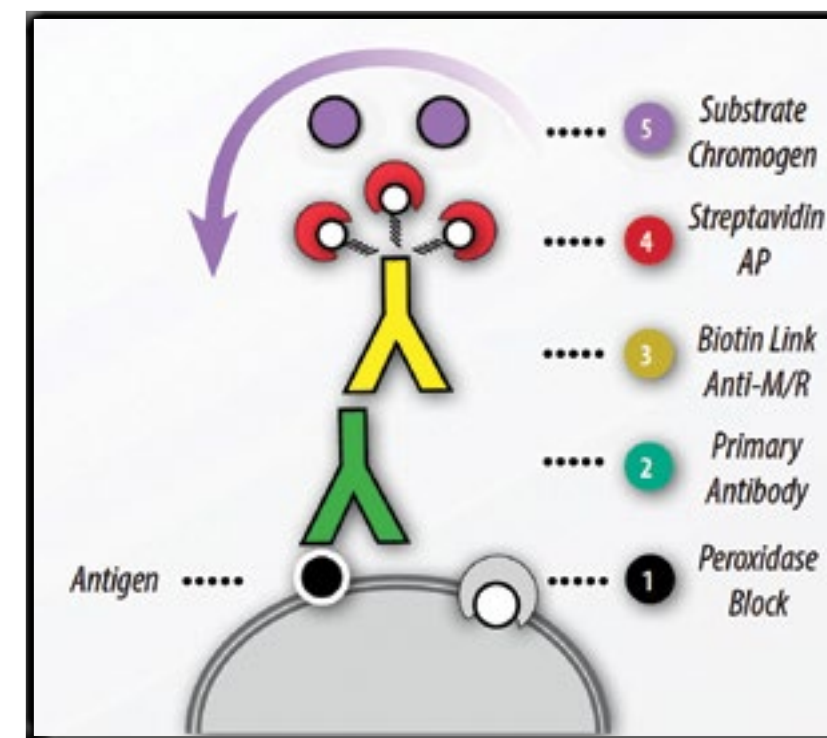

The Mouse/Rabbit ImmunoDetector Alkaline Phosphatase ALK Magenta Detection System is a Biotin-Streptavidin-Alkaline Phosphatase Detection System that allows for the demonstration of antigens in paraffin-embedded tissue, cryostat sections, cytosmears, and cell preparations. The increased sensitivity of ImmunoDetector AP/ALK Magenta Detection System allows for rapid staining procedures without compromises in the quality of stains.

- Biotin-streptavidin 2-step immunohistochemistry detection technology.
- Universal ready-to-use formulation detects mouse or rabbit antibodies.
- Optimized for use with Bio SB Prediluted antibodies.
- Kits available in mouse/rabbit configurations.
- All kits manufactured according to US FDA and ISO 13485 Guidelines.

CAT. #	PRESENTATION	VOL
ImmunoDetector AP Detection Systems		
BSB 0082	Mouse/Rabbit ImmunoDetector AP, w/ALK Magenta	15.0 ml
BSB 0083	Mouse/Rabbit ImmunoDetector AP, w/ALK Magenta	50.0 ml
BSB 0084	Mouse/Rabbit ImmunoDetector AP, w/ALK Magenta	100.0 ml
BSB 0085	Mouse/Rabbit ImmunoDetector AP, w/ALK Magenta	200.0 ml
BSB 0086	Mouse/Rabbit ImmunoDetector AP, w/ALK Magenta	1000.0 ml

IVD For in Vitro Diagnostic Use

10 tests per ml considering 100µl per tissue

PolyDetector HRP Detection System

For the Immunohistochemical detection of antigens in cells and formalin-fixed or frozen tissues

PolyDetector AP Detection System

For the Immunohistochemical detection of antigens in cells and formalin-fixed or frozen tissues

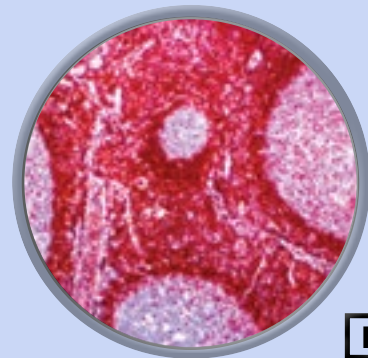

IHC of bcl2 on an FFPE Tonsil Tissue

IVD

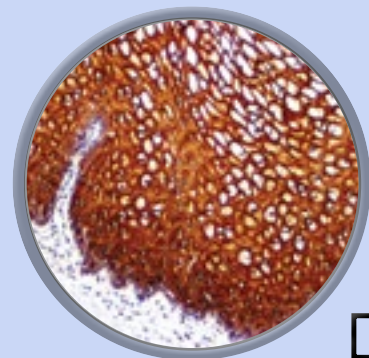

IHC of Cytokeratin 13 on an FFPE Cervix Tissue

IVD

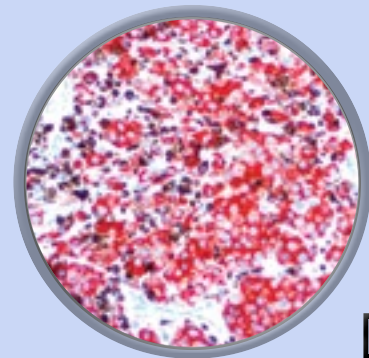

IHC of S100 on an FFPE Melanoma Tissue

IVD

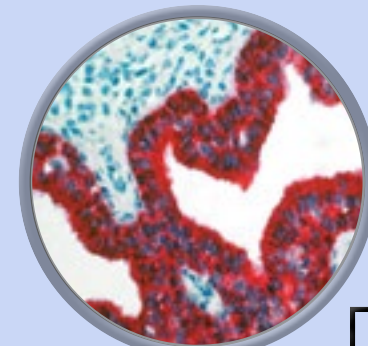

IHC of CK 8/35BH11 on an FFPE Prostate Tissue

IVD

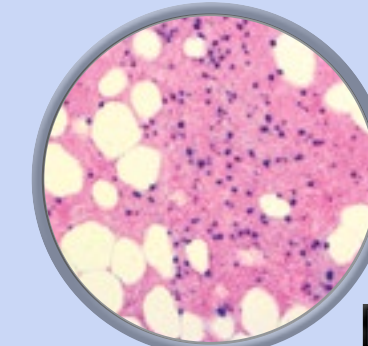

IHC of FOXP3 on an FFPE Chronic Lymphocytic Leukemia

IVD

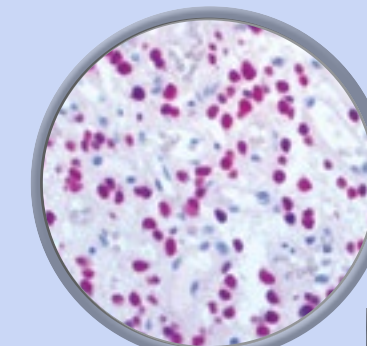

IHC of SOX-2 on an FFPE Brain Tissue

IVD

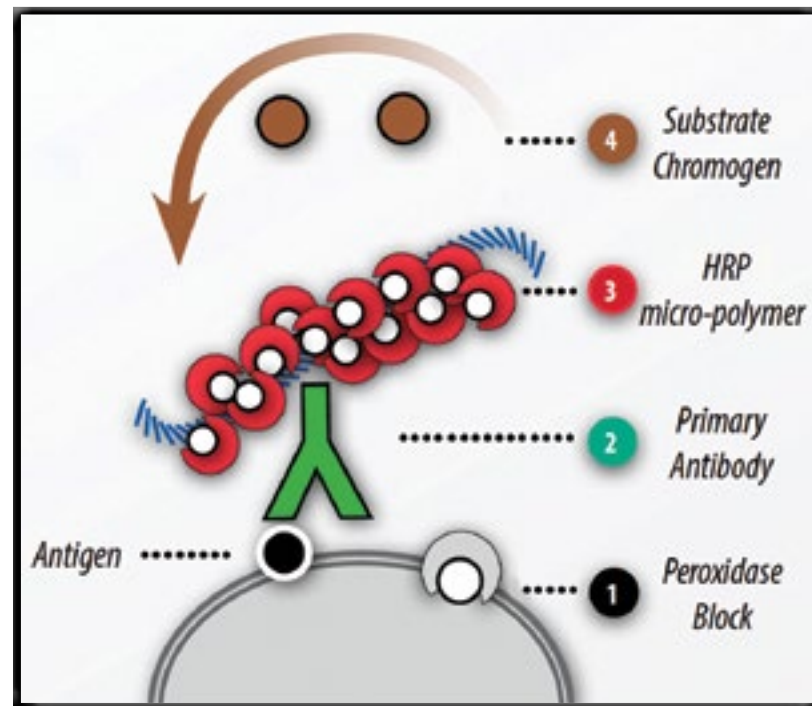

The Mouse/Rabbit PolyDetector HRP/AEC System is a non-biotin, 2-step polymeric detection system that allows for the demonstration of antigens in paraffin-embedded tissue, cryostat sections, blood smears, cytosmears, and cell preparations. The PolyDetector kits have been developed using a proprietary tandem hyperlabelling technology used to directly label immunoglobulins with enzymes. This ensures consistent and reproducible immunostaining for all types of nuclear, cytoplasmic and membranal antigens, in different types of tissues.

- Non-Biotin, Fab micro-polymer detection technology allows for better cell penetration to deliver a highly specific and sensitive signal.
- Universal Ready-to-use formulation detects mouse or rabbit antibodies.
- AP and HRP Systems can be used in multiplex IHC staining.
- Optimized for use with Bio SB Tinto Prediluted antibodies.
- Kits available in mouse/rabbit configurations.
- All kits manufactured according to US FDA and ISO 13485 Guidelines.

CAT. #	PRESENTATION	VOL
Complete PolyDetector HRP Detection Systems		
BSB 0201	Mouse/Rabbit PolyDetector HRP w/DAB	15.0 ml
BSB 0202	Mouse/Rabbit PolyDetector HRP w/AEC	15.0 ml
BSB 0203	Mouse/Rabbit PolyDetector HRP w/DAB	50.0 ml
BSB 0204	Mouse/Rabbit PolyDetector HRP w/AEC	50.0 ml
BSB 0205	Mouse/Rabbit PolyDetector HRP w/DAB	100.0 ml
BSB 0206	Mouse/Rabbit PolyDetector HRP w/AEC	100.0 ml
BSB 0207	Mouse/Rabbit PolyDetector HRP w/DAB	200.0 ml
BSB 0208	Mouse/Rabbit PolyDetector HRP w/AEC	200.0 ml
BSB 0207A	Mouse/Rabbit PolyDetector HRP w/DAB	1000.0 ml
BSB 0208A	Mouse/Rabbit PolyDetector HRP w/AEC	1000.0 ml

CAT. #	PRESENTATION	VOL
PolyDetector HRP Label – Prediluted		
BSB 0201H	Mouse/Rabbit PolyDetector HRP Label	15.0 ml
BSB 0203H	Mouse/Rabbit PolyDetector HRP Label	50.0 ml
BSB 0205H	Mouse/Rabbit PolyDetector HRP Label	100.0 ml
BSB 0207H	Mouse/Rabbit PolyDetector HRP Label	200.0 ml

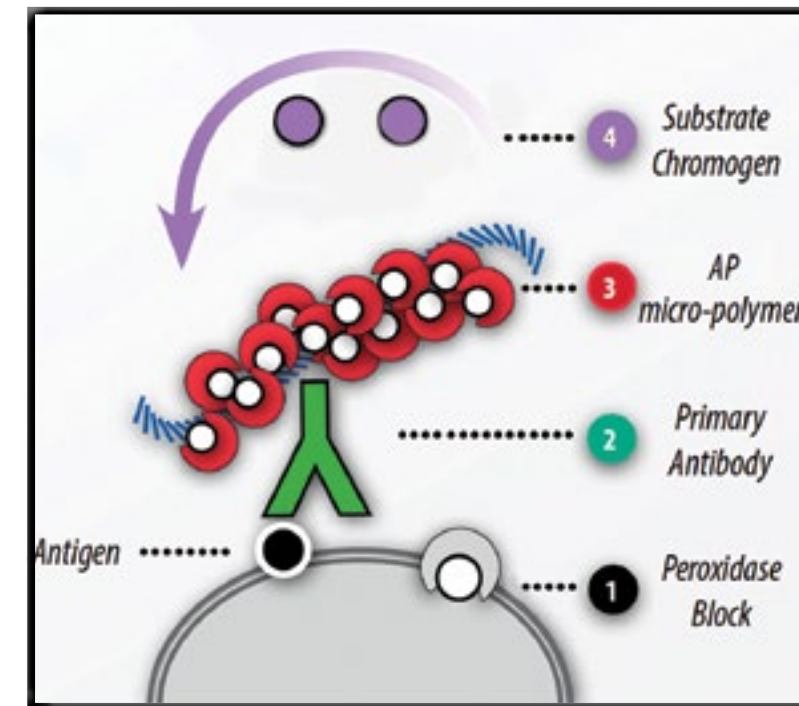

The Mouse/Rabbit PolyDetector Alkaline Phosphatase/ ALK Magenta System is a non-biotin, 2-step polymeric detection system that allows for the demonstration of antigens in paraffin-embedded tissue, cryostat sections, blood smears, cytosmears, and cell preparations. The PolyDetector kits have been developed using a proprietary tandem hyperlabelling technology used to directly label immunoglobulins with enzymes. This ensures consistent and reproducible immunostaining for all types of nuclear, cytoplasmic and membranal antigens, in different types of tissues.

- Non-Biotin, Fab micro-polymer detection technology allows for better cell penetration to deliver a highly specific and sensitive signal.
- Universal Ready-to-use formulation detects mouse or rabbit antibodies.
- AP and HRP Systems can be used in multiplex IHC staining.
- Optimized for use with Bio SB Tinto Prediluted antibodies.
- Kits available in mouse/rabbit configurations.
- All kits manufactured according to US FDA and ISO 13485 Guidelines.

CAT. #	PRESENTATION	VOL
Complete PolyDetector AP Detection Systems		
BSB 0282	Mouse/Rabbit PolyDetector AP w/ALK Magenta	15.0 ml
BSB 0283	Mouse/Rabbit PolyDetector AP w/ALK Magenta	50.0 ml
BSB 0284	Mouse/Rabbit PolyDetector AP w/ALK Magenta	100.0 ml
BSB 0285	Mouse/Rabbit PolyDetector AP w/ALK Magenta	200.0 ml
BSB 0286	Mouse/Rabbit PolyDetector AP w/ALK Magenta	1000.0 ml
PolyDetector AP Label - Prediluted		
BSB 0287	Mouse/Rabbit PolyDetector AP Label	15.0 ml
BSB 0288	Mouse/Rabbit PolyDetector AP Label	50.0 ml
BSB 0289	Mouse/Rabbit PolyDetector AP Label	100.0 ml
BSB 0290	Mouse/Rabbit PolyDetector AP Label	200.0 ml
BSB 0291	Mouse/Rabbit PolyDetector AP Label	1000.0 ml

IVD For in Vitro Diagnostic Use

10 tests per ml considering 100µl per tissue

IVD For in Vitro Diagnostic Use

10 tests per ml considering 100µl per tissue

PolyDetector Plus HRP Detection System

For the Immunohistochemical detection of antigens in cells and formalin-fixed or frozen tissues

HER-2 neu PolyDetector HRP/DAB Detection System

For the Immunohistochemical detection of HER-2 neu in formalin-fixed paraffin-embedded tissues

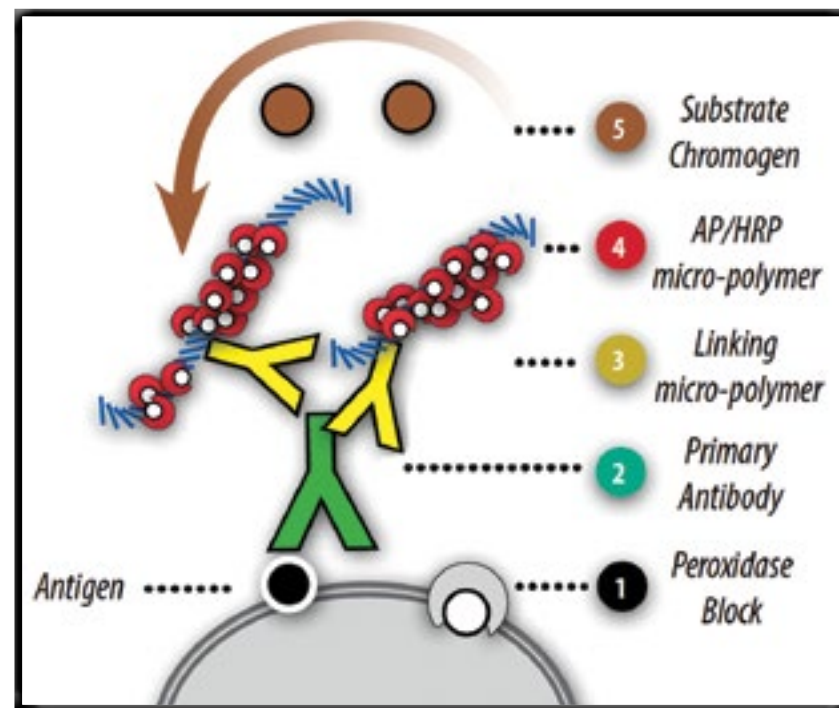
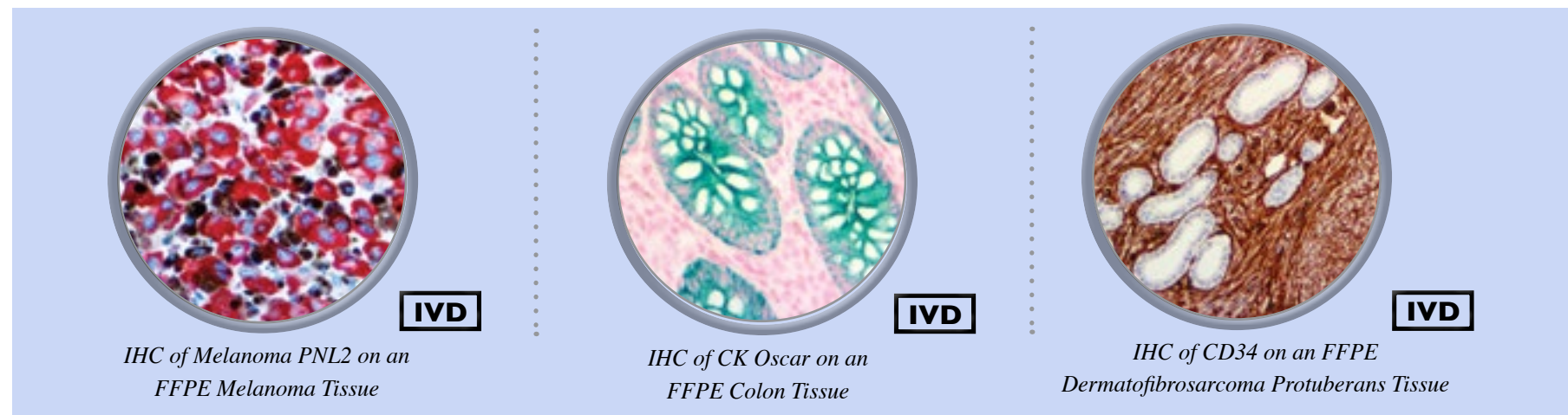

The Mouse/Rabbit PolyDetector Plus HRP AEC System is a non-biotin, 3-step polymeric detection system that allows for the demonstration of antigens in paraffin-embedded tissue, cryostat sections, blood smears, cytospins, and cell preparations. The PolyDetector PLUS kits ensure consistent and reproducible immunostaining for all types of nuclear, cytoplasmic and membranal antigens, in different types of tissues.

- Non-Biotin, Fab micro-polymer detection technology allows for better cell penetration to deliver a highly specific and sensitive signal.
- Universal Ready-to-use formulation detects mouse or rabbit antibodies.
- Short incubation times for each polymer.
- Optimized for use with Bio SB Tinto Prediluted antibodies.
- Kits available in mouse/rabbit configurations.
- All kits manufactured according to US FDA and ISO 13485 Guidelines.

CAT. #	PRESENTATION	VOL
PolyDetector PLUS Link & HRP Label – Prediluted		
BSB 0267	Mouse/Rabbit PolyDetector Plus Link & HRP Label	15.0 ml
BSB 0268	Mouse/Rabbit PolyDetector Plus Link & HRP Label	50.0 ml
BSB 0269	Mouse/Rabbit PolyDetector Plus Link & HRP Label	100.0 ml
BSB 0270	Mouse/Rabbit PolyDetector Plus Link & HRP Label	200.0 ml
BSB 0271	Mouse/Rabbit PolyDetector Plus Link & HRP Label	1000.0 ml
BSB 0272	Mouse/Rabbit PolyDetector Plus Link	15.0 ml
BSB 0273	Mouse/Rabbit PolyDetector Plus Link	50.0 ml
BSB 0274	Mouse/Rabbit PolyDetector Plus Link	100.0 ml
BSB 0275	Mouse/Rabbit PolyDetector Plus Link	200.0 ml
BSB 0276	Mouse/Rabbit PolyDetector Plus Link	1000.0 ml
BSB 0277	Mouse/Rabbit PolyDetector Plus HRP Label	15.0 ml
BSB 0278	Mouse/Rabbit PolyDetector Plus HRP Label	50.0 ml
BSB 0279	Mouse/Rabbit PolyDetector Plus HRP Label	100.0 ml
BSB 0280	Mouse/Rabbit PolyDetector Plus HRP Label	200.0 ml
BSB 0281	Mouse/Rabbit PolyDetector Plus HRP Label	1000.0 ml

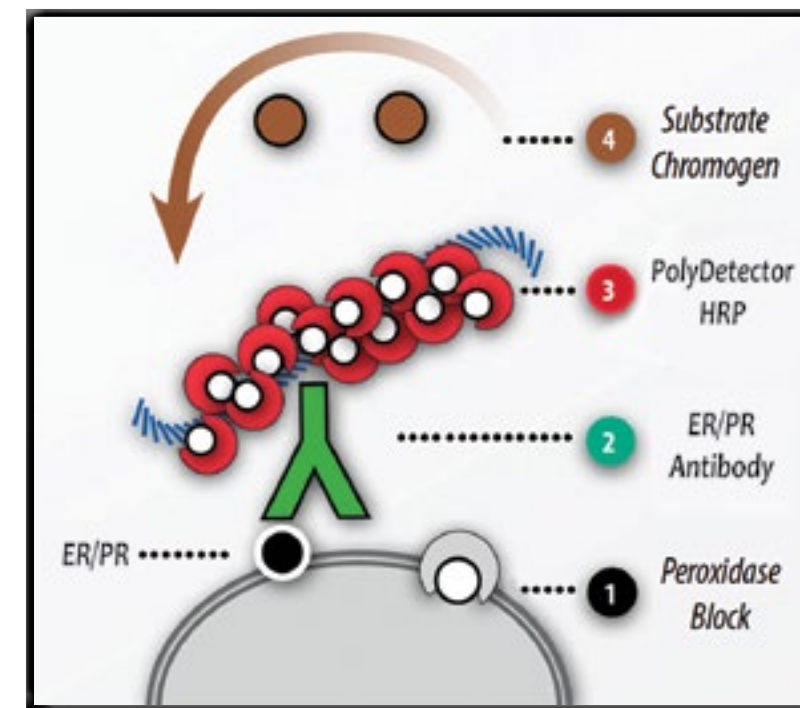

- Semi-quantitative IHC test for the evaluation of HER2-neu overexpression in FFPE breast cancer tissues
- Non-Biotin, 2-Step Immunohistochemistry Detection Technology developed with Proprietary Tandem Hyperlabeling Technology used to directly labeled Immunoglobulins with enzymes
- Kits include all reagents, solutions, tissues and reagent controls
- For maximum reliability, all kits include Tissue Microarray control slides of FFPE cell lines that are negative, 1+, 2+ and 3+ signals
- For Research Use Only

CAT. #	PRESENTATION	QTY
Complete Detection Systems for IHC		
BSB 0245	HER-2 neu PolyDetector HRP/DAB	70 tests
BSB 0246	HER-2 neu PolyDetector HRP/DAB	150 tests
BSB 0247	HER-2 neu PolyDetector HRP/DAB	500 tests

CAT. #	PRESENTATION	VOL
Complete PolyDetector PLUS HRP Detection Systems		
BSB 0257	Mouse/Rabbit PolyDetector Plus HRP w/DAB	15.0 ml
BSB 0258	Mouse/Rabbit PolyDetector Plus HRP w/AEC	15.0 ml
BSB 0259	Mouse/Rabbit PolyDetector Plus HRP w/DAB	50.0 ml
BSB 0260	Mouse/Rabbit PolyDetector Plus HRP w/AEC	50.0 ml
BSB 0261	Mouse/Rabbit PolyDetector Plus HRP w/DAB	100.0 ml
BSB 0262	Mouse/Rabbit PolyDetector Plus HRP w/AEC	100.0 ml
BSB 0263	Mouse/Rabbit PolyDetector Plus HRP w/DAB	200.0 ml
BSB 0264	Mouse/Rabbit PolyDetector Plus HRP w/AEC	200.0 ml
BSB 0265	Mouse/Rabbit PolyDetector Plus HRP w/DAB	1000.0 ml
BSB 0266	Mouse/Rabbit PolyDetector Plus HRP w/AEC	1000.0 ml

ER/PR PolyDetector HRP/DAB Detection System

For the Immunohistochemical detection of Estrogen and Progesterone receptors in formalin-fixed paraffin-embedded tissues

CD117 c-Kit PolyDetector HRP/DAB Detection System

For the Immunohistochemical detection of Estrogen and Progesterone receptors in formalin-fixed paraffin-embedded tissues

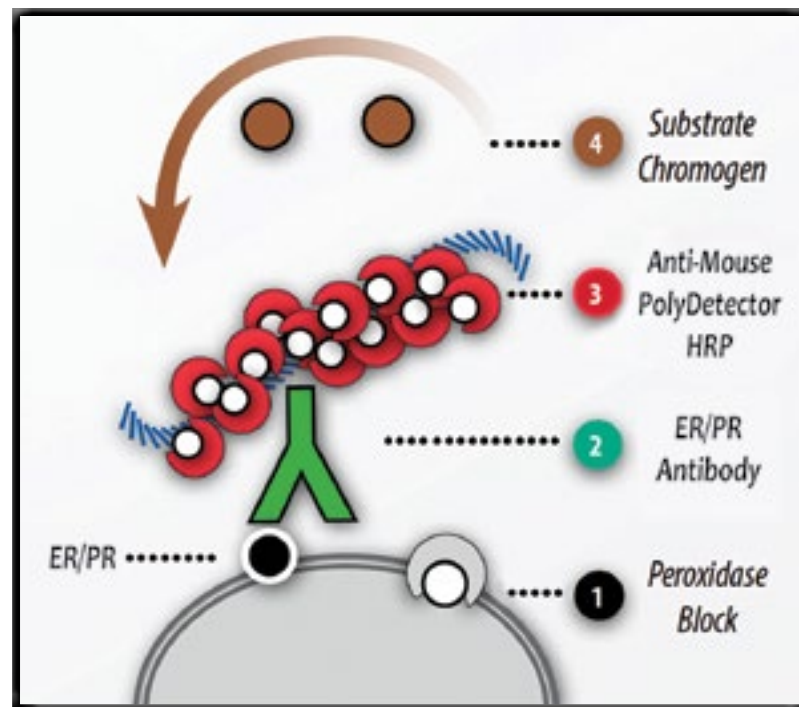
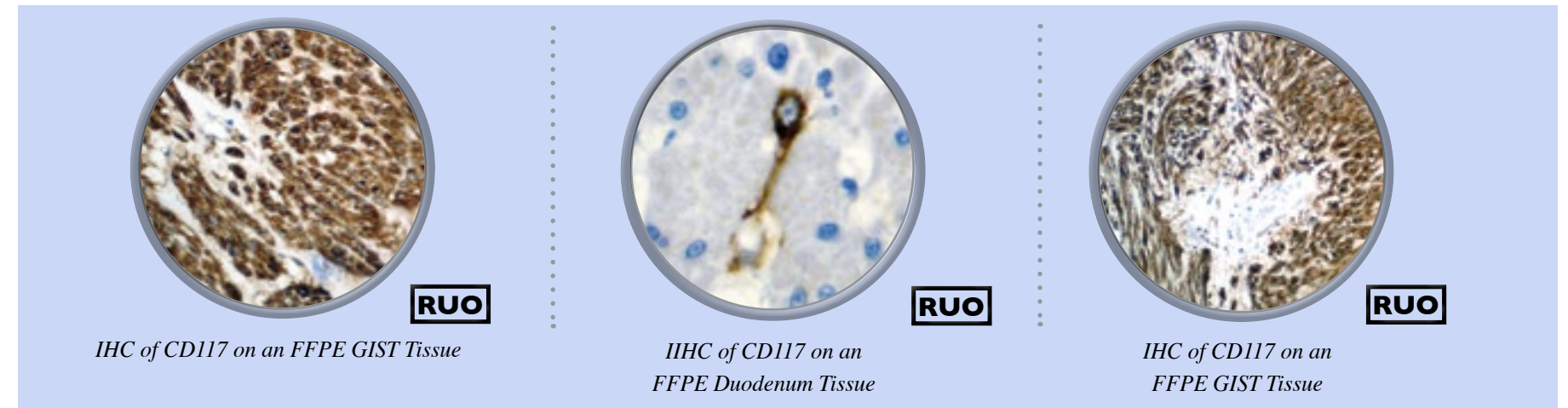

- Immunohistochemical test for the evaluation of ER and PR in FFPE tissues
- Non-Biotin, 2-Step Immunohistochemistry Detection Technology developed with Proprietary Tandem Hyperlabeling Technology used to directly labeled Immunoglobulins with enzymes
- Kits include all reagents, solutions, tissues and reagent controls
- For maximum reliability, all kits include Tissue Microarray control slides of FFPE cell lines that are negative and positive for ER and PR
- For Research Use Only

CAT. #	PRESENTATION	QTY
Complete Detection Systems for IHC		
BSB 0251	ER/PR PolyDetector HRP/DAB	70 tests
BSB 0252	ER/PR PolyDetector HRP/DAB	150 tests
BSB 0253	ER/PR PolyDetector HRP/DAB	500 tests

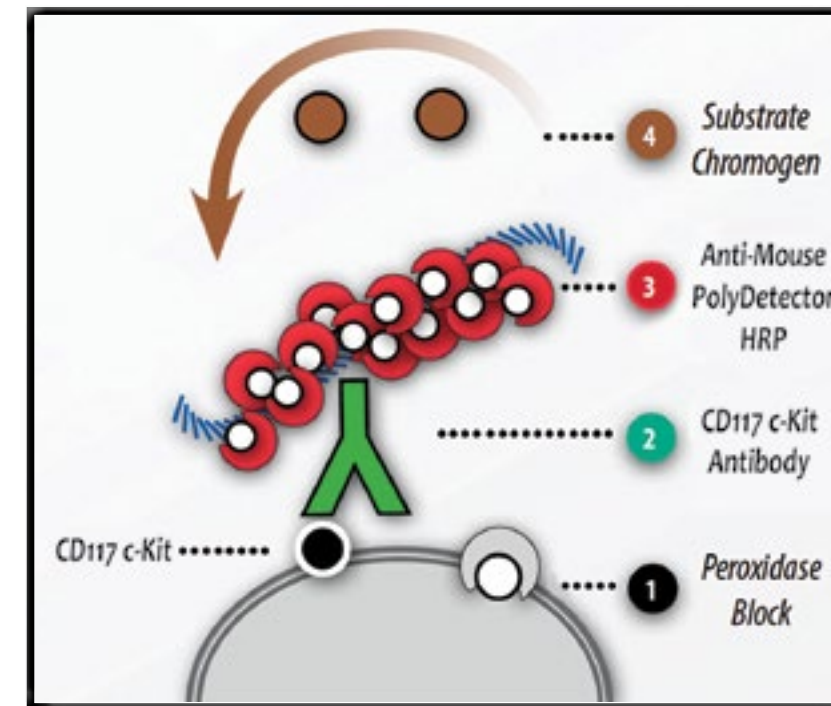

- Immunohistochemical test for the evaluation of CD117 c-Kit in FFPE tissues
- Non-Biotin, 2-Step Immunohistochemistry Detection Technology developed with Proprietary Tandem Hyperlabeling Technology used to directly labeled Immunoglobulins with enzymes
- Kits include all reagents, solutions, tissues and reagent controls
- For maximum reliability, all kits include Tissue Microarray control slides of FFPE tissues that are negative and positive for CD117 c-Kit
- For Research Use Only

CAT. #	PRESENTATION	QTY
Complete Detection Systems for IHC		
BSB 0254	CD117 c-Kit PolyDetector HRP/DAB	60 tests
BSB 0255	CD117 c-Kit PolyDetector HRP/DAB	150 tests
BSB 0256	CD117 c-Kit PolyDetector HRP/DAB	500 tests

Substrate-Chromogen Systems for use with HRP Detection Systems

Substrate-Chromogen Systems for use with AP Detection Systems

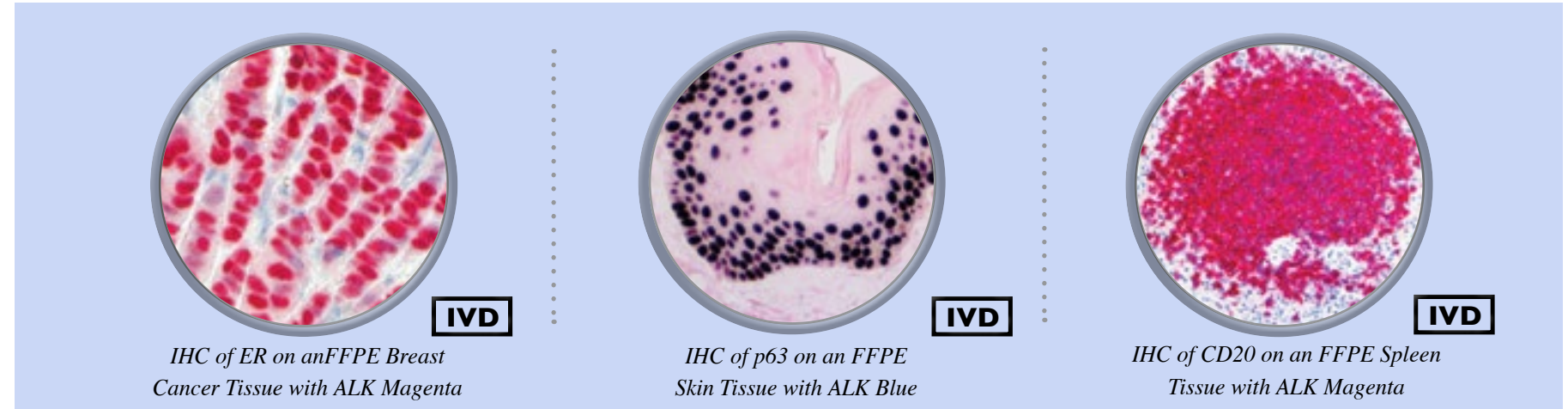
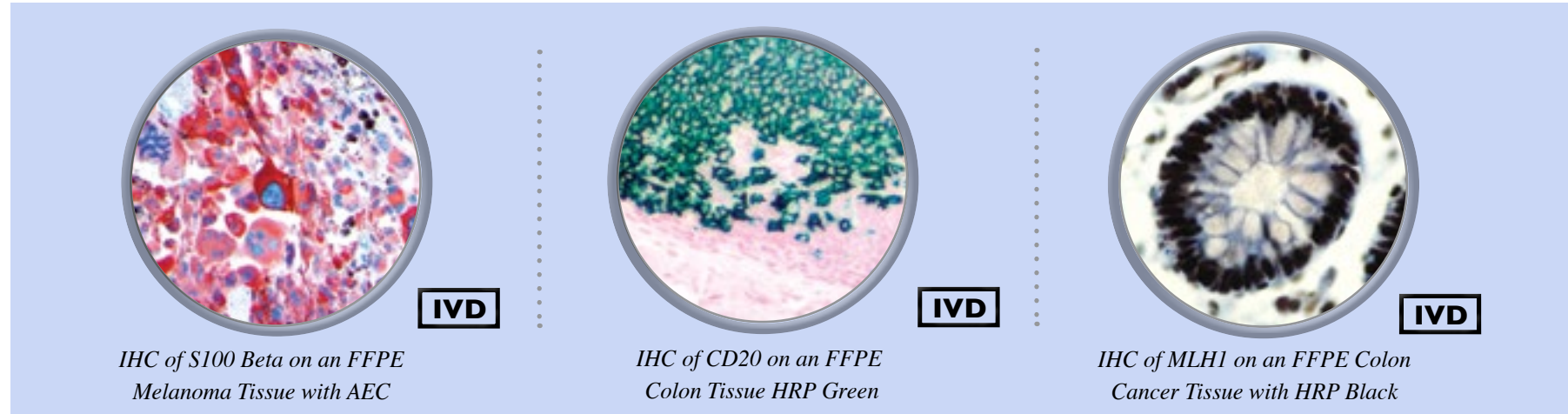

- High Sensitivity
- Low Background
- AEC supplied as Ready-to-Use Format
- Environmentally friendly: No solvents used
- DAB supplied as two components
- HRP Black supplied as three components
- HRP Green supplied as two components
- For *in Vitro* Diagnostic Use

The substrate-chromogen is the final step in the detection portion; it enables the antibody-antigen-enzyme complex to be viewed under the light microscope.

- High Sensitivity
- Low Background
- Environmentally friendly: No solvents used
- Alk Blue, Alk Red and Alk Brown supplied as Ready-to-Use Formats
- ALK Magenta supplied as three components
- For *in Vitro* Diagnostic Use

CAT. #	PRESENTATION	VOL
Substrate-Chromogen Systems for use with HRP Detection Systems		
BSB 0011	ImmunoDetector Liquid AEC Ready-To-Use	15.0 ml
BSB 0012	ImmunoDetector Liquid AEC Ready-To-Use	50.0 ml
BSB 0013	ImmunoDetector Liquid AEC Ready-To-Use	100.0 ml
BSB 0014	ImmunoDetector Liquid AEC Ready-To-Use	200.0 ml
BSB 0061A	ImmunoDetector Liquid AEC Ready-To-use	500.0 ml
BSB 0061	ImmunoDetector Liquid AEC Ready-To-use	1000.0 ml
BSB 0015	ImmunoDetector Liquid DAB kit	15.0 ml
BSB 0016	ImmunoDetector Liquid DAB kit	50.0 ml
BSB 0017	ImmunoDetector Liquid DAB kit	100.0 ml
BSB 0018	ImmunoDetector Liquid DAB kit	200.0 ml
BSB 0018A	ImmunoDetector Liquid DAB kit	500.0 ml
BSB 0018B	ImmunoDetector Liquid DAB kit	1000.0 ml
BSB 0019F	ImmunoDetector DAB Buffer	100.0 ml
BSB 0019E	ImmunoDetector DAB Buffer	200.0 ml
BSB 0019D	ImmunoDetector DAB Buffer	500.0 ml
BSB 0019	ImmunoDetector DAB Buffer	1,000.0 ml
BSB 0019A	ImmunoDetector DAB Chromogen	100.0 ml
BSB 0019B	ImmunoDetector DAB Chromogen	50.0 ml
BSB 0019C	ImmunoDetector DAB Chromogen	12.0 ml
BSB 0019G	ImmunoDetector DAB Chromogen	6.0 ml

CAT. #	PRESENTATION	VOL
Substrate-Chromogen Systems for use with HRP Detection Systems (continued)		
BSB 0087	PolyDetector HRP Black kit	15.0 ml
BSB 0088	PolyDetector HRP Black kit	50.0 ml
BSB 0089	PolyDetector HRP Black kit	100.0 ml
BSB 0090A	PolyDetector HRP Black kit	200.0 ml
BSB 0090B	PolyDetector HRP Black kit	500.0 ml
BSB 0090C	PolyDetector HRP Black kit	1000.0 ml
BSB 0128	PolyDetector HRP Green kit	15.0 ml
BSB 0129	PolyDetector HRP Green kit	50.0 ml
BSB 0130	PolyDetector HRP Green kit	100.0 ml
BSB 0131	PolyDetector HRP Green kit	200.0 ml
BSB 0132	PolyDetector HRP Green kit	500.0 ml
BSB 0133	PolyDetector HRP Green kit	1000.0 ml

CAT. #	PRESENTATION	VOL
Substrate-Chromogen Systems for use with AP Detection Systems		
BSB 0062	PolyDetector Alk Blue Ready-To-Use	15.0 ml
BSB 0063	PolyDetector Alk Blue Ready-To-Use	50.0 ml
BSB 0064	PolyDetector Alk Blue Ready-To-Use	100.0 ml
BSB 0065	PolyDetector Alk Blue Ready-To-Use	200.0 ml
BSB 0066	PolyDetector Alk Blue Ready-To-Use	1000.0 ml
BSB 0067	PolyDetector Alk Red Ready-To-Use	15.0 ml
BSB 0068	PolyDetector Alk Red Ready-To-Use	50.0 ml
BSB 0069	PolyDetector Alk Red Ready-To-Use	100.0 ml
BSB 0070	PolyDetector Alk Red Ready-To-Use	200.0 ml
BSB 0071	PolyDetector Alk Red Ready-To-Use	1000.0 ml

CAT. #	PRESENTATION	VOL
Substrate-Chromogen Systems for use with AP Detection Systems (continued)		
BSB 0072	PolyDetector Alk Brown Ready-To-Use	15.0 ml
BSB 0073	PolyDetector Alk Brown Ready-To-Use	50.0 ml
BSB 0074	PolyDetector Alk Brown Ready-To-Use	100.0 ml
BSB 0075	PolyDetector Alk Brown Ready-To-Use	200.0 ml
BSB 0076	PolyDetector Alk Brown Ready-To-Use	1000.0 ml
BSB 0077	PolyDetector Alk Magenta	15.0 ml
BSB 0078	PolyDetector Alk Magenta	50.0 ml
BSB 0079	PolyDetector Alk Magenta	100.0 ml
BSB 0080	PolyDetector Alk Magenta	200.0 ml
BSB 0081	PolyDetector Alk Magenta	1000.0 ml

Compatibility Guide

The CDI compatibility guide will help ensure that the correct chromogen, counter-stain, and mounting media is used in any test performed.

KEY	
+	= compatible A = Aqua Mounter
-	= incompatible P = Perma Mounter

	DAB	AEC	HRP Black	HRP Green	ALK Magenta	ALK Blue	ALK Brown	ALK Red
Methyl Green	+	-	+	-	+	+/-	-	-
Hematoxylin	+	+	+/-	+/-	+	-	+	+
Nuclear Fast Red	+/-	-	+	+	-	+	+/-	-
Mounting Media	P	A	P	P	A/P	P	A	A

IHC Control Slides

319

IMMUNOHISTOCHEMISTRY

Item Number	Type of Control Slide	Item Number	Type of Control Slide	Item Number	Type of Control Slide	Item Number	Type of Control Slide
BSB 5007	A-1-Antichymotrypsin	BSB 3320	Caveolin-1	BSB 6267	CD105/Endoglin	BSB 5434	Cytokeratin Cocktail AE1&AE3
BSB 5014	A-1-Antitrypsin	BSB 5140	CD1a	BSB 2872	CD105	BSB 5399	Cytokeratin HMW 34BE12
BSB 5021	ACTH	BSB 6211	CD2	BSB 5322	CD117	BSB 2062	Cytokeratin LMW CAM5.2
BSB 5028	Actin Muscle Specific	BSB 6428	CD3	BSB 5329	CD 123	BSB 6183	Cytokeratin OSCAR
BSB 5035	Actin Smooth Muscle	BSB 5154	CD4	BSB 6533	CD138	BSB 5455	Cytomegalovirus
BSB 5042	Adenovirus	BSB 5161	CD5	BSB 3278	CD163	BSB 6715	Desmin
BSB 3252	Adipophilin / ADRP	BSB 2711	CD6	BSB 2642	CDK2	BSB 2900	Desmoglein-3
BSB 2446	AldH1A1	BSB 2851	CD8	BSB 2467	CDK4	BSB 2907	DOG-1
BSB 5049	ALK-1	BSB 5182	CD10	BSB 6063	CDX2	BSB 2481	E2F4
BSB 2802	ALK	BSB 6442	CD11b	BSB 6540	CEA	BSB 2481	E2F4
BSB 3292	Alpha Synuclein	BSB 6449	CD11c	BSB 5350	Chromogranin A	BSB 5469	E-Cadherin
BSB 5056	Alpha-Fetoprotein	BSB 6456	CD13	BSB 6568	Claudin-1	BSB 5476	EGFR
BSB 2390	Alpha-Fetoprotein	BSB 6316	CD14	BSB 2404	Claudin-5	BSB 6722	EGFR Phospho
BSB 5063	AMACRacemase / P504S	BSB 2858	CD15	BSB 6575	Clusterin/ Apolipoprotein J	BSB 5483	EMA
BSB 2809	Amyloid A	BSB 3327	CD16	BSB 6589	c-Met/HGFR	BSB 6729	EpCAM/Epithelial Specific Antigen
BSB 3447	Amyloid Beta	BSB 6470	CD19	BSB 6582	c-Myc	BSB 5490	Epstein Barr Virus LMP-1
BSB 6077	Androgen Receptor	BSB 5196	CD20	BSB 5357	Collagen Type IV	BSB 2488	ERCC1
BSB 6365	Annexin A1	BSB 5203	CD21	BSB 2879	COX-2	BSB 6743	ERG
BSB 2453	Arginase-1	BSB 5210	CD23	BSB 2886	CTLA-4/CD152	BSB 2746	Estrogen Receptor
BSB 3299	ATRX	BSB 2460	CD25	BSB 6554	Cyclin B1	BSB 5504	Factor VIII-Related Antigen
BSB 2816	B7H3/CD276	BSB 5217	CD30	BSB 2474	Cyclin D1	BSB 5511	Factor XIIIa
BSB 3306	BAP1	BSB 5224	CD31	BSB 6561	Cyclin E1	BSB 5518	Fascin
BSB 6084	Bax	BSB 3454	CD33	BSB 6596	Cytokeratin 4	BSB 5525	Fli-1
BSB 5070	BCA-225	BSB 6491	CD34	BSB 6603	Cytokeratin 5	BSB 5532	Follicular Dendritic Cell
BSB 5077	bcl-2	BSB 6498	CD35	BSB 6631	Cytokeratin 5 & 14	BSB 6750	FOXA1 / HNF-3A
BSB 5084	bcl-6	BSB 6505	CD38	BSB 5406	Cytokeratin 5 & 6	BSB 2914	FOXA1
BSB 2704	bcl-10	BSB 6512	CD41/ Integrin alpha IIb	BSB 6617	Cytokeratin 5 & ERG	BSB 2921	FOXO1
BSB 6091	Bcl-x	BSB 5245	CD43	BSB 6624	Cytokeratin 5 & 6 & ERG	BSB 6757	FOXP1
BSB 5091	Beta-Catenin	BSB 6239	CD44	BSB 6645	Cytokeratin 6	BSB 6764	FOXP3
BSB 6379	BG8 LewisY	BSB 5252	CD45	BSB 5413	Cytokeratin 7	BSB 5539	FSH
BSB 6386	BOB.1	BSB 6260	CD45R	BSB 6659	Cytokeratin 7 & CDX2	BSB 5546	Galectin-3
BSB 3313	Brachyury	BSB 5259	CD45RA	BSB 6666	Cytokeratin 8	BSB 5707	Kappa Light Chains
BSB 2830	BRAFV600E	BSB 5266	CD45RO	BSB 2055	Cytokeratin 8&18	BSB 5714	Ki-67
BSB 6393	C3d	BSB 5273	CD56	BSB 6673	Cytokeratin 10	BSB 6288	Ksp-Cadherin
BSB 6400	C4d	BSB 5280	CD57	BSB 6680	Cytokeratin 13	BSB 3369	LAG-3 / CD223
BSB 5098	CA-125	BSB 5287	CD61	BSB 6687	Cytokeratin 14	BSB 5721	Lambda
BSB 5105	CA15-3	BSB 6302	CD63	BSB 6694	Cytokeratin 15	BSB 6848	Langerin
BSB 5112	CA19-9	BSB 2718	CD68	BSB 2893	Cytokeratin 16	BSB 3376	Langerin / CD207
BSB 6855	Cadherin17/L1-Cadherin	BSB 2327	CD7	BSB 6190	Cytokeratin 17	BSB 2935	Glucagon
BSB 2397	Cadherin-6	BSB 6526	CD71	BSB 6701	Cytokeratin 18	BSB 5588	Glutamine Synthetase
BSB 5119	Calcitonin	BSB 5301	CD74	BSB 5385	Cytokeratin 19	BSB 6246	Glycophorin A
BSB 6105	Caldesmon	BSB 2725	CD75	BSB 6708	Cytokeratin 20	BSB 5595	Glypican-3
BSB 5126	Calponin	BSB 5308	CD79a	BSB 5427	Cytokeratin 35BHI1	BSB 5602	Granzyme B
BSB 5133	Calretinin	BSB 5315	CD99	BSB 5441	Cytokeratin LMW AE1	BSB 3355	hCG
BSB 6421	Carbonic Anhydrase 9	BSB 2865	CD103 / ITGAE	BSB 5448	Cytokeratin HMW AE3	BSB 2683	HE4
							Helicobacter Pylori

Item Number	Type of Control Slide	Item Number	Type of Control Slide	Item Number	Type of Control Slide	Item Number	Type of Control Slide
BSB 6792	Hemoglobin A	BSB 6337	MCM2	BSB 5840	p27	BSB 3217	SOX-9
BSB 5616	Hepatitis B Virus Core Antigen	BSB 6890	MCM3	BSB 2076	p40	BSB 2586	SOX10
BSB 5623	Hepatitis B Virus Surface Antigen	BSB 6897	MCM5	BSB 5847	p53	BSB 2222	SOX-11
BSB 5630	Hepatocyte Specific Antigen	BSB 2984	MDM2	BSB 6197	p57	BSB 5944	Spectrin
BSB 5637	HER-2 neu	BSB 2537	MDR-1	BSB 5854-1	p63	BSB 3426	STAT6
BSB 2509	HER2 neu Phospho	BSB 6883	Melanoma Cocktail: HMB-45 Mart-1 & Tyrosinase	BSB 2753	Parafibromin	BSB 2600	Stathmin
BSB 2635	HER-3/c-erbB-3	BSB 6918	Melanoma	BSB 2090	Parathyroid Hormone/PTH	BSB 2229	Survivin
BSB 2690	Herpes Simplex Virus I	BSB 5763	Melanosome	BSB 3412	Parvalbumin	BSB 2236	SV40
BSB 2341	Herpes Simplex Virus II	BSB 3461	Mesothelial Cell	BSB 5860	Parvovirus	BSB 5951	Synaptophysin
BSB 5644	Herpes Simplex Virus I & II	BSB 6925	Mesothelin	BSB 2572	PAX-2	BSB 5958	TAG-72
BSB 2942	hGAL / GCET2	BSB 6253	MiTF	BSB 5867	PAX-5	BSB 3433	Tau
BSB 5651	HHV-8	BSB 5770	MLH1	BSB 3133	PAX-6	BSB 2607	Tinto T-Bet/TBX-2
BSB 2523	HIF-1alpha	BSB 2544	MMP-9	BSB 2104	PAX-8	BSB 2257	TCL1
BSB 6827	Histone H3 Phospho	BSB 5777	MSH2	BSB 3154	PD-1/CD279	BSB 2264	TCR Beta F1
BSB 6799	HLA-DR alpha chain	BSB 6938	MSH6	BSB 2355	PDGFR-B	BSB 5972	TdT
BSB 2439	HLA-DRB1 beta chain	BSB 6155	MUC1	BSB 2655	PD-L1/CD274	BSB 3231	TFE3
BSB 6806	hPL	BSB 6162	MUC2	BSB 3161	PDX1	BSB 2285	Thrombomodulin/ CD141
BSB 5658	HPV	BSB 2991	MUC4	BSB 2111	Perforin	BSB 5979	Thyroglobulin
BSB 2949	HPV16	BSB 6169	MUC5AC	BSB 2118	PGP 9.5	BSB 2621	Thyroid Peroxidase
BSB 2956	HSP-27	BSB 6176	MUC6	BSB 5874	PLAP	BSB 6358	TIA-1
BSB 5665	IgA	BSB 6959	MUM1	BSB 2125	PMS2	BSB 2320	TLE1
BSB 2963	IgD	BSB 2998	Mycobacterium tuberculosis	BSB 5881	Pneumocystis jirovecii	BSB 6344	Topoisomerase IIa
BSB 5679	IgG	BSB 6966	Myelin Basic Protein	BSB 6070	Podoplanin/D2-40	BSB 6049	Toxoplasma gondii
BSB 5679	IgG	BSB 6973	Myeloperoxidase	BSB 5888	Progesterone Receptor	BSB 5986	TRAcP
BSB 6820	IgG4	BSB 5895	Myeloperoxidase	BSB 5895	Prolactin	BSB 3238	Treponema pallidum
BSB 5686	IgM	BSB 3168	MyoD1	BSB 5902	Prostein/P501S	BSB 5993	Trypsin
BSB 2970	IMP-3 / IGF2BP3	BSB 5902	Myogenin	BSB 5909	PSA	BSB 6000	TSH
BSB 3362	Inhibin alpha	BSB 5909	Myoglobin	BSB 5909	PSAP	BSB 6007	TTF-1
BSB 6834	INI-1	BSB 6351	Myosin Smooth Muscle	BSB 6351	PSMA	BSB 6014	Tyrosinase
BSB 2662	iNOS	BSB 2425	Napsin A	BSB 5930	PSP94/MSMB	BSB 3245	Uroplakin III
BSB 6841	Insulin	BSB 3175	Nestin	BSB 6994	PTEN	BSB 2299	Varicella Zoster Virus
BSB 2977	Islet 1 / ISL1	BSB 2160	NeuN	BSB 2006	PU.1	BSB 6056	VEGF
BSB 5707	Kappa Light Chains	BSB 5916	Neuroblastoma	BSB 2013	Renal Cell Carcinoma	BSB 6021	Villin
BSB 5714	Ki-67	BSB 6133	Neurofilament	BSB 5812	Retinoblastoma/ Rb	BSB 6028	Vimentin
BSB 6288	Ksp-Cadherin	BSB 5923	Neutrophil Elastase	BSB 2020	S-100	BSB 6035	WT1
BSB 3369	LAG-3 / CD223	BSB 2167	NGFR	BSB 3105	S100A1	BSB 6042	Zap-70
BSB 5721	Lambda	BSB 3182	NKX2.2	BSB 6295	S100A6		
BSB 6848	Langerin	BSB 3112	NKX3.1	BSB 3112	S100A8/MRP8		
BSB 3376	Langerin / CD207	BSB 3119	NRAS	BSB 3119	S100A9		
BSB 2935	Glutamine Synthetase	BSB 2669	NSE	BSB 2669	S100Beta		
BSB 5588	Glycophorin A	BSB 5826	OCT-2	BSB 2013	S100P		
BSB 6246	Glypican-3	BSB 2027	OCT-4	BSB 5812	SALL4		
BSB 5595	Granzyme B	BSB 2034	OLIG2	BSB 2020	SATB2		
BSB 5602	hCG	BSB 2565	Osteonectin/SPARC	BSB 3105	SMAD4/DPC4		
BSB 3355	HE4	BSB 3264	OX-40/CD134	BSB 6295	Smoothelin		
BSB 2683	Helicobacter Pylori	BSB 3126	p120 Catenin	BSB 2167	Somatostatin		
		BSB 2083	p21	BSB 3182	SOX-2		
		BSB 2069	p21	BSB 2174			

All Control Slides PK/5

320

IMMUNOHISTOCHEMISTRY

Control Slide Introduction

As the diagnostics market continues to grow, researchers and clinicians have a greater need for a wide variety of high quality and cost effective control slides. Control slides are invaluable tools utilized by institutions when validating reagents, qualifying new products, testing protocols or performing research which requires multiple tissue types. CDI control slides are cost effective, high quality tissues mounted on Hydrophilic Plus slides which are validated for use in immunohistochemical (IHC) and *in situ* hybridization (ISH) applications.

Normal Human TMA (NH-TMA)

The Normal Human Tissue Micro Array, or NH-TMA, is an excellent way to test an antibody, ISH probe or other reagent on multiple tissues. CDI NH-TMA arrays are available in both 11 or 23-core configurations. CDI NH-TMA's are an excellent way for clinics and research labs to save time and money by allowing multiple tissues to be tested on one slide.

All TMA's have been validated using immunohistochemical methods and are positive for over 100 antibodies. Additionally all TMA's can be custom ordered to be cut and placed on any slide including the CDI Hydrophilic Plus slide.

Tissue Micro Array Features

- Easy method of antibody validation.
- Cost effective diagnostic control.
- Test a large number of tissue types on one slide.
- Available in 11 or 23 core format.
- Validated for use with over 100 antibodies used in Immunohistochemistry.



Depiction of Normal Human 11 Core TMA

NH-TMA Map

The maps below outline the various normal tissue types used. Each slide comes with a "blank" core for easy orientation & interpretation.

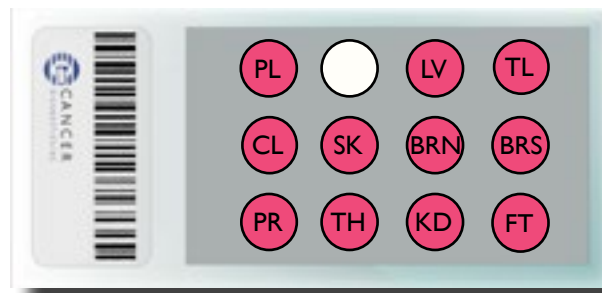

11 Core Normal Human Tissue Micro Array (NH-TMA) Key

PL - Placenta	Blank	LV - Liver	TL - Tonsil
CL - Colon	SK - Skin	BRN - Brain	BRS - Breast
PR - Prostate	TH - Thyroid	KD - Kidney	FT - Fallopian Tube

Refer to page **323-324** for Validated IHC Antibodies

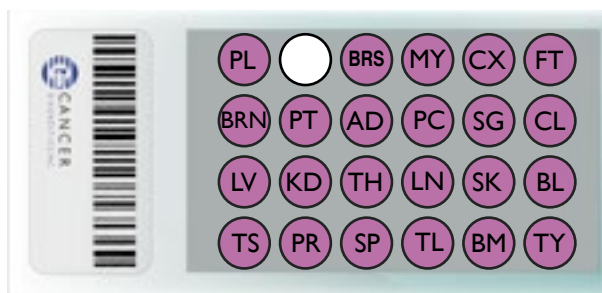

23 Core Normal Human Tissue Micro Array (NH-TMA) Key

PL - Placenta	Blank	BRS - Breast	MY - Myometrium	CX - Cervix	FT - Fallopian Tube
BRN - Brain	PT - Pituitary	AD - Adrenal	PC - Pancreas	SG - Salivary	CL - Colon
LV - Liver	KD - Kidney	TH - Thyroid	LN - Lung	SK - Skin	BL - Bladder
TS - Testis	PR - Prostate	SP - Spleen	TL - Tonsil	BM - Bone Marrow	TY - Thymus

NH-TMA Positive IHC Biomarkers

Positive IHC Biomarkers for 11 & 23-Core NH-TMA								
Actin S.M.	CD10	CD4	CD7	CK 5/6	Factor XIIIa	MART-1	PAX-2	Synpatophysin
AFP	CD15	CD43	CD79a	CK 7	GCDPF-15	NeuN	PAX-5	Thyroglobulin
AMACRacemase	CD1a	CD45	CD8	CK AE1	GFAP	NSE	PAX-8	TTF-1
bcl-1	CD20	CD45RA	CD99	CK CAM 5.2	HBME-1	Neurofilament	PIN-4	Vimentin
bcl-2	CD21	CD45RO	CD117	CK Cocktail	hCG	OC-125	PLAP	WT-1
bcl-6	CD23	CD5	CD138	Desmin	Hep-Par 1	p120	PR	More biomarkers can be used with NH-TMA's.
Ber-EP4	CD3	CD56	CDX-2	E-Cadherin	HMB-45	p57	PSA	
CA19-9	CD30	CD57	CEA	EMA	hPL	p63	RCC	
Calponin	CD31	CD68	Chromogranin A	ER	Ki-67	Pan Keratin	S100	
Calretinin	CD34		CK 20	Factor VIII	Mammoglobin	PMSA	TAG-72	

Sample NH-TMA IHC Stains

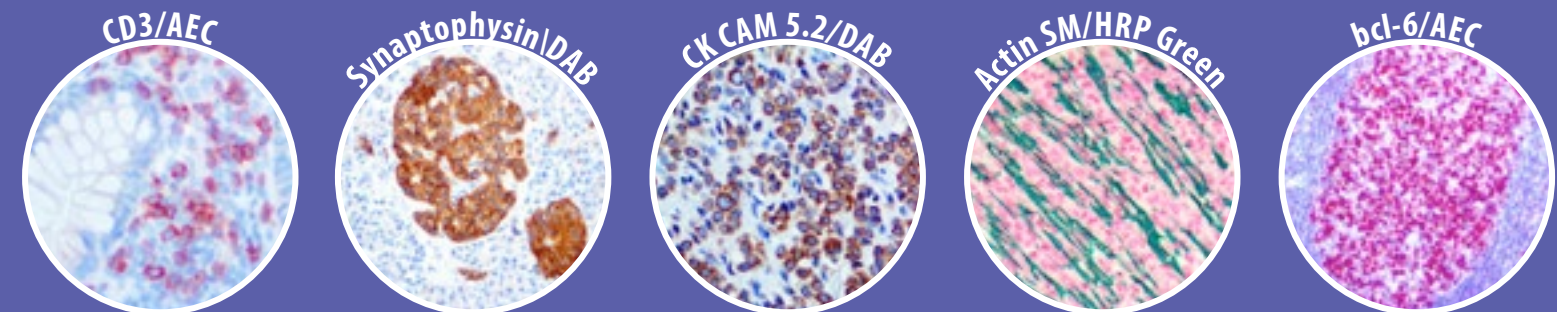

11 core Normal Human TMA Map Validated IHC Antibodies



PL Placenta	AFP EGFR	CD31 FVIII	CD34 FXIIIa	CK AE1 hCG	CK7 hPL	CK CAM p57	EMA S100
LV Liver	AMACR CK7	CD10 HepPar1					
TL Tonsil	bcl-2 bcl-6 CD1a CD3 CD79a Ki-67	CD4 CD5 CD7 CD8 CD117 Lambda	CD15 CD20 CD21 CD23 CD138 Pax-5	CD30 CD31 CD45RO CD34 CD43 CD45 CD68 EGFR Kappa	CD45RA CD45RO		
CL Colon	AMACR CA 19-9 CD38 CD56 CD117 CD138 CDX-2 CEA	Chrom. A CK20 EMA NSE Pan-Keratin PASd S-100 Synapt.					
SK Skin	CD117 CD1a CD23 CD31 CD138 CK AE1 CK5/6 EGFR	EMA FVIII FXIIIa HMB-45 Melan-A p63 Pan-Keratin S-100					
BRN Brain	HBME-1 GFAP NeuN	NF NSE S100					
BRS Breast (Fibroadenoma)	Calponin CAM5.2 CK AE1 CK7 E-Cadherin	EMA EpCam ER GCDFP-15 Mammoglobin	p120 Pan-Keratin PR TAG-72				
PR Prostate	Actin SM AMACR CK5/6 Desmin EMA	PSA PSAP PSMA PIN-4 p63/p40 Vimentin					
TH Thyroid	CK AE1/AE3 CK CAM CK7 EMA	Pan-Keratin Thyroglobulin TTF-1					
KD Kidney	AMACR CD10 Napsin	PAX-2 RCC					
FT Fallopian Tube	CA-125 Calretinin Desmin	ER PAX-8 WT-1	PR				
Blank	Orientation Core						

23 core Normal Human TMA Map Validated IHC Antibodies

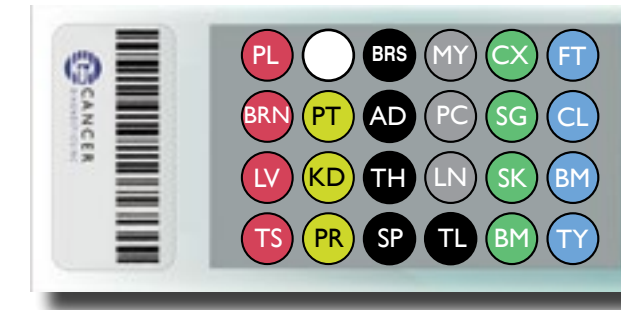

PL Placenta	AFP EGFR	CD31 FVIII	CD34 FXIIIa	CK AE1 hCG	CK7 hPL	CK CAM p57	EMA S100
BRN Brain	HBME-1 GFAP NeuN	NF NSE S100					
LV Liver	AMACR CD10	CK7 HepPar1					
TS Testis	Actin SM CD4 Inhibin MSH6	Oct 3/4 PLAP SALL4 WT-1					
BRS Breast (Fibroadenoma)	Calponin CAM5.2 CKAE1 CK7 E-Cadherin EMA EpCam	ER GCDFP-15 Mammoglobin p120 Pan-Keratin PR TAG-72					
MY Myometrium	Actin SM Caldesmon CD4 CD34	Desmin ER MSH6					
AD Adrenal	CD4 CD138 Inhibin-A	Melan-A Synaptophysin					
TH Thyroid	CK AE1/AE3 CK CAM CK7 EMA	Pan-Keratin Thyroglobulin TTF-1					
SP TL Spleen & Tonsil	bcl-2 bcl-6 CD1a CD3	CD4 CD5 CD7 CD8	CD15 CD20 CD21 CD43 CD45 CD68	CD30 CD31 CD45RO CD117 Ki-67 Lambda PAX-5 INI-1	CD45RA CD45RO EGFR*	Kappa PAX-5 *Tonsil Only	
PR Prostate	Actin SM AMACR CK5/6 Desmin EMA	PSA PSAP PSMA PIN-4 p63/p40 Vimentin					
PC Pancreas	bcl-10 Chrom. A	DOG-1 Synaptophysin					
LN Lung	CK7 CK AE1/AE3 CK CAM 5.2	EMA Pan-Keratin TTF-1					
SG Salivary Gland	Actin SM Calponin CD138	GCDFP S100 Vimentin					
SK Skin	CD117 CD1a CD23 CD31 CD138 CK AE1 CK5/6	EMA FVIII FXIIIa HMB-45 Melan-A p63 Pan-Keratin					
BM Bone Marrow	Annexin CD4 CD5 CD15 CD34 CD61	CD117 CD138 DBA-44 MP0 MSH6 Lysozyme					
FT Fallopian Tube	Calretinin Desmin ER CA-125	PAX-8 PR WT-1					
CL Colon	AMACR CA 19-9 CD38 CD56 CD117 CD138 CDX-2	Chrom. A CK20 EMA NSE Pan-Keratin PASd S-100					
BL Bladder - Transitional Cell Carcinoma	CD4 CK 5/6 CK7 CK20 GATA-3	MSH6 p40 p64 PAX-8					
TY Thymus (Lymphoblastic Lymphoma)	CD2 CD3 CD4	CD35 INI-1 TdT					
Blank	Orientation Core						

Positive Control Slides

CDI has over 36 types of formalin fixed paraffin embedded tissues and cell lines for your Immunohistochemical and *In situ* hybridization needs. Our large inventory of tissues ranging from Adrenal to Uterus allows us to provide unique cases that other companies cannot. All positive control slides are available in packs of five and are competitively priced. Ask us about custom TMA or positive control slides.

Tissue Micro Arrays

Item	Description
BSB 0230	Multi-Cancer TMA
BSB 0231	CD117/DOG-1 Gastrointestinal Stromal Tumor TMA
BSB 0297	11-Core NH-TMA
BSB 0298	23-Core NH-TMA
BSB 0299	NH Tonsil TMA

Cell Line Micro Arrays

Item	Description
BSB 0242	3-core GIST Cell Line Microarray
BSB 0243	5-core Melanoma Cell Line Microarray
BSB 0244	31-core Multi Cancer Cell Line Microarray
BSB 0292	9-core HER-2 Cell Line Microarray (0, +, 1+, 2+, 3+ in duplicates)
BSB 0293	7-core ER/PR Cell Line Microarray
BSB 0294	7-core HPV Cervical Cancer Cell Line Microarray
BSB 0295	7-core EGFR Cell Line Microarray
BSB 0296	3-core ALK Cell Line Microarray
BSB 0300	9-core PTEN Cell Line Microarray
BSB 0301	7-core PD-L1 Cell Line Microarray
BSB 0302	11-core Breast Cancer Cell Line Microarray
BSB 0303	3-core Neuroblastoma Cell Line Microarray
BSB 0304	11-core Immunotherapy Cell Line Microarray
BSB 0305	5-core BRAFV600E Cell Line Microarray
BSB 0306	3-core Lung Cancer Cell Line Microarray

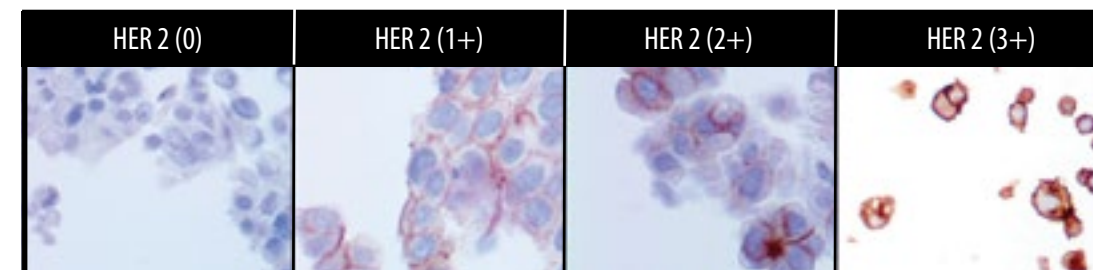

Above: HER-2 Cell Line Micro Array with various signal strengths.

Infectious Disease Array (ID-Array)

The CDI Infectious Disease cell line micro array, or ID-Array is a simple and cost effective way to test and validate infectious disease markers by immunohistochemical (IHC) or in situ hybridization (ISH). The infectious disease micro array is available in a 9-core or Individual virus configuration, and includes two areas for tissue mounting. All TMA's include negative controls to reduce interpretation error.

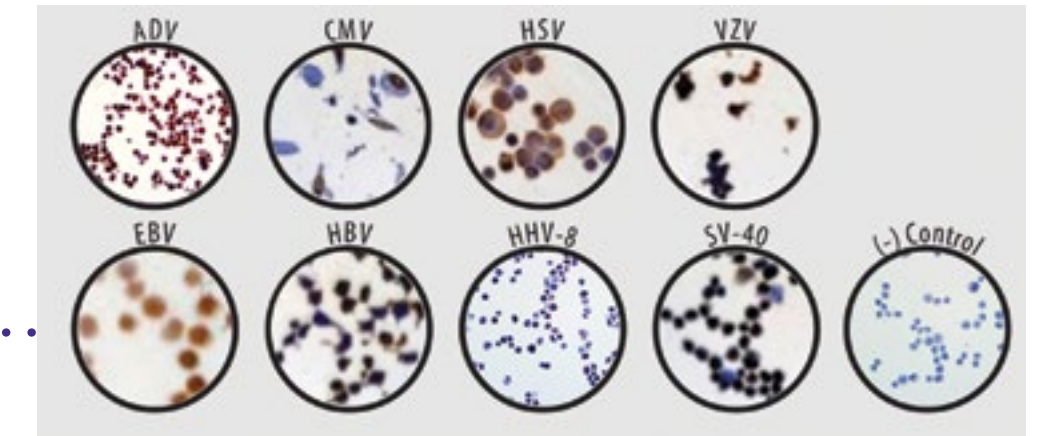
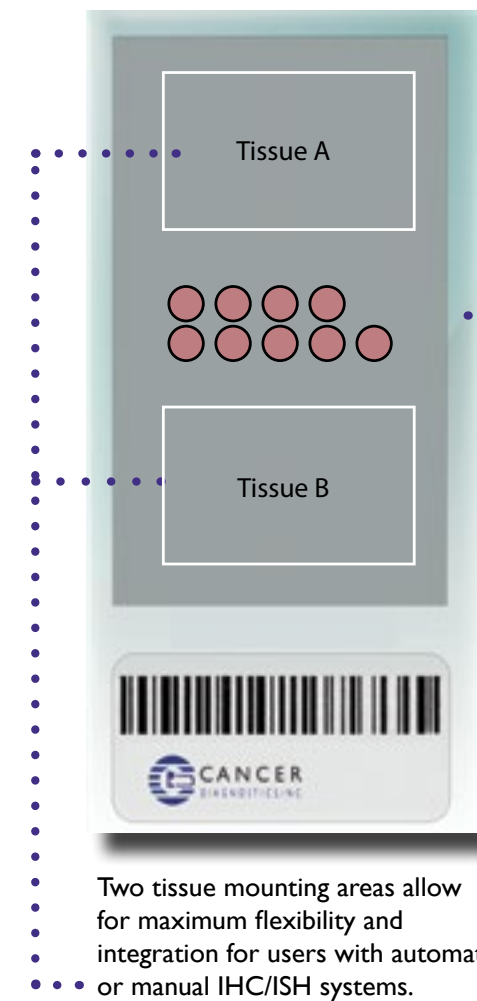

Above: 9-Core Multi-Infectious Disease Cell Line Array (BSB 0232)

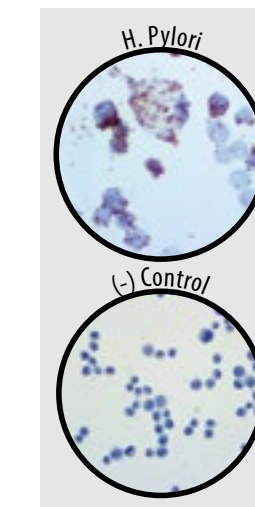

Above: 2-Core H. Pylori Cell Line Array (BSB 0241).

Item	Description
BSB 0232	Multi ID-Array (9-Core)
BSB 0233	Adenovirus ID-Array (2-Core)
BSB 0234	CMV ID-Array (2-Core)
BSB 0235	HSV ID-Array (2-Core)
BSB 0236	VZV ID-Array (2-Core)
BSB 0237	EBV ID-Array (2-Core)
BSB 0238	HBV ID-Array (2-Core)
BSB 0239	HHV-8 ID-Array (2-Core)
BSB 0240	SV-40 ID-Array (2-Core)
BSB 0241	H.Pylori ID-Array (2-Core)

ID-Array

- Test multiple infectious disease markers.
- Optimized for IHC & ISH Applications.
- Cost effective solution.
- Test multiple samples at once.
- Two control tissue mounting areas for Manual or Automated IHC/ISH users.



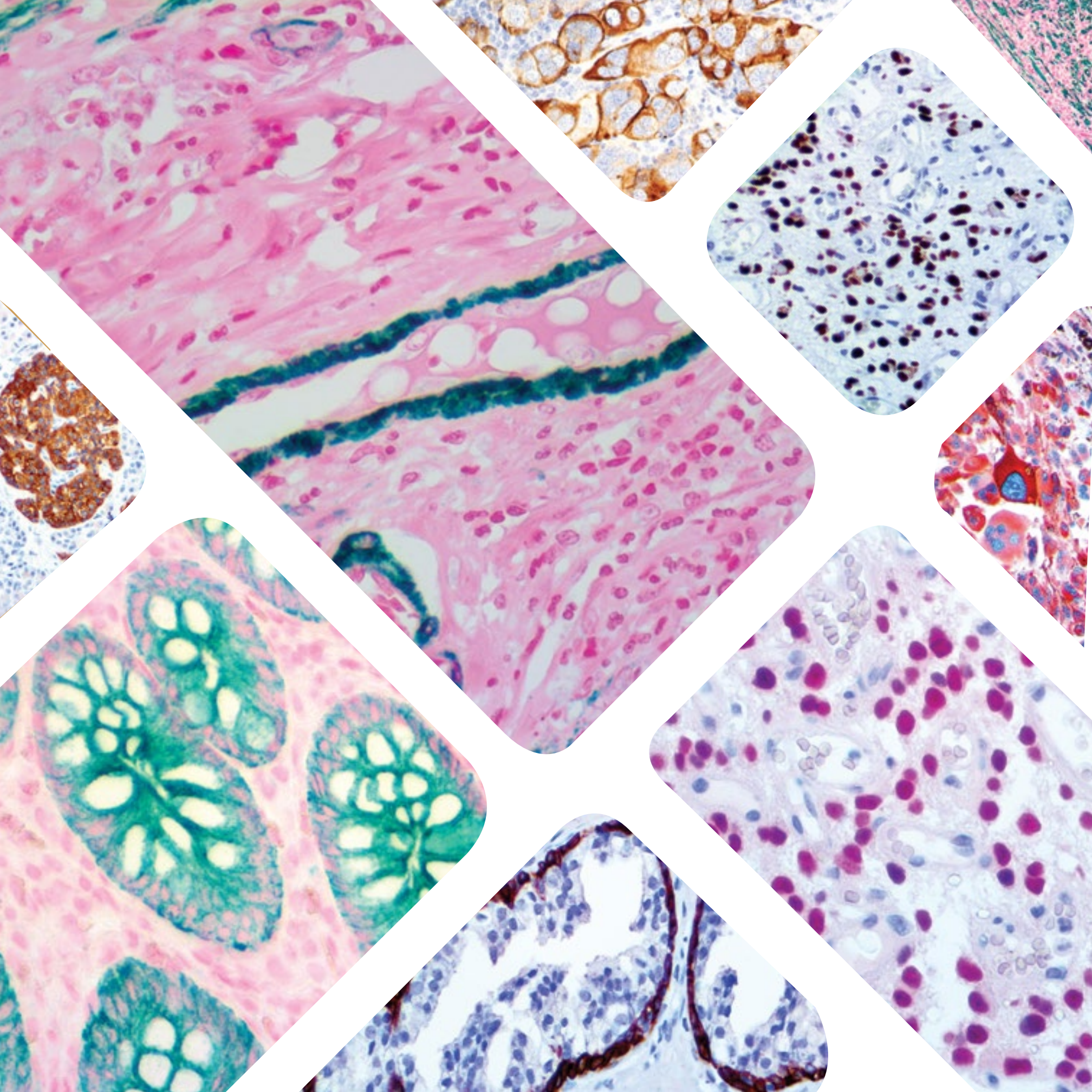

Ancillaries



CAT. #	PRESENTATION	VOL
Non-Toxic Deparaffinization Solutions – Xylene and Alcohol Substitutes		
BSB 0134	TintoDeparaffinator 1	1 Lt
BSB 0135	TintoDeparaffinator 1	4 Lt
BSB 0136	TintoDeparaffinator 2	1 Lt
BSB 0137	TintoDeparaffinator 2	4 Lt
Retrievers and Enzymes		
BSB 0023	ImmunoRetriever 20X with Citrate	50.0 ml
BSB 0020	ImmunoRetriever 20X with Citrate	200.0 ml
BSB 0021	ImmunoRetriever 20X with Citrate	500.0 ml
BSB 0022	ImmunoRetriever 20X with Citrate	1000.0 ml
BSB 0033	ImmunoRetriever 20X with EDTA	50.0 ml
BSB 0030	ImmunoRetriever 20X with EDTA	200.0 ml
BSB 0031	ImmunoRetriever 20X with EDTA	500.0 ml
BSB 0032	ImmunoRetriever 20X with EDTA	1000.0 ml
BSB 0108	ImmunoDNA Digestor	15.0 ml
BSB 0109	ImmunoDNA Digestor	50.0 ml
BSB 0110	ImmunoDNA Digestor	100.0 ml
BSB 0111	ImmunoDNA Digestor	200.0 ml
BSB 0112	ImmunoDNA Digestor	1000.0 ml
Dilutents and Blockers		
BSB 0113	ImmunoDetector Protein Block / Antibody Diluent	15.0 ml
BSB 0040	ImmunoDetector Protein Block / Antibody Diluent	50.0 ml
BSB 0041	ImmunoDetector Protein Block / Antibody Diluent	100.0 ml
BSB 0114	ImmunoDetector Protein Block / Antibody Diluent	200.0 ml
BSB 0115	ImmunoDetector Protein Block / Antibody Diluent	1000.0 ml
BSB 0103	ImmunoDNA Background Blocker	15.0 ml
BSB 0104	ImmunoDNA Background Blocker	50.0 ml
BSB 0105	ImmunoDNA Background Blocker	100.0 ml
BSB 0106	ImmunoDNA Background Blocker	200.0 ml
BSB 0107	ImmunoDNA Background Blocker	1000.0 ml
BSB 0050	PolyDetector Peroxidase Block	15.0 ml
BSB 0051	PolyDetector Peroxidase Block	50.0 ml
BSB 0052	PolyDetector Peroxidase Block	100.0 ml
BSB 0053	PolyDetector Peroxidase Block	200.0 ml
BSB 0054	PolyDetector Peroxidase Block	1000.0 ml
BSB 0055	PolyDetector AP Block	15.0 ml
BSB 0056	PolyDetector AP Block	50.0 ml
BSB 0057	PolyDetector AP Block	100.0 ml
BSB 0058	PolyDetector AP Block	200.0 ml
BSB 0059	PolyDetector AP Block	1000.0 ml
BSB 0098	ImmunoDetector Biotin Blocker	15.0 ml
BSB 0099	ImmunoDetector Biotin Blocker	50.0 ml
BSB 0100	ImmunoDetector Biotin Blocker	100.0 ml
BSB 0101	ImmunoDetector Biotin Blocker	200.0 ml
BSB 0102	ImmunoDetector Biotin Blocker	1000.0 ml

CAT. #	PRESENTATION	VOL
Primary Antibody Negative Controls		
BSB 0040A	Mouse Negative Control	3.0 ml
BSB 0040B	Mouse Negative Control	6.0 ml
BSB 0040C	Mouse Negative Control	15.0 ml
BSB 0041A	Rabbit Negative Control	3.0 ml
BSB 0041B	Rabbit Negative Control	6.0 ml
BSB 0041C	Rabbit Negative Control	15.0 ml
Washers and Detergent		
BSB 0029	Immuno/DNA Washer 10X	200.0 ml
BSB 0042	Immuno/DNA Washer 10X	1000.0 ml
BSB 0045	Tween 20	100.0 ml
BSB 0046	Tween 20	500.0 ml
Mounting Media		
BSB 0090	Aqua Mounter	15.0 ml
BSB 0091	Aqua Mounter	50.0 ml
BSB 0092	Aqua Mounter	100.0 ml
BSB 0093	Aqua Mounter	500.0 ml
BSB 0094	Perma Mounter	15.0 ml
BSB 0095	Perma Mounter	50.0 ml
BSB 0096	Perma Mounter	100.0 ml
BSB 0097	Perma Mounter	500.0 ml
Counterstainers		
● BSB 0024	Hematoxylin Counterstainer	15.0 ml
● BSB 0025	Hematoxylin Counterstainer	50.0 ml
● BSB 0026	Hematoxylin Counterstainer	100.0 ml
● BSB 0027	Hematoxylin Counterstainer	200.0 ml
● BSB 0028	Hematoxylin Counterstainer	1000.0 ml
● BSB 0116	Nuclear Fast Red Counterstainer	15.0 ml
● BSB 0117	Nuclear Fast Red Counterstainer	50.0 ml
● BSB 0118	Nuclear Fast Red Counterstainer	100.0 ml
● BSB 0119	Nuclear Fast Red Counterstainer	200.0 ml
● BSB 0120	Nuclear Fast Red Counterstainer	500.0 ml
● BSB 0121	Nuclear Fast Red Counterstainer	1000.0 ml
● BSB 0122	Methyl Green Counterstainer	15.0 ml
● BSB 0123	Methyl Green Counterstainer	50.0 ml
● BSB 0124	Methyl Green Counterstainer	100.0 ml
● BSB 0125	Methyl Green Counterstainer	200.0 ml
● BSB 0126	Methyl Green Counterstainer	500.0 ml
● BSB 0127	Methyl Green Counterstainer	1000.0 ml

IVD For *in Vitro* Diagnostic Use

1-877.846.5393

CANCERDIAGNOSTICS.COM

CYTOLOGY



CYTOLOGY PREPARATION, COLLECTION, ANALYSIS

Collection Devices • Centrifuge Tubes

Cytology Funnels/Slides • Cytology Stains • Cytology Fixatives





Cervex-Brush® Original

The Cervex-Brush® ORIGINAL is an endocervical cell collection device for simultaneously collecting cervical and endocervical cells by the clinician during a pap smear. Ideal for use in collecting OBGYN specimens for liquid base cytology procedures.

Item	Description	Qty
NYL0907	Cervical Cell Sampler	PK/25



Cervex-Brush® Combi

The Cervex-Brush® Combi is capable of delivering higher cellular yield of endocervical cells than the traditional Cervex-Brush®. Laboratory tests have also indicated presence of oncogenic HPV type cells which will encourage other applications for the Cervex-Brush® Combi.

The Cervex-Brush® Combi was developed for two main reasons. For current users of the Cervex-Brush® a perfect smear can be made in the majority of the cases if the instructions for use are followed properly. In a small percentage of cases (stenotic os or narrow entry of the endocervical canal) sometimes a more rigid endocervical sample is needed.

Item	Description	Qty
NYL0907-C	Cervical Cell Sampler	PK/25



Rovers® EndoCervex-Brush®

Rovers® EndoCervex Brush® is a one piece cytology brush designed to optimize cellular yield in Pap smear specimen collection. The EndoCervex Brush® provides 600 separate collection "bristles" for the simultaneous collection of cellular material. The Brush features a stiff yet flexible bristle head with a protective tip to enhance the overall collection process. A safety ring just below the bristle head will decrease the possibility of the Brush entering the endometrium during collection. The brush head is detachable after collection.

Rovers® EndoCervex-Brush®-S designed for adolescent and nulliparous women, or elderly women with a retracted transformation zone and/or stenotic entry of the endocervical canal. A safety ring just below the bristle head will decrease the possibility of the brush entering the endometrium during the collection process. The head of the brush is detachable after collection is complete. *For Ectocervical cell collection, refer to Rovers® Spatula.*

Item	Description	Qty
ECB0907	Rovers® EndoCervex Brush®	CS/1000
ECS0907	Rovers® EndoCervex Brush®-S	CS/1000



The Wallach Papette®

A device designed to gather both endo and ectocervical cells including those in the transformation zone. Unique, softer LDP bristles with slip agent gather full spectrum of cells in a one-step procedure.

Item	Description	Qty
WP090C	Wallach Papette®	PK/100
WP090M	Wallach Papette®	CS/1000

Cervical Brush (Snap-Tip)

Cervical Brush (Snap -Tip) works with today's liquid based cytology automated systems. The Brush comes in a 7 1/2" length with the brush top portion featuring an easy Snap-Tip feature. This portion can then easily be dropped into a preparation jar for transport.

Item	Description	Qty
SPH500-CDI	Snap-Tip	CS/500
SPH000-CDI	Snap-Tip	PK/100

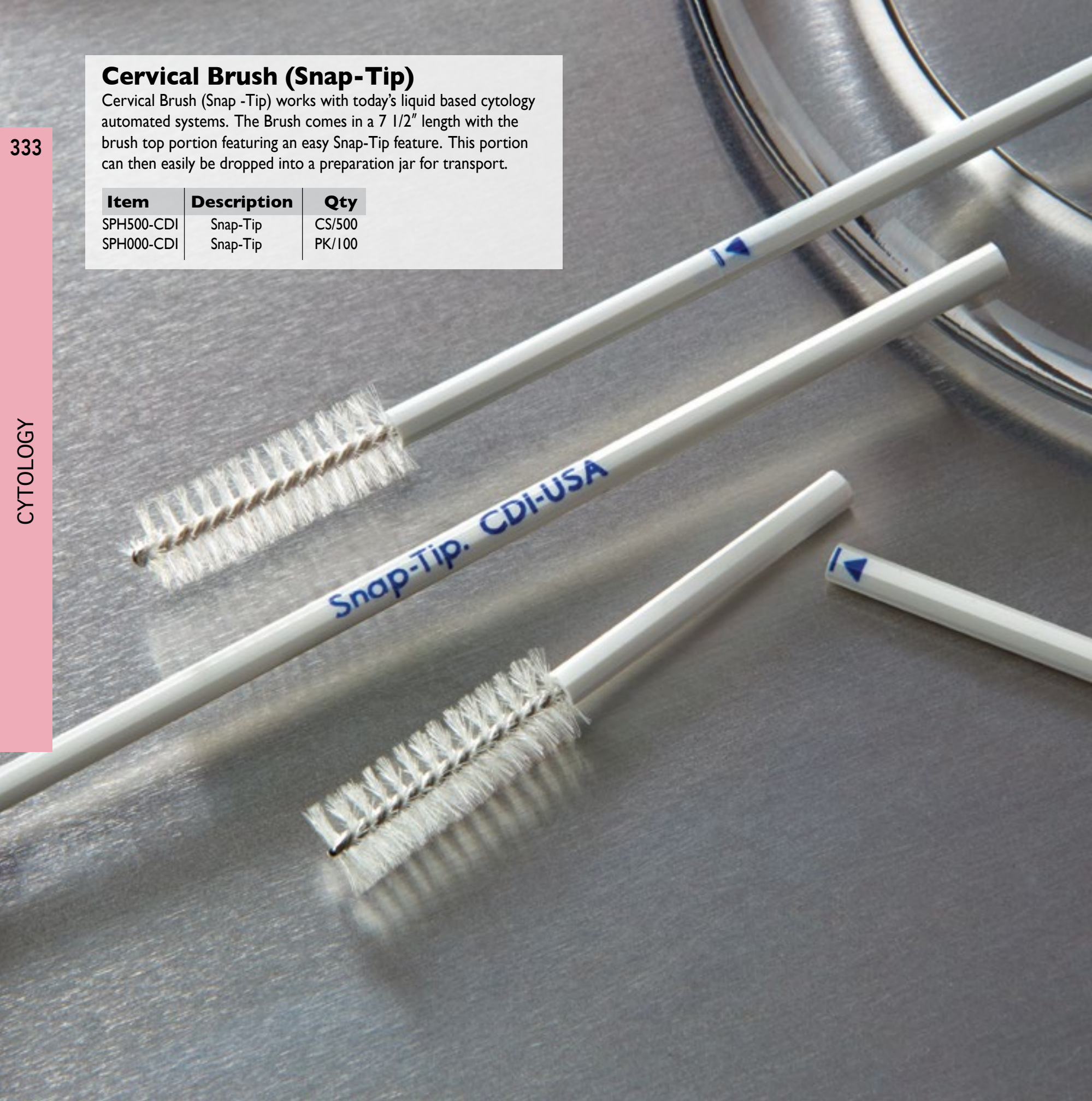

Cytology Clarifier™

An optimal differentiator for the regressive staining method in cytology resulting in crisp, stained nuclei.

Item	Volume	Qty
FX2103	Gal (3.8L)	CS/4

CytoStain-Bluing™, Cytology Bluing Solution

A cytology bluing solution formulated to optimally blue both regressive and progressive papanicolaou and non gyn specimens. Gentle alkaline reagents minimize cell loss from glass.

Item	Volume	Qty
FX2107	Gal (3.8L)	CS/4



OG-6, EA-36, EA-50, Modified EA-50, EA-65 and EA-OG™ Cyto-Stain

Orange G-6 is an alcohol-based stain used in the cytology laboratory to detect the presence of keratin in the cytoplasm. This formula is pre-filtered before bottling and is manufactured for optimal consistency.

EA-36 and EA-50 are used in conjunction with OG-6 for gynecological staining.

EA-65 is used with OG-6 for non-gynecological staining.

Modified EA-50 is a Gill modification that minimizes precipitation, reduces staining time, and does not contain Bismarck Brown.

EA-OG™, Cytology Combination Counterstain

A rapid cytology stain formulated as a one-step counterstain. EA-OG™ combination cytology stain will deliver consistent staining while increasing efficiency in the staining process.

EA-36

Item	Description	Qty
CM3651	500 mL	EA.
CM3652	Liter (1000 mL)	EA.
CM3653	Gal. (3.8 L)	EA.

EA-50

Item	Description	Qty
CM8951	Gal. (3.8 L)	EA.
CM8952	Liter (1000 mL)	EA.
CM8953	500 mL	EA.

EA-50 Modified

Item	Description	Qty
CM8954	Gal. (3.8 L)	EA.
CM8955	Liter (1000 mL)	EA.
CM8956	500 mL	EA.

EA-65

Item	Description	Qty
CM9951	Gal. (3.8 L)	EA.
CM9952	Liter (1000 mL)	EA.
CM9953	500 mL	EA.

OG-6

Item	Description	Qty
CM7951	Gal (3.8L)	EA.
CM7952	Liter (1000 mL)	EA.
CM7953	500 mL	EA.

EA-OG™ Cyto-Stain

Item	Description	Qty
CM8977	500 mL	EA.
CM8978	Liter (1000 mL)	EA.
CM8979	Gal (3.8L)	EA.



CF2™-Cytology Fixing Fluid

CF2™ Cytology Fixing Fluid is formulated for improved fixation of all body fluids and cytospin preparations. Nuclear and cytoplasmic detail are distinct, and fixation and staining are enhanced in comparison to alcohol fixed specimens. Erythrocytes are lysed and do not obscure the nucleated cells of interest.

Item	Volume	Qty
FX1090	Gal (3.8L)	EA.
FX1091	120mL	CS/96 (16/BX, 6 BX/CS)
PMP1000	Gallon Pump	EA.



Pump Available PMP1000

Pre-Filled

Saccomanno Fixative

Saccomanno's Cytology Fixative is a widely used fixative in cytology for specimens such as FNA'S, urine, sputums, bronchial washings, pleural and peritoneal fluids, and sputum preparations.

Saccomanno's Cytology Fixative's low alcohol content partially fixes the specimen's cells to protect the cellular integrity, making it a great pre-fixative for cytology specimens that must be transported or held for some time.

The Saccomanno Method for sputum separates mucus from the specimen cells so the cells can be evenly spread onto a microscope slide. In the Saccomanno Method for sputum, the sputum is placed into the Saccomanno's Fixative and

then the sputum is homogenized in a micro-blender where the cells of the sputum are forced into the tip of the centrifuge tube while the mucus stays in suspension. The supernatant with the mucus is then poured out and the cells are collected to make a smear.

Item	Volume	Qty
SF0037	Gal (3.8L)	CS/4
SF0038	Gal (3.8L)	EA.
SF0120	120mL	CS/96 (16/BX, 6 BX/CS)
PMP1000	Gallon Pump	EA.



Saccomanno's Fixative
CYTOLOGY FIXATIVE

SF0037 1 GAL (3.8L)
 SF0038-WP 1 GAL (3.8L) w/ PUMP
 SF0120 1 GAL (3.8L) 4CS
 SF0037-WP 1 GAL (3.8L) 4CS w/ PUMP
 SF0120P 5 GAL (19L) CUBE

For In Vitro Diagnostics Use



Lyse Red
Preservative Fixative

LR-2004 509ML
 LR-2001 1 GAL (3.8L)

For In Vitro Diagnostics Use



Pump Available PMP1000

Lyse Red

Lyse-Red™ is an alcohol-based, hemolytic general-purpose fixative solution. It is intended for cytology and small biopsy processing. Its active ingredients are comprised of alcohols, formaldehyde, and non-toxic emollients, demulcents and buffers. It is used to prepare cells and small tissue fragments for cytological and histological examination. Lyse-Red™ lyses red blood cells, solubilizes many proteins, and fixes cells and small tissue fragments. It is compatible with IHC staining and results are similar to those achieved with neutral buffered formalin. Use for non-gynecological cytology specimens.

Item	Volume	Qty
LR-2001	Gal. (3.8L)	EA.
LR-2002	120mL	CS/96 (16/BX, 6 BX/CS)
LR-2004	20mL	CS/256
PMP1000	Gallon Pump	EA.

Pap-Spray™, Pap Fixative

Pap Spray™ is a polyethylene glycol formulation for rapid, high quality fixation of cytology cell spreads. A convenient fine-mist sprayer covers cells with a layer that protects cell morphology yet is water and alcohol soluble. 5 oz spray bottles for economical fixation.

Item	Size	Qty
FX1086	5 oz spray pump	CS/12



4 Slide Jar Pre-Filled with 95% Ethyl Alcohol

4 Slide Jar and tray with leak proof top pre-filled with 95% Ethyl Alcohol, Labeled.

Item	Description	Qty
004095	Slide Jar	CS/50
004095-200	Slide Jar	CS/200



CytoSpin Slides

75mm x 25mm slides printed with single or double circles on their surface. Each well is placed in the exact position where the centrifuge specimen is deposited making the smears easy to locate.

Item	Description	Qty
CS1	One Circle, Non Charged	PK/100
CS2	Two Circles, Non Charged	PK/100
CS1P	One Circle, Adhesive	PK/100
CS2P	Two Circles, Adhesive	PK/100

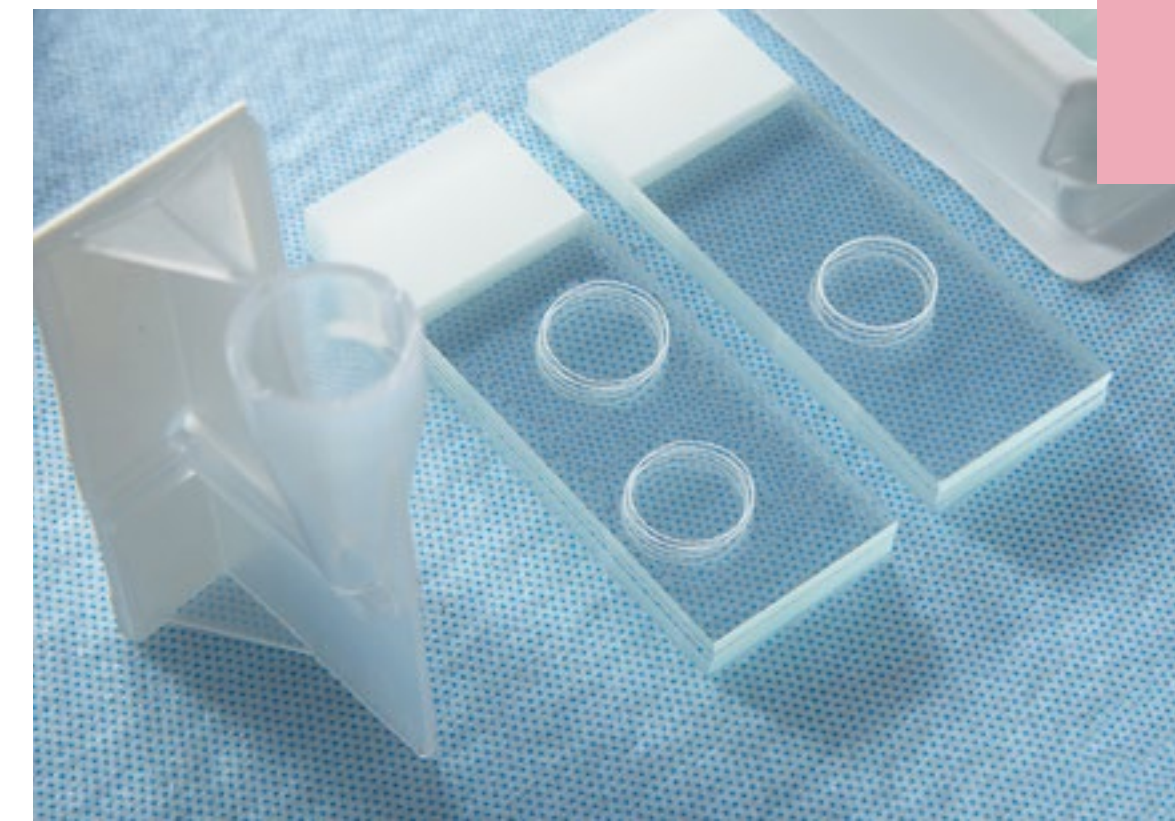

ThinLayer™ Liquid Based Cytology



ThinLayer™ Filters, Urine Cell (Yellow)

Use with urine specimens for cytology and/or slide-based molecular testing. Deposits a thin-layer of cells onto glass slides in a 10 mm diameter circle. Works on existing liquid based cytology equipment.

Item	Description	Qty
1URI-100F	ThinLayer™ Filters (Urine Cell)	BX/100
1URI-500F	ThinLayer™ Filters (Urine Cell)	CS/500



ThinLayer™ Filters, Non-Gyn (Blue)

Precision filtration transfers thin layer of cells (Thyroid FNA, Sputum, Body fluids) onto glass slides in a 20 mm diameter circle. Works on existing liquid based cytology equipment.

Item	Description	Qty
1NGYN-100F	ThinLayer™ Filters (Non-Gyn)	BX/100
1NGYN-500F	ThinLayer™ Filters (Non-Gyn)	CS/500

ThinLayer™ Liquid Based Cytology



ThinLayer™ Cell Lysing Solution, Non-Gyn

Lysis Solution. Same solution as is in ThinLayer™ Non-Gyn vials. Bottle of 32oz (946 mL)

Item	Description	Qty
1NGYN-LS	ThinLayer™ 32oz (946 mL) Cell Preserve Solution	CS/4

ThinLayer™ Cell Preserve Solution, Non-Gyn

Non-gynecological preservation solution. Same solution as is in ThinLayer™ Blue Cap vials. Bottle of 32oz (946 mL)

Item	Description	Qty
1NGYN-FF	ThinLayer™ 32oz (946 ml) Cell Preserve Solution	CS/4



ThinLayer™ Vial Cell Preserve Solution, Non-Gyn

ThinLayer™ Vial for Non-Gyn Liquid based cytology. Non-gynecological vials. Blue Cap.

Item	Description	Qty
1NGYN-100V	ThinLayer™ 20mL Vial Cell Preserve Solution (Non-Gyn)	CS/100
1NGYN-500V	ThinLayer™ 20mL Vial Cell Preserve Solution (Non-Gyn)	CS/500

Centrifuge Tubes



Centrifuge Tubes

Available in polypropylene materials most commonly used in centrifugation procedures. Leak proof design. Easy on/easy off blue cap. Clear accurate graduations.

Centrifuge Tube (Sterile)

Dimensions: 30X115mm
Capacity: 5mL to 50mL
Graduation interval: 2.5mL

Item	Description	Vol	Qty
CTS050	Sterile, Conical Bottom	50mL	CS/500

Centrifuge Tube (Self Standing)

Dimensions: 30X115mm
Capacity: 5mL to 45mL
Graduation interval: 2.5mL

Item	Description	Vol	Qty
CTG050	Conical Bottom Self Standing	50mL	CS/500

Centrifuge Tube

Dimensions: 17X120mm
Capacity 1.5mL to 13.5mL
Graduation interval: 2.5mL

Item	Description	Vol	Qty
CTG015	Conical Bottom	15mL	CS/500

Cytology Funnels



Cytology Funnel, All-plastic, Single & Double (No metal clips needed)

The complete, disposable funnel includes the filter cards, and eliminates the need for cleaning and time consuming decontamination. These single-use funnels do not need metal clips. White filter cards are used for sample volumes up to 0.5 ml. Brown filter cards are for sample volumes up to 0.4 ml. The cell deposition area is 6 mm in diameter (28 mm squared). **Each component also available separately.**

Item	Description	Qty
FX3109	Single Funnel with White Filter and Cap	CS/480
FX3111	Single Funnel with Brown Filter and Cap	CS/480
FX3109-DBL	Double Funnel with White Filter and Cap	CS/480

Cytology Funnels

345

CYTOLOGY



Cytology Funnel, Single & Double (use with Metal Clips)

Designed for the Shandon CytoSpin centrifuge, these funnels deposit a thin layer of cells in a clearly defined area of a microscope slide. Funnels have the filter cards pre-attached for consistent, reliable results. The filter card absorbs any excess fluids. All disposable funnels are packaged with closure caps to seal specimen for added protection and are also available individually wrapped.

Funnels are available with white or brown filter cards. For sample volumes up to 0.5 ml, use the funnel with a white filter card and cap. It provides a cell deposition area of 6mm (28 mm squared) and allows one sample to be run simultaneously on a single slide.

For sample volumes up to 0.4 ml, such as spinal fluids for example, use the funnel with brown filter card and cap. It allows for slower absorption of fluids.

The double cytology funnel with disposable sample chamber allows for two samples to be run simultaneously on a single slide and is ideal for immunohistochemistry work. The double funnel provides a cell deposition area of 6mm (28mm squared) for sample volumes up to 0.5 ml. The filter cards come pre-attached. Cap is included. Can be used with all stainless steel slide clips. **Each component also available separately.**

Item	Description	Qty
FX3101	Single Funnel with White Filter and Cap	CS/500
FX3101-A	Single Funnel with White Filter and Cap (individually wrapped)	CS/500
FX3107	Single Funnel with Brown Filter and Cap	CS/500
FX3101-DBL	Double Funnel with White Filter and Cap	CS/500
FX3101-DBL-A	Double Funnel with White Filter and Cap (individually wrapped)	CS/500
FX3102	Single Funnel	CS/500
FX3103	Cap	CS/500
FX3104	White Filter Paper	CS/200
FX3105	Brown Filter Paper	CS/200

Filter Paper



346

CYTOLOGY



CytoSep™ Cytology Funnel

The CytoSep™ Cytology Funnel offers the 1 ml fluid chamber component including the 1 ml fluid chamber, 1 mL base holder, 1 mL chamber cap and filter paper. All components are available separately.

Item	Description	Qty
M963-I	CytoSep Fluid Chamber, 1ml (Sakura 4329)	CS/200
M963B	CytoSep Base Holder for M963-I (Sakura 4336)	CS/200
M963C	CytoSep Cap Only for M963-I (Sakura 4335)	CS/200
M963FW	White Filter Card (Sakura 4333)	CS/200

Use with Sakura
Cyto-Tek® Cyto centrifuge



EQUIPMENT

PRECISION DOWN TO THE SMALLEST DETAIL - FOR
RELIABLE RESULTS IN HISTOLOGY AND PATHOLOGY

Spin Tissue Processor • Paraffin Dispensers • Cassette Printer
Slide Printer • Cassette Trimming • Embedding Centers
Microtomes • Tissue Stainers • Water Baths

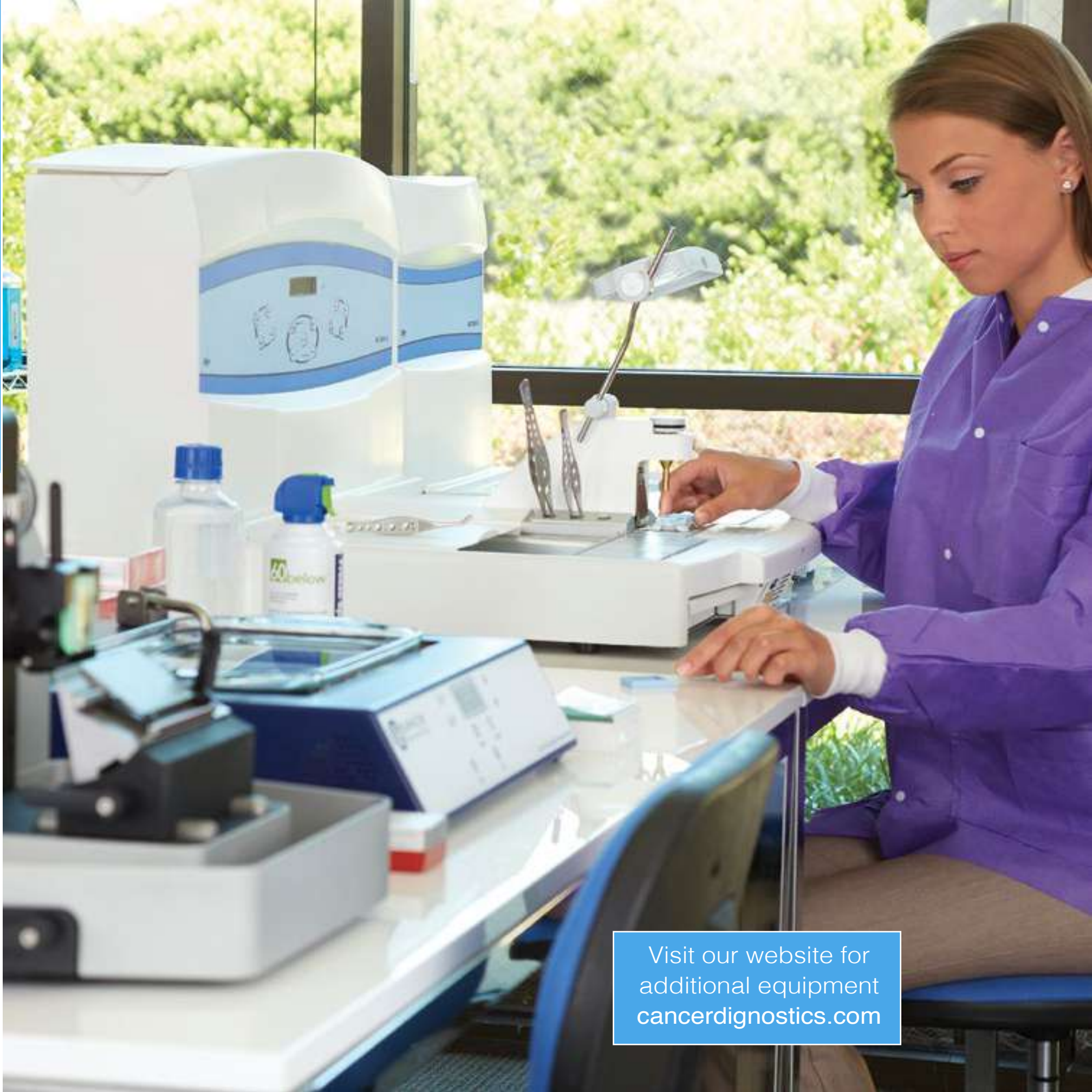

Visit our website for
additional equipment
cancerdiagnostics.com

WATER BATHS

OPTIMIZED
TEMPERATURE
CONTROL.
LONG
LASTING
DEPENDABILITY



Water Baths



Item: WB1 - Standard Tissue Flotation Bath (temp controlled, l.e.d. light, w/ pyrex dish)
Item: WB2 - Deluxe Tissue Flotation Bath - temp controlled, l.e.d. light w/ pyrex dish, slide dryer and tissue orientor blocks (Pictured Above)

Water Bath-Standard and Deluxe

- Eliminate wrinkles and distortion during preparation of paraffin embedded tissue sections.
- L.E.D. illuminated black background with transparent removable Pyrex dish; allows specimen to be easily seen and water easily discarded after use.
- Digital microprocessor control with advanced safety over temperature protection.
- Electrical certified to UL61010-1, CSA C22.2 and CE.
- Deluxe model includes Slide Dryer Block to assist in drying of slides and Tissue Orientor Block to smooth wrinkled sections.
- Internal memory retains the previous set temperature after power off/on.
- Supplied With: Removable Borosilicate glass dish, Part Number: WB7

Dimensions
114mm (Height)
362mm (Long)
362mm (Deep)

Weight
5.44kg

Round Water Bath

Item: WB40 - Round Water Bath



- Equipment is built with high strength pu resin, external finishing in white epoxy paint.
- The aluminum inner tank, with black electrostatic powder paint, provides an excellent view of the histological sections and high resistance to oxidation.
- Wide borders provide accommodation and pre-heating of slides.
- On/off key with led indicator.
- Temperature control: room temperature up to 90 degrees with a variation of + / - 2 degrees through digital thermostat.
- Thermal protector for disarming high temperature to reach 100°C. General shutdown of the equipment. Automatic reset when the temperature drops 95°C.

Dimensions
100mm (Height)
260mm (Inner Dimension)
360mm (Outer Dimension)

Weight
2.5kg

MOHS and Special Stains Stainer

Item: MS2250

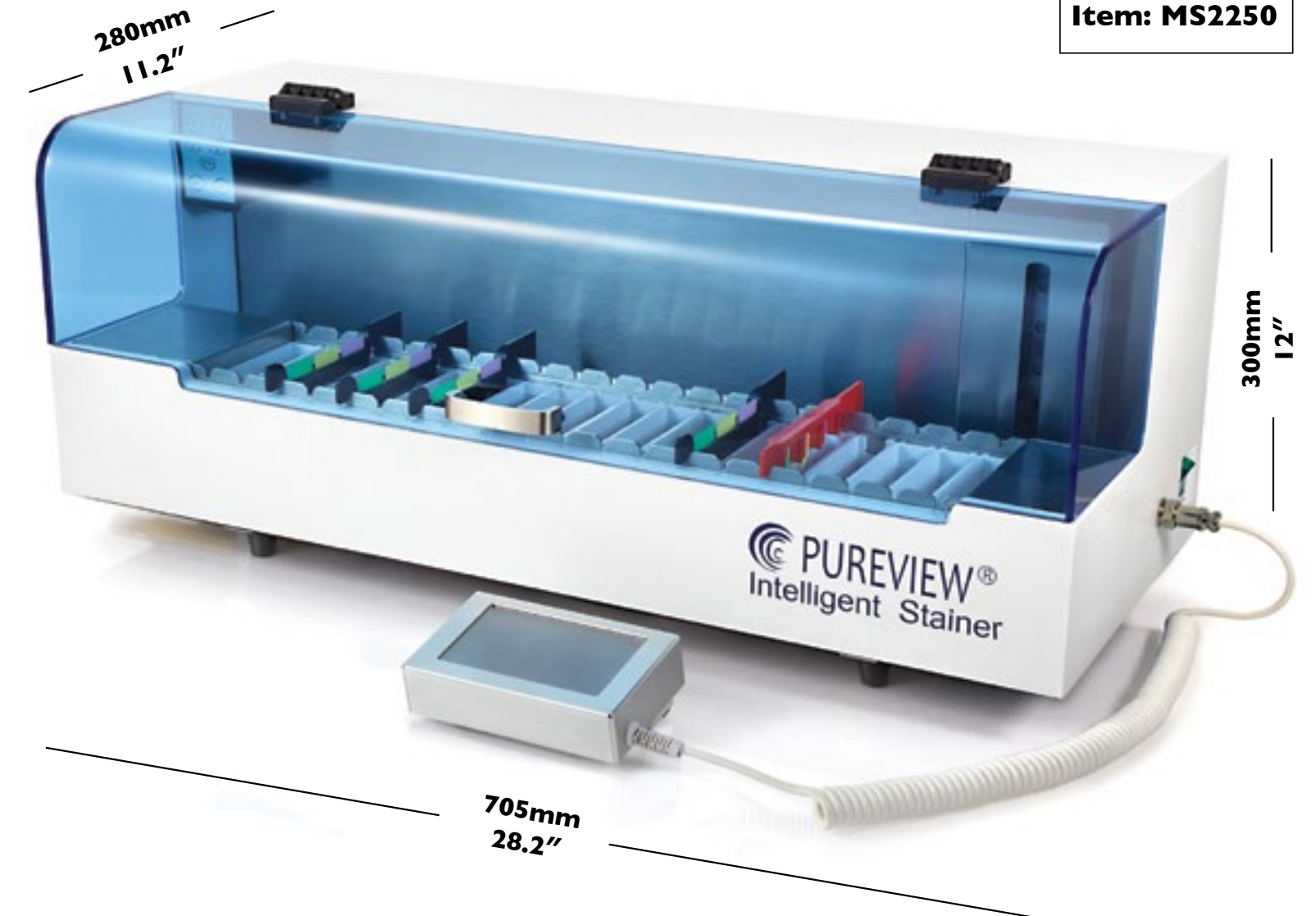

We recently trialed and then purchased a **Pureview® Intelligent Stainer** to use in our Mohs lab. We have a Mohs surgeon who does Mohs surgeries two days per week. The Pureview® has been wonderful! It's easy to set up, program, and adjust. We've found that the staining quality is on par with a routine regressive H & E stain. The staining is always consistent. Maintenance of the stainer is very little.

The ability to adjust timing on each station has been a great advantage to have. The Pureview® frees up time and hands enabling us to process more frozen specimens faster.

Minga Vargas
HT (ASCP)cm Histotechnician
Sutton Dermatology +Aesthetics

Pureview® Intelligent Stainer

This compact automated slide stainer features an instrument screen to continuously monitor the staining process. Simultaneous routine staining can be done within the same staining protocol allowing multiple racks at one time.

The Pureview® Intelligent Stainer is the perfect instrument for routine staining in a MOHS lab. It also meets the requirements for special, user-specified staining protocols for special stains.

User can load slide racks at any point of the program, achieving efficiency and flexibility for high throughput staining.

- 20 stations available, with optional dipping/agitation capabilities.
- Stations can all be programmed for individual times (not fixed time in each cup).
- Can process up to 5 racks (6-slides per rack) simultaneously.
- Easy touch screen programming can show times in each cup, or location of each rack.
- Can be also used as special stains stainer.



•
✕
Dimensions
300mm (Height)
705mm (Long)
280mm (Deep)
•
⊙
Weight
20kg

Tissue Stainer

Item: SS-30

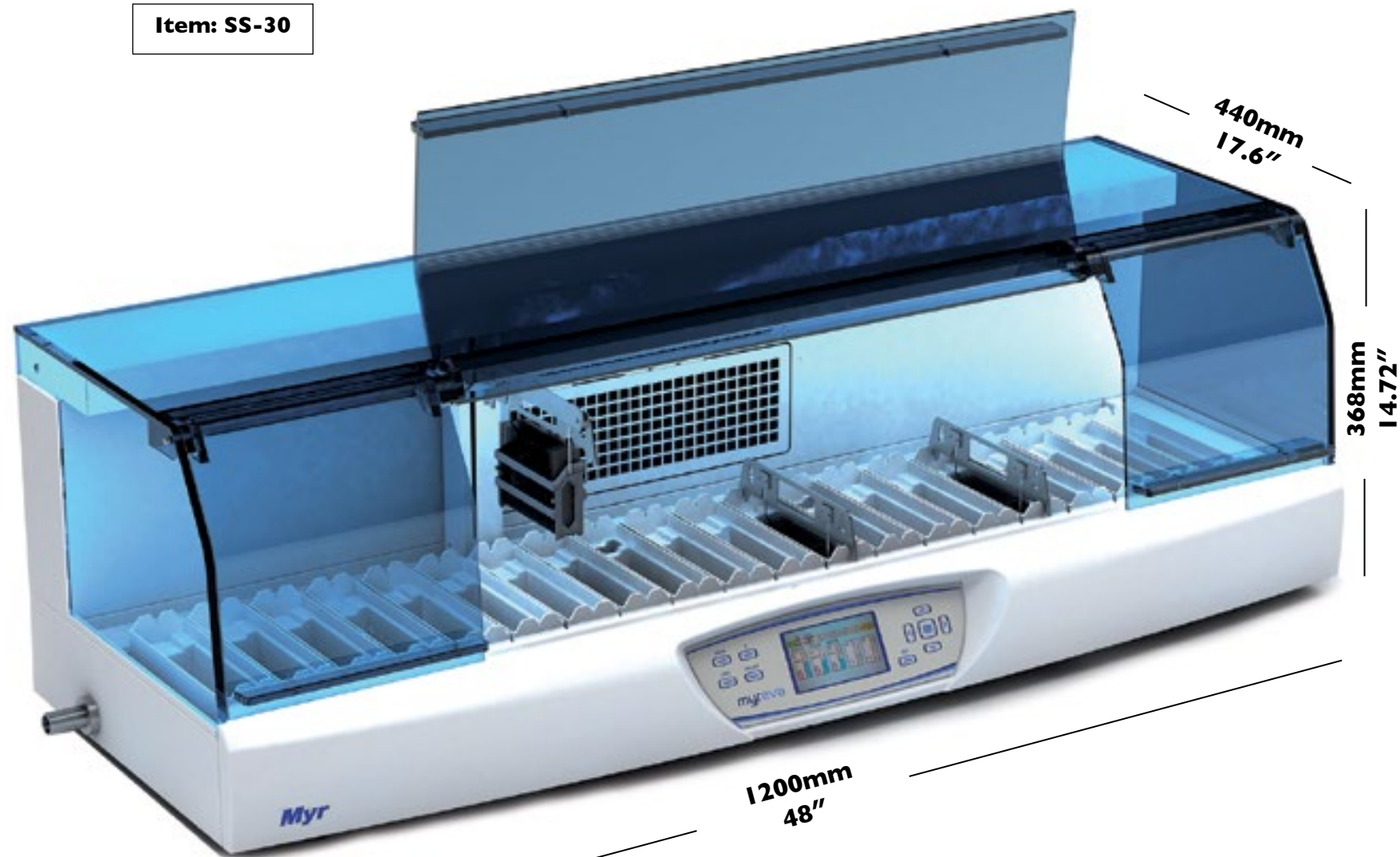

SS-30 Tissue Stainer

- Automated slide stainer (benchtop-unit) for simultaneous routine staining utilizing multiple slide racks with a variety of staining protocols.
- Instrument screen to continuously monitor the staining process.
- Independent programming in each station of selectable parameters.
- Display for continuous real-time visualization of the staining protocol state.
- Optional drying station.
- Fume extraction system with charcoal filter.
- Adapters available for most popular Coverslipper racks.
- MYREVA SS-30 is the perfect instrument for Hematoxylin and Eosin (H&E) and Papanicolau (Pap) staining. It also meets the requirements for special, user-specified staining protocols. User can load slide racks randomly, achieving efficiency and high throughput staining.



Spin Tissue Processor

Item: STP 120-3



STP 120 Spin Tissue Processor

CDI's Spin Tissue Processor STP 120 has been developed to meet the requirements of every single laboratory. The state-of-the-art technology and the unsurpassed processing method of the STP 120 qualifies it as the most successful Spin Tissue Processors ever. More than 2,000 units installed around the world confirm its leading position.

Tissue processing is a technique that uses alcohols to remove water from tissues and replace it with a medium that allows sectioning of tissue. Several methods are used to achieve this. CDI's Spin Tissue Processor STP 120 fulfills it in a patented and unique technique that combines several movements for the tissue to achieve perfect infiltration results.

STP 120-1: Standard instrument (basic instrument, 10 reagent vessels, 2 paraffin baths, 1 stainless steel basket for 120 cassettes, 1 tool kit and 1 user manual).

STP 120-2: STP 120-1 + fume extraction system with charcoal filter.

STP 120-3: STP 120-2 + 3rd paraffin station and 2nd basket for another 120 cassettes. (Pictured above)



SPIN TISSUE PROCESSOR

For over 30 years,
MYR has been among
the world's top
histology instrument
manufacturers.

ESPO Path Slide Printer

SMALL
FOOTPRINT.
HIGH
PERFORMANCE
RESULTS



Scaled to size

Slide Printer



The ESPO Path Slide Printer is a fast, wireless ready printer (OT Printer), printing at 20 slides per minute.

Item: ESPO-1

ESPO Path Slide Printer

The ESPO Path Slide Printer is a wireless ready printer (OT Printer). Despite its minimal size, it has two independent magazines for slides so that it can automatically print on two types of glass. A front loading feeder is also available to print on a different slide that can already be covered with tissue, without changing the magazines. This allows positive immune controls to be labeled directly on the slide.

Matsunami Japan (Established 1844)
ISO 13485

Dimensions
254mm (Height)
241mm (Long)
127mm (wide)
Weight
6.35kg



pfm Rotary 3004 M
(Manual)



pfm Rotary 3005 E
(Semi-Automatic)



pfm Rotary 3006 EM
(Fully Automatic)

BENEFITS

EXCELLENT SECTION QUALITY

The robust object and knife/blade holders operating in combination with the horizontal and vertical cross roller bearing system guarantee maximum stability. This unique technology and the quality of the materials used is reflected in the reliable and consistently high sectioning quality. Together with its ergonomic design these features make pfm Medical rotary microtomes ideal for situations with a high sample throughput.

SAFE OPERATION

When the object and knife are being mounted a handwheel lock is activated in order to prevent injury. If the handwheel lock is on, electronic versions of this device will visually indicate this on their display. A color-marked finger guard offers additional safety in the area of the knife/blade edge.

The handwheel of the pfm Rotary 3006 EM has a removable handle to ensure maximum user safety during motorized sectioning. Additionally, the device can be stopped immediately by pushing the emergency stop button.

SIMPLE OPERATION

pfm Medical electronic rotary microtomes are equipped with a modern touch screen system. The control panels and display elements are clearly arranged according to their functions. This makes the microtome easy and convenient to operate.

PRECISE ORIENTATION OF SAMPLES

The specimens can be aligned quickly and easily to the desired position as well as advanced to the knife/blade edge by using the object orientation system along the X/Y axes and the color coded tangible zero point setting.

SUITABLE FOR LARGE SAMPLES

pfm Medical's rotary microtomes are also suitable for use with large universal cassette clamps and can be converted without difficulty. This means that samples of different sizes can be processed depending on customer's requirements.

EASY CLEANING AND CARE

The surface of the housing is fully anodized and easy to clean. The waste produced during sectioning is caught by the integrated section waste tray and is then easy to discard. The section waste tray is also anodized and easy to clean.

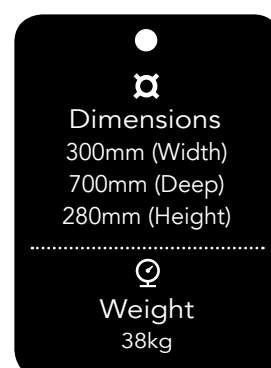
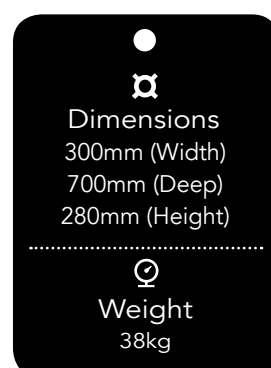
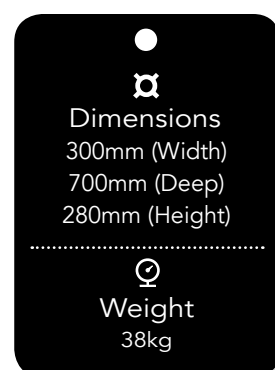

pfmmedical

Quality and Experience



Cologne, Germany

pfm Medical is headquartered in Cologne, Germany since 1971 and is a world leader in manufacturing high performance Microtome instruments for histology.



pfm Rotary



pfm Rotary 3004 M
(Manual)

Request a
Demonstration
for your Lab. 
Find a convenient day that
works for you and your team

Shown: Microtomes are designed, developed and built in pfm Medical's Dielheim, Germany facility

Embedding centers and spin tissue processors are shown being built near Barcelona, Spain.



ISO 9001 / 13485 certified company
Vidriers 19 -21, Pol. ind. La Cometa 43700
El Vendrell, Spain

EC-350 Embedding Center

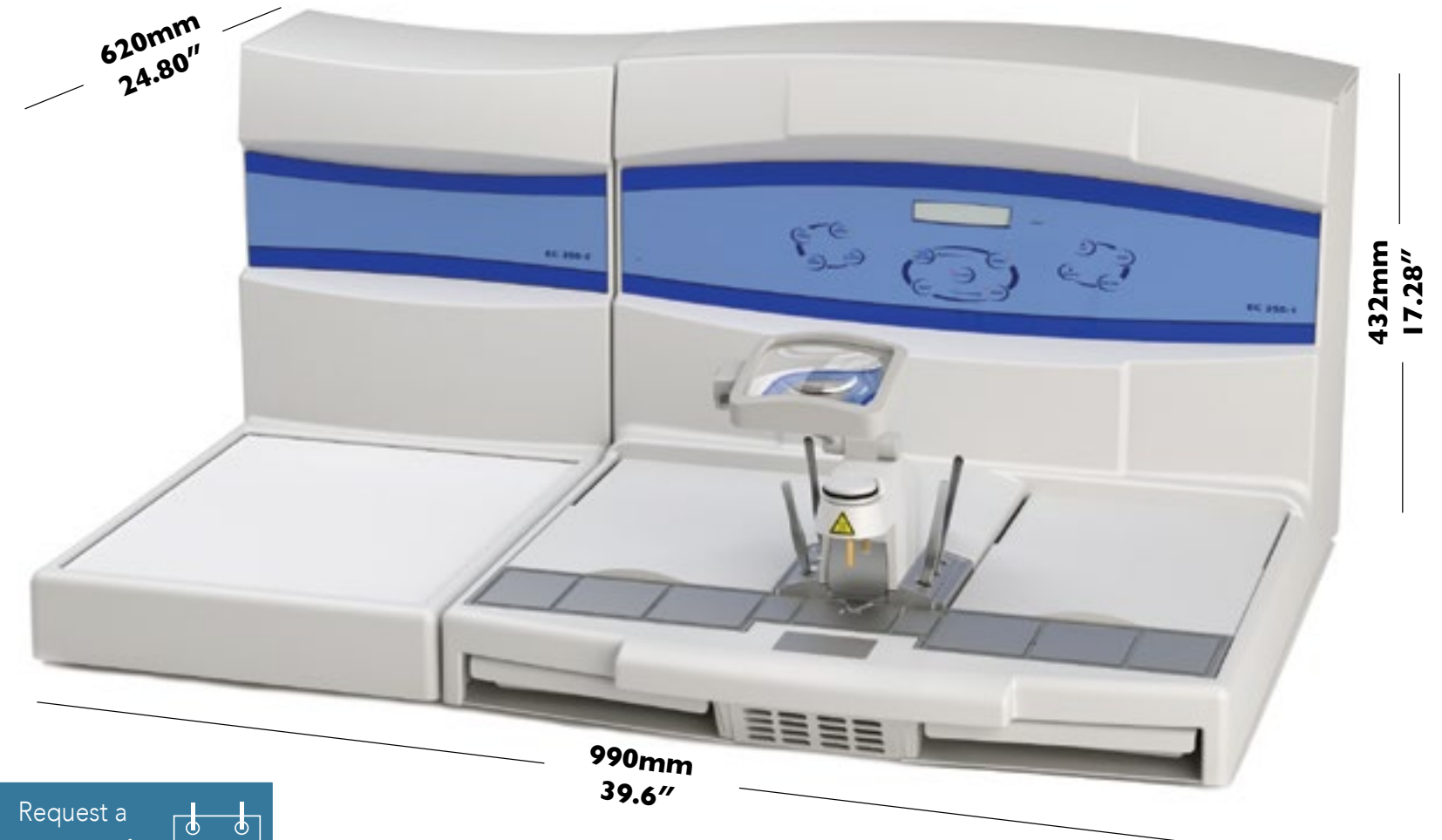

Request a
Demonstration
for your Lab.



Find a convenient day that
works for you and your team

Myr Modular Tissue Embedding Center **EC-350**

CDI's EC 350 is a modular paraffin embedding center featuring innovative design as well as easy operation. Different possibilities of setting up this instrument offer a simple and flexible adaptation to the working methods in the respective lab.

DISPENSING CONSOLE EC 350-I: EASY OPERATION WITH PERFECT ERGONOMY

The ergonomical arrangement of two large chambers, which can be heated independently of each other, for the storage of cassettes and molds allows a flexible working method.

A clearly and logically arranged operating panel allows for easy programming of the working times and temperatures.

The Cryo Console can operate connected to the dispensing unit or as stand-alone instrument.

Dimensions
432mm (Height)
990mm (Long)
620mm (Deep)

Weight
20kg

EC-500 Embedding Center



Request a **Demonstration** for your Lab. Find a convenient day that works for you and your team

Myr Modular Tissue Embedding Center EC-500

All elements in the modular paraffin embedding center are designed to achieve maximum efficiency and operating comfort.

The heated working surfaces are thermally insulated towards the operator and ergonomically shaped. Spacious, heated working area with a non-glare illumination with white LED lights.

Adjustable paraffin dispenser paddle to accommodate "Mega cassettes" and "Super Mega cassettes". Built in wax trimmer. Urgent biopsies can be embedded any time even in "standby mode".

STORAGE AND RESERVOIR ERGONOMICS AND FUNCTIONALITY FOR BETTER PROCESSING

Two storage chambers of large capacity, independently heated, for molds and cassettes. The paraffin reservoir has a capacity of 5 liters to guarantee continuous operation even at high specimen capacity.

Dimensions
405mm (Height)
1020mm (Long)
623mm (Deep)

Weight
61.2kg



BOEKEL WAX DISPENSER Item: 145600

Capacity ~1.25 Gallon(5L)

- Heated precise valve ensures a consistent flow of molten wax and can be locked in the open position
- Stainless steel outer casing and aluminum inner reservoir provides excellent thermal transfer and temperature control
- Rapid warm-up with an advanced safety overtemperature cut-off and inner reservoir screen

Dimensions
406mm (Height)
210mm (Deep)

Weight
61.2kg



CELLPATH WAX DISPENSER Item: JAU-0200-00A

Capacity ~4 Gallons (15L)

Two separate digital temperature controls, ultra-fast heating, and two non-drip taps allow tanks to be operated independently of one another which contributes to LEAN workflow and efficiency as one tank can be used to dispense wax while the other tank is in the process of melting pelletized wax.

Dimensions
435.50mm (Height)
362mm (Width)
420.50mm (Deep)

Weight
14kg



SLIDE DRYER Item: JAX-0401-00A

Designed to give maximum, rapid drying capacity for high workload laboratories without the risk of overheating specimens.

13 slide rack capacity (30 slides each) and a transparent lid with resistance hinges that allow users to easily position it at any angle.

- Optional LEAN Timer System and LEAN identifier rack
- Anti-microbial (Silver Ion)

Dimensions
465mm (Height)
335mm (Long)
320mm (Deep)

Weight
14.5kg

INDEX

INDEX

MOHS related products Pages 21, 41, 42, 151-156, 175-176, 237-238, 243-246, 352



Description	Page	Description	Page	Description	Page	Description	Page
A							
3-Stain Dip (Quick) Kit	236	Biopsy paper, Bio-Paper™ wraps	47	Counter top barrier sheets	208	Dissection instruments	51-58
4 slide jar, pre-filled with 95% ethyl	340	Biopsy paper, Tri-fold™, folding biopsy paper	49	Coverglass	172-173	Double edge blade handle, blade	30
Acetone	90	Biopsy Punches, disposable, bevel® and Miltex®	42	Coverslip	173	E	
Acid Alcohol 1%	234	Blade, dermatology, Miltex®	41	Coverslipping tape, Germany	174	Embedding beads	143
Air monitor, Vapor Badges™	212	Blade, double edge blade	30	Cryo-Stains™	237-238	Embedding centers	361-363
Alcohols	93-96	Blade, single edge blade	30	Cryostat, heat extractor	156	Enzymatic instrument cleaner, Restore 4™	58
Alcohols, Pureview® (flex)	95-96	Bladex™ scalpel exchange device	35-36	Cryostat, lubricating oil	156	Eosin Y, & w/ phloxine	233
Aldehyde neutralizer, Formalex® Green liquid	215	Block softener, Soft-Cut™	142	Cryostat, tissue chucks	153-154	Eosin, Cryo (Optimized for Frozen)	238
Aldehyde neutralizer, N-15™ powder	213-214	Bluing, H&E	226-227, 233, 238, 334	Curettes, disposable bevel®	41	Hematoxylin, Cryo (optimized for frozen)	237
Aldehyde spill control granules, Polyform-F	215	Bouin's fixative	72	Cutting board, Bio-Board™ disposable	62	Hematoxylin, Dermatoxylin™	235
Ammonium hydroxide	239	Brushes, paraffin and frozen section	144	Cutting boards	61	Hematoxylin, Endure™ Series	227-228
Antibodies	288-305	C		Cytology	329-346	Hematoxylin, Gill 1,2,3, Harris, Mayer's	231-232
Applicators, cotton tip, foam, wood	22	Cassettes	99-120	Cytology brush, Rovers®	332	Hematoxylin, HI-Plus™, H-2 Plus™	222
B							
B-5 Substitute, B-5 Sub	72	Cassettes, biopsy	101, 109-111	Cytology brush, Snap-Tip™	333	Hematoxylin, Type R & V	229-230
Bard-Parker, scalpel blades	28	Cassettes, laser printer	101, 119-120	Cytology brush, Wallach Papette®	332	Histo-cool™, block cooling tray	143
Base mold release spray, BM2™	155	Cassettes, routine	101, 106-108	Cytology counter stains	335	Histology Gel, Matrix SPG™, Specimen Processing Gel	45-46
Base molds, Archimedes™ and Atomic™ non-stick metal	147-149	Cassettes, Primera	101, 118	Cytology fixative, CF2	337	Hydrochloric acid	239
Base molds, disposable	150	Cassettes, specialty	101, 112-117	Cytology fixative, Lyse-Red™	338	I	
Base molds, metal traditional	149	Cassettes, super large	116	Cytology fixative, Pap-Spray™	339	Immunohistochemistry (IHC)	288-328
Base Molds, super large cassette	116	CellSafe™, biopsy cassette insert	44	Cytology fixative, Saccomanno	337	IHC, Ancillaries	328
Bevel™ scalpel blades	25-26	Centrifuge tubes	343	Cytology funnels	344-346	IHC, Control slides	319-326
Biohazard, transport bags	194	Cervical brushes	331-333	Cytology Stains	231, 232, 334-336	IHC, Detection kits	308-318
Biohazard, waste bags	193	Chromagen systems, IHC	317-318	Cytology, liquid-based	341-342	Insight LLD™, specimen board	24
Biopsy bags, mesh	44	Chucks, Blue (see disposable underpads)	60	Cytology, liquid-based	341-342	K	
Biopsy bags, paper	50	Clarifier, H&E	226, 234, 237, 334	Cytology counter stains	335	Kim wipes	208
Biopsy, Dermal curette, bevel®	41	Cleanerol™ spray	209	Cytology fixative, CF2	337	Knives, grossing	38-40
Biopsy pads, foam	48	Clearing Agents	89-98	Cytology fixative, Lyse-Red™	338	L	
		Control slides, histology	276	Cytology fixative, Pap-Spray™	339	Lab wipes, see Zorbentz	207
		Control slides, IHC	319-326	Cytology fixative, Saccomanno	337	Labels, consecutive pre-numbered	285-286
		Coplin jars, plastic, glass	243-244	Cytology funnels	344-346	Labels, custom, peel and stick	283-284
				Cytology Stains	231, 232, 334-336		
				Cytology, liquid-based	341-342		
				Cytology counter stains	335		
				Cytology fixative, CF2	337		
				Cytology fixative, Lyse-Red™	338		
				Cytology fixative, Pap-Spray™	339		
				Cytology fixative, Saccomanno	337		
				Cytology funnels	344-346		
				Cytology Stains	231, 232, 334-336		
				Cytology, liquid-based	341-342		
				Cytology counter stains	335		
				Cytology fixative, CF2	337		
				Cytology fixative, Lyse-Red™	338		
				Cytology fixative, Pap-Spray™	339		
				Cytology fixative, Saccomanno	337		
				Cytology funnels	344-346		
				Cytology Stains	231, 232, 334-336		
				Cytology, liquid-based	341-342		
				Cytology counter stains	335		
				Cytology fixative, CF2	337		
				Cytology fixative, Lyse-Red™	338		
				Cytology fixative, Pap-Spray™	339		
				Cytology fixative, Saccomanno	337		
				Cytology funnels	344-346		
				Cytology Stains	231, 232, 334-336		
				Cytology, liquid-based	341-342		
				Cytology counter stains	335		
				Cytology fixative, CF2	337		
				Cytology fixative, Lyse-Red™	338		
				Cytology fixative, Pap-Spray™	339		
				Cytology fixative, Saccomanno	337		
				Cytology funnels	344-346		
				Cytology Stains	231, 232, 334-336		
				Cytology, liquid-based	341-342		
				Cytology counter stains	335		
				Cytology fixative, CF2	337		
				Cytology fixative, Lyse-Red™	338		
				Cytology fixative, Pap-Spray™	339		
				Cytology fixative, Saccomanno	337		
				Cytology funnels	344-346		
				Cytology Stains	231, 232, 334-336		
				Cytology, liquid-based	341-342		
				Cytology counter stains	335		
				Cytology fixative, CF2	337		
				Cytology fixative, Lyse-Red™	338		
				Cytology fixative, Pap-Spray™	339		
				Cytology fixative, Saccomanno	337		
				Cytology funnels	344-346		
				Cytology Stains	231, 232, 334-336		
				Cytology, liquid-based	341-342		
				Cytology counter stains	335		
				Cytology fixative, CF2	337		
				Cytology fixative, Lyse-Red™	338		
				Cytology fixative, Pap-Spray™	339		
				Cytology fixative, Saccomanno	337		
				Cytology funnels	344-346		
				Cytology Stains	231, 232, 334-336		
				Cytology, liquid-based	341-342		
				Cytology counter stains	335		
				Cytology fixative, CF2	337		
				Cytology fixative, Lyse-Red™	338		
				Cytology fixative, Pap-Spray™	339		
				Cytology fixative, Saccomanno	337		
				Cytology funnels	344-346		
				Cytology Stains	231, 232, 334-336		
				Cytology, liquid-based	341-342		
				Cytology counter stains	335		
				Cytology fixative, CF2	337		
				Cytology fixative, Lyse-Red™	338		
				Cytology fixative, Pap-Spray™	339		
				Cytology fixative, Saccomanno	337		
				Cytology funnels	344-346		
				Cytology Stains	231, 232, 334-336		
				Cytology, liquid-based	341-342		
				Cytology counter stains	335		
				Cytology fixative, CF2	337		
				Cytology fixative, Lyse-Red™	338		
				Cytology fixative, Pap-Spray™	339		
				Cytology fixative, Saccomanno	337		
				Cytology funnels	344-346		
				Cytology Stains	231, 232, 334-336		
				Cytology, liquid-based	341-342		
				Cytology counter stains	335		
				Cytology fixative, CF2	337		
				Cytology fixative, Lyse-Red™	338		
				Cytology fixative, Pap-Spray™	339		
				Cytology fixative, Saccomanno	337		
				Cytology funnels	344-346		
				Cytology Stains	231, 232, 334-336		
				Cytology, liquid-based	341-342		
				Cytology counter stains	335		
				Cytology fixative, CF2	337		
				Cytology fixative, Lyse-Red™	338		
				Cytology fixative, Pap-Spray™	339		
				Cytology fixative, Saccomanno	337		
				Cytology funnels	344-346		
				Cytology Stains	231, 232, 334-336		
				Cytology, liquid-based	341-342		
				Cytology counter stains	335		
				Cytology fixative, CF2	337		
				Cytology fixative, Lyse-Red™	338		
				Cytology fixative, Pap-Spray™	339		
				Cytology fixative, Saccomanno	337		
				Cytology funnels	344-346		
				Cytology Stains	231, 232, 334-336		
				Cytology, liquid-based	341-342		
				Cytology counter stains	335		
				Cytology fixative, CF2	337		
				Cytology fixative, Lyse-Red™	338		
				Cytology fixative, Pap-Spray™	339		
				Cytology fixative, Saccomanno	337		
				Cytology funnels	344-346		
				Cytology Stains	231, 232, 334-336		
				Cytology, liquid-based	341-342		
				Cytology counter stains	335		
				Cytology fixative, CF2	337		
				Cytology fixative, Lyse-Red™	338		
				Cytology fixative, Pap-Spray™	339		
				Cytology fixative, Saccomanno	337		
				Cytology funnels	344-346		
				Cytology Stains	231, 232, 334-336		
				Cytology, liquid-based	341-342		
				Cytology counter stains	335		
				Cytology fixative, CF2	337		
				Cytology fixative, Lyse-Red™	338		
				Cytology fixative, Pap-Spray™	339		
				Cytology fixative, Saccomanno	337		
				Cytology funnels	344-346		
				Cytology Stains	231, 232, 334-336		
				Cytology, liquid-based	341-342		
				Cytology counter stains	335		
				Cytology fixative, CF2	337		
				Cytology fixative, Lyse-Red™	338		
				Cytology fixative, Pap-Spray™	339		
				Cytology fixative, Saccomanno	337		
				Cytology funnels	344-346		
				Cytology Stains	231, 232, 334-336		
				Cytology, liquid-based	341-342		
				Cytology counter stains	335		
				Cytology fixative, CF2	337		
				Cytology fixative, Lyse-Red™	338		
				Cytology fixative, Pap-Spray™	339		
				Cytology fixative, Saccomanno	337		
				Cytology funnels	344-346		
				Cytology Stains	231, 232, 334-336		
				Cytology, liquid-based	341-342		
				Cytology counter stains	335		
				Cytology fixative, CF2	337		

INDEX

Description	Page	Description	Page
S Continued		T	
Slide Mailers, flat, chipboard, plastic	188-190	ThinLayer™ cell lysing solution, Non-gyn	342
Slide printer ribbon	282	ThinLayer™ cell preserve solution, vials, quart	342
Slide printer, ESPO	355-356	ThinLayer™ cytology filters, Non-gyn	341
Slide storage, 25, 50, 100 box	191-192	Timer, LCD	245
Slide storage, cryo storage	192	Tissue Capture Pen	307
Special stain components	265-266	Tissue dye setting solution, Ink Aid™	4
Special stain kits	253-275	Tissue marking dyes, applicators	22
Specimen container empty	85	Tissue marking dyes, CDI's Tissue Marking Dye®	3-16, 21
Specimen container, Life Latch®	88	Tissue marking dyes, SterileMargin™	19-20
Specimen container, Pre-fill	81-82	Tissue marking dyes, trays	17-18
Specimen container, Press 'n seal lids	87	Tissue processor, spin version	354
Spill response kit	216	Tissue section adhesive, Ribbon™	142
Spout, gallon, EZ Pour	247	Tissue Tamper	145
Stainer, automated	351-353	Trimming blades, bevel®	37-38
Staining dishes, racks, jars, accessories	243-246	Trimming blade handles and accessories	38
Staining, slide dippers	245-246	Tris buffered saline, w/ or w/o tween concentrate 20X	305
Staining, timer	245	W	
Stains, 3-stain, Differential Quick Stain	236	Wallach Papette®	332
Stains, reagents	239-240	Wash bottles, squeeze	249-250
Stains, h&e	222-242	Water	248
Stains, powdered	241-242	Water Baths	349-350
Stains, special stain kits	253-275	X	
Stains, special stain components	265-266	Xylene	91-92
Storage File, cassette and slide dividers	179,185	Xylene Substitute, Clear Away Citrus™	91-92
Storage File, cassettes, plastic, cardboard	182, 184-186	Xylene Substitute, Zero Xylene™	91-92
Storage File, foam blocks	182	Z	
Storage File, microscope, plastic, metal and cardboard	179, 181, 183	Zorbentz™	207
Swann-Morton, scalpel blades	27		
T			
Tampers, tissue	145		
Teasing needles	60		

TRADEMARKS

CANCER DIAGNOSTICS INC.

3-Stain Dip Kit™
 60 Below™
 660+, 615™, H&E Stains
 All Fix™
 Archimedes™
 Archimedes™ Atomic™
 AutoFrost®
 AutoSette™
 B-5 Sub™
 bevel® biopsy punch
 bevel® dermal curette
 bevel® microtome blades
 bevel® scalpel blades
 bevel® trimming knives
 Bio-Board™, Disposable Dissection Board
 Bio-Paper™, Biopsy Wraps
 BlockFile™ Storage Files
 BM2™ Base Mold Release
 Calfor®
 CDI's Tissue Marking Dyes®
 CDI's Tissue Marking Dyes® Applicator Series™
 CF2™, Cytology Fixative
 Cleanerol™
 Clear Away Citrus™
 ClearLite Plus™
 CoverSeal™
 Cryo-Hematoxylin™, Cryo-Eosin™
 Cryo-Bluing™
 Cytology-Clarifier™
 CytoStain-Bluing™
 DehCL® Decalcifier
 Deoderol™
 Dermatoxylin™, Dermosin™
 EA-OG, CytoStain™
 endure™
 Etch-Mark™
 Fast-Fix™, Rapid Tissue Fixative
 Finger Scalpels™
 Focus™ Clarifier
 FrozenFix™
 Fusion Micro™
 Fusion Ultra™
 H1 Plus™, H2 Plus™ Hematoxylin
 i-Shield™
 Immuno-4™
 Ink-Aid™

CANCER DIAGNOSTICS INC.

Insight LLD™, Lesion Locating Device
 Invisi-Shields™
 Katana™ Microtome Blades
 Klick-Top™
 LaserSettes™
 Lipo-Fix™
 Luben™ Lubricant
 Lyse-Red™
 Matrix SPG™
 Moist Mark Plus™
 N-15™, Formalin Neutralizer Powder
 Nail-RX™
 Niter-Cal®
 Pap Spray™
 PH Blue™
 Pre-Filled PAK™ (Pre-Filled Formalin)
 Pre-Freeze™
 Prostate-Pak™
 PureAffin®, e™, i™, x™, r53™, r56™, Blue™, I™, 2™, Bloxx™
 PureView®
 Restore4™, Enzymatic Cleaner
 Reveal®
 Ribbon™ Tissue Section Adhesive
 Rinse-HD™
 SBC Blue™
 Slide Genie™
 Snap-Tip™, Cervical Brush
 SoftCut™
 Stealth™
 SterileMargin®
 Super Scalpel™
 SuperLite™ Storage Files
 ThinLayer™
 ThinSette™
 Tri-Fold Biopsy Papers™
 TriCide-10™
 Type V™, Type R™, H&E Stains
 UltraFreeze™, OCT Compound
 UltraSlips™
 Vapor-Pad™
 Vortex™, Histology Cassettes
 Wax-Off™
 Zero-Xylene™
 Zorbentz™

OTHERS

Accu-Edge® (Sakura Finetek, USA)
 Bard-Parker®, Rib-Back™ (Aspen Surgical)
 Bladex™ (Bladex, Inc.)
 Cavicide® (Metrex Research, LLC.)
 CitriSolv® (Decon Laboratories)
 CoreDish™ (Simport Scientific)
 CytoSep™ (Sakura Finetek USA)
 CytoSpin® (Thermo Scientific)
 Cyto-Tek® (Sakura Finetek USA)
 EC-350, EC-500, STP-120 (Especialidades Médicas Myr, S.L.)
 Encore® (Crescent Blade)
 Fan Pad G.L.™ (American Bio Safety, Inc.)
 Feather® (Feather Safety Razor Co., Ltd.)
 Formalex®Green (American Bio Safety, Inc.)
 Gem® (Personna, American Safety Razor Co.)
 Histo-Gel™ (Richard-Allan Scientific Co.)
 Histo-Loc™ (Richard-Allan Scientific Co.)
 HistoSette™ (Simport Scientific)
 HP35™, MX35™ (Thermo Scientific)
 Infinity™, Extremus™, Silver™ (C.L. Sturkey, Inc.)
 KimWipes®, KimTech Science™ (Kimberly Clark Worldwide)
 LaserTrack™ PH1, PH6 (General Data Healthcare, Inc.)
 MarginMap® (BeeKley Medical)
 MicroFlex® (Ansell Healthcare)
 Miltex® BioBlade (Integra® Miltex®)
 Neo® (Matsunami Glass Ind., Ltd.)
 Nova™, Pulsar™ (FaTech Diagnostics Europe BV)
 ParaFilm® (Bemis NA)
 pfm rotary (pfm Medical)
 Primera Signature® (Primera Technology, Inc.)
 Qlicksmart® (Qlicksmart)
 Rovers®, Cervex-Brush® (Rovers Medical Devices)
 SmartStep® (Wellness Mats)
 SuperFrost® (Erie Scientific)
 Swann-Morton® (Swann-Morton, Ltd.)
 Tomo® (Matsunami Glass Ind., Ltd.)
 Vintage™, Reserve™ H&E Stains (SLMP, LLC.)
 Wallach Papette® (Wallach Surgical Devices)
 Surgipath® Blue Ribbon™ (Leica Biosystems)
 Surgipath® EM-400™ (Leica Biosystems)
 Surgipath® Infiltration Medium (IF-200™) (Leica Biosystems)
 Surgipath®Formula-R™ (Leica Biosystems)
 Paraplast®, Paraplast® Plus, Paraplast® X-tra (Leica Biosystems)
 Leica Peloris™ (Leica Biosystems)
 Surgipath® SelecTech™ Series (Leica Biosystems)